

# User's Guide

## GS1900 Series

GbE Smart Managed Switch

### Default Login Details

IP Address	http://192.168.1.1 (In-band ports)
User Name	admin
Password	1234

Version 2.70 Edition 2, 04/2022

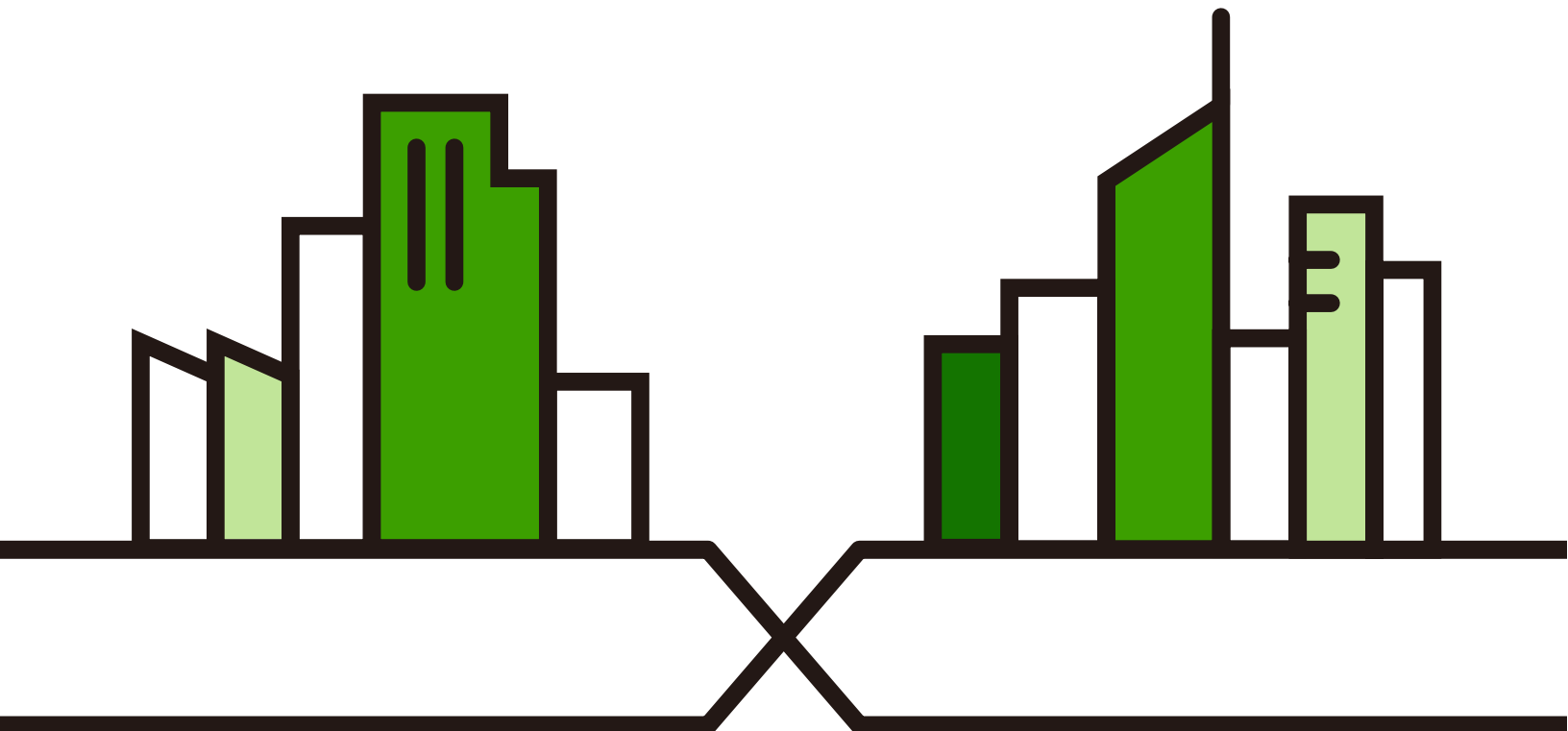

---

## **IMPORTANT!**

### **READ CAREFULLY BEFORE USE.**

### **KEEP THIS GUIDE FOR FUTURE REFERENCE.**

Screenshots and graphics in this book may differ slightly from your product due to differences in your product firmware or your computer operating system. Every effort has been made to ensure that the information in this manual is accurate.

Note: This guide is a reference for a series of products. Therefore some features or options in this guide may not be available in your product.

Note: It is recommended you use the Web Configurator to configure the Switch.

### **Related Documentation**

- Online Help  
Click the help link for a description of the fields in the Switch menus.
- More Information  
Go to <https://businessforum.zyxel.com> for product discussions.
- Go to <support.zyxel.com> to find other information on the Switch.



# Document Conventions

## Warnings and Notes

These are how warnings and notes are shown in this guide.

**Warnings tell you about things that could harm you or your device.**









Note: Notes tell you other important information (for example, other things you may need to configure or helpful tips) or recommendations.

## Syntax Conventions

- All models may be referred to as the "Switch" in this guide.
- Product labels, screen names, field labels and field choices are all in **bold** font.
- A right angle bracket ( > ) within a screen name denotes a mouse click. For example, **Configuration > System > Information** means you first click **Configuration** in the navigation panel, then the **System** sub menu and finally the **Information** tab to get to that screen.

## Icons Used in Figures

Figures in this user guide may use the following generic icons. The Switch icon is not an exact representation of your device.

Switch 	Generic Switch 	Generic Router 
IP Camera 	Firewall 	Cell Tower 
Printer 	Server 	

# Contents Overview

<b>User's Guide</b> .....	<b>16</b>
Getting to Know Your Switch .....	17
Hardware Installation and Connection .....	25
Hardware Overview .....	31
ZON Utility .....	45
Web Configurator .....	50
Getting Started .....	61
<b>Technical Reference</b> .....	<b>73</b>
Monitor: System .....	74
Monitor: Port .....	77
Monitor: VLAN .....	86
Monitor: MAC Table .....	92
Monitor: Link Aggregation .....	95
Monitor: Loop Guard .....	97
Monitor: Multicast .....	100
Monitor: Spanning Tree .....	104
Monitor: LLDP .....	110
Monitor: Security .....	114
Monitor: Management .....	117
Configuration: System .....	120
Configuration: Port .....	125
Configuration: VLAN .....	138
Configuration: MAC Table .....	149
Configuration: Link Aggregation .....	152
Configuration: Loop Guard .....	158
Configuration: Mirror .....	161
Configuration: Time Range Group .....	164
Configuration: Multicast .....	169
Configuration: Spanning Tree .....	177
Configuration: LLDP .....	186
Configuration: QoS .....	198
Configuration: Security .....	207
Configuration: AAA .....	216
Configuration: Management .....	221
Maintenance .....	238
Troubleshooting .....	250

# Table of Contents

<b>Document Conventions</b> .....	<b>3</b>
<b>Contents Overview</b> .....	<b>4</b>
<b>Table of Contents</b> .....	<b>5</b>
<b>Part I: User's Guide</b> .....	<b>16</b>
<b>Chapter 1</b>	
<b>Getting to Know Your Switch</b> .....	<b>17</b>
1.1 Introduction .....	17
1.1.1 Hardware Version Information .....	17
1.1.2 Hardware Comparison .....	19
1.2 Example Applications .....	20
1.2.1 PoE Example Application .....	20
1.2.2 Backbone Example Application .....	21
1.2.3 Bridging or Fiber-optic Uplink Example Application .....	21
1.2.4 Gigabit Ethernet to the Desktop .....	22
1.2.5 IEEE 802.1Q VLAN Application Example .....	22
1.2.6 IPv6 Support .....	23
1.3 Ways to Manage the Switch .....	23
1.4 Good Habits for Managing the Switch .....	24
<b>Chapter 2</b>	
<b>Hardware Installation and Connection</b> .....	<b>25</b>
2.1 Safety Precautions .....	25
2.2 Installation Scenarios .....	25
2.3 Desktop Installation Procedure .....	26
2.4 Wall Mounting .....	26
2.4.1 Wall-mounted Installation Requirement .....	27
2.5 Rack Mounting .....	28
2.5.1 Rack-mounted Installation Requirement .....	28
2.5.2 Attaching the Mounting Brackets to the Switch .....	29
2.5.3 Mounting the Switch on a Rack .....	29
<b>Chapter 3</b>	
<b>Hardware Overview</b> .....	<b>31</b>
3.1 Front Panel Connections .....	31

---

3.1.1 Ethernet Ports .....	33
3.1.2 SFP Slots .....	33
3.1.3 PoE Mode Button .....	36
3.2 Rear Panel .....	36
3.2.1 Grounding .....	38
3.2.2 Power Connection .....	40
3.3 LEDs .....	41
3.4 Resetting the Switch .....	43
3.5 Rebooting the Switch .....	44
<b>Chapter 4</b>	
<b>ZON Utility .....</b>	<b>45</b>
4.1 Zyxel One Network (ZON) Utility .....	45
4.1.1 Requirements .....	45
4.1.2 Run the ZON Utility .....	46
<b>Chapter 5</b>	
<b>Web Configurator.....</b>	<b>50</b>
5.1 Overview .....	50
5.2 Access .....	50
5.3 Navigating the Web Configurator .....	52
5.3.1 Title Bar .....	52
5.3.2 Navigation Panel .....	53
<b>Chapter 6</b>	
<b>Getting Started .....</b>	<b>61</b>
6.1 Overview .....	61
6.1.1 What You Can Do in this Chapter .....	61
6.2 Getting Started .....	61
6.2.1 Wizard .....	62
<b>Part II: Technical Reference.....</b>	<b>73</b>
<b>Chapter 7</b>	
<b>Monitor: System.....</b>	<b>74</b>
7.1 Overview .....	74
7.1.1 What You Can Do in this Chapter .....	74
7.2 IP Settings .....	74
7.2.1 IPv4 Settings .....	74
7.2.2 IPv6 Settings .....	75
7.3 Information .....	75

<b>Chapter 8</b>	
<b>Monitor: Port</b>	<b>77</b>
8.1 Overview	77
8.1.1 What You Can Do in this Chapter	77
8.2 Port Settings	77
8.2.1 Status	77
8.2.2 Port Counters	78
8.2.3 Bandwidth Utilization	80
8.3 PoE Settings	81
8.4 Bandwidth Management	83
8.4.1 Bandwidth Control	83
8.5 Storm Control	84
<b>Chapter 9</b>	
<b>Monitor: VLAN</b>	<b>86</b>
9.1 Overview	86
9.1.1 What You Can Do in this Chapter	86
9.2 VLAN Settings	86
9.2.1 VLAN	86
9.2.2 Port	87
9.2.3 VLAN Port	88
9.3 Guest VLAN	89
9.4 Voice VLAN	90
<b>Chapter 10</b>	
<b>Monitor: MAC Table</b>	<b>92</b>
10.1 Overview	92
10.1.1 What You Can Do in this Chapter	93
10.2 MAC Table	93
<b>Chapter 11</b>	
<b>Monitor: Link Aggregation</b>	<b>95</b>
11.1 Overview	95
11.1.1 What You Can Do in this Chapter	95
11.2 Link Aggregation	95
<b>Chapter 12</b>	
<b>Monitor: Loop Guard</b>	<b>97</b>
12.1 Overview	97
12.1.1 What You Can Do in this Chapter	98
12.2 Loop Guard	98

---

<b>Chapter 13</b>	
<b>Monitor: Multicast</b> .....	<b>100</b>
13.1 Overview .....	100
13.1.1 What You Can Do in this Chapter .....	100
13.2 IGMP Settings .....	100
13.2.1 VLAN .....	100
13.2.2 Statistics .....	101
13.2.3 Group .....	102
13.2.4 Router .....	103
<b>Chapter 14</b>	
<b>Monitor: Spanning Tree</b> .....	<b>104</b>
14.1 Overview .....	104
14.1.1 What You Can Do in this Chapter .....	104
14.2 Spanning Tree .....	104
14.2.1 CIST Settings .....	104
14.2.2 CIST Port .....	105
14.2.3 MST Settings .....	106
14.2.4 MST Port .....	107
14.2.5 STP Statistics .....	108
<b>Chapter 15</b>	
<b>Monitor: LLDP</b> .....	<b>110</b>
15.1 Overview .....	110
15.1.1 What You Can Do in this Chapter .....	110
15.2 LLDP Settings .....	110
15.2.1 Statistics Settings .....	110
15.2.2 Remote Information .....	111
15.2.3 Overloading .....	112
<b>Chapter 16</b>	
<b>Monitor: Security</b> .....	<b>114</b>
16.1 Overview .....	114
16.1.1 What You Can Do in this Chapter .....	114
16.2 Port Security .....	114
16.3 802.1X Security Settings .....	115
16.3.1 Port Settings .....	115
16.3.2 Authenticated Hosts .....	116
<b>Chapter 17</b>	
<b>Monitor: Management</b> .....	<b>117</b>
17.1 Overview .....	117
17.1.1 What You Can Do in this Chapter .....	117



17.2 Syslog .....	117
17.3 Error Disable .....	118
<b>Chapter 18</b>	
<b>Configuration: System .....</b>	<b>120</b>
18.1 Overview .....	120
18.1.1 What You Can Do in this Chapter .....	120
18.2 IP Settings .....	120
18.2.1 IPv4 Settings .....	120
18.2.2 IPv6 Settings .....	121
18.3 Time .....	122
18.3.1 System Time Settings .....	122
18.3.2 SNTP Server Settings .....	123
18.4 Information .....	123
18.4.1 System Information Settings .....	123
<b>Chapter 19</b>	
<b>Configuration: Port .....</b>	<b>125</b>
19.1 Overview .....	125
19.1.1 What You Can Do in this Chapter .....	125
19.2 Port Settings .....	125
19.2.1 Port .....	125
19.2.2 Port Edit .....	126
19.3 EEE Settings .....	127
19.3.1 EEE .....	127
19.3.2 EEE Edit .....	128
19.4 PoE Settings .....	129
19.4.1 Global Settings .....	129
19.4.2 Port Settings .....	129
19.4.3 PoE Edit .....	131
19.5 Bandwidth Management .....	134
19.5.1 Bandwidth Control .....	134
19.5.2 Port Rate Edit .....	135
19.6 Storm Control .....	135
19.6.1 Port Settings .....	136
19.6.2 Port Edit .....	136
<b>Chapter 20</b>	
<b>Configuration: VLAN .....</b>	<b>138</b>
20.1 Overview .....	138
20.1.1 What You Can Do in this Chapter .....	138
20.2 VLAN Settings .....	139
20.2.1 VLAN .....	139

20.2.2 VLAN Add .....	139
20.2.3 Port Settings .....	140
20.2.4 Port Edit .....	141
20.2.5 VLAN Port .....	141
20.3 Guest VLAN .....	143
20.3.1 Global Settings .....	143
20.3.2 Port Settings .....	144
20.3.3 Port Edit .....	144
20.4 Voice VLAN .....	145
20.4.1 Global Settings .....	145
20.4.2 OUI Settings .....	146
20.4.3 OUI Add or Edit .....	147
20.4.4 Port Settings .....	147
20.4.5 Port Edit .....	148
<b>Chapter 21</b>	
<b>Configuration: MAC Table.....</b>	<b>149</b>
21.1 Overview .....	149
21.1.1 What You Can Do in this Chapter .....	149
21.1.2 Static MAC .....	149
21.1.3 Static MAC Address .....	150
21.1.4 Filtering MAC Address .....	150
21.1.5 Filtering MAC Address (Add) .....	151
21.1.6 Dynamic Age .....	151
<b>Chapter 22</b>	
<b>Configuration: Link Aggregation .....</b>	<b>152</b>
22.1 Overview .....	152
22.1.1 What You Can Do in this Chapter .....	152
22.2 Link Aggregation .....	152
22.2.1 Global Settings .....	152
22.2.2 LAG Management .....	153
22.2.3 LAG Management (Add) .....	154
22.2.4 LAG Port .....	155
22.2.5 LAG Port Edit .....	155
22.2.6 LACP Port .....	156
22.2.7 LACP Port Edit .....	157
<b>Chapter 23</b>	
<b>Configuration: Loop Guard .....</b>	<b>158</b>
23.1 Overview .....	158
23.2 Loop Guard .....	158
23.2.1 Global Settings .....	158

23.2.2 Loop Guard Port .....	159
23.2.3 Port Edit .....	159
<b>Chapter 24</b>	
<b>Configuration: Mirror.....</b>	<b>161</b>
24.1 Overview .....	161
24.2 Mirror Settings .....	161
24.2.1 Mirror .....	161
<b>Chapter 25</b>	
<b>Configuration: Time Range Group .....</b>	<b>164</b>
25.1 Overview .....	164
25.1.1 What You Can Do .....	164
25.2 Time Range Group .....	164
25.2.1 Time Range Group Settings .....	164
25.2.2 Time Range Add .....	165
25.2.3 Time Range Edit .....	166
<b>Chapter 26</b>	
<b>Configuration: Multicast .....</b>	<b>169</b>
26.1 Overview .....	169
26.2 IGMP Settings .....	169
26.2.1 Global Settings .....	169
26.2.2 VLAN Settings .....	170
26.2.3 Edit IGMP .....	171
26.2.4 Router Port .....	172
26.2.5 Add or Edit Router Port .....	172
26.2.6 Profile Settings .....	173
26.2.7 Add or Edit Profile .....	174
26.2.8 Throttling Settings .....	174
26.2.9 Edit Throttling .....	175
<b>Chapter 27</b>	
<b>Configuration: Spanning Tree .....</b>	<b>177</b>
27.1 Overview .....	177
27.2 Spanning Tree .....	177
27.2.1 Global Settings .....	177
27.2.2 STP Port .....	178
27.2.3 STP Port Edit .....	179
27.2.4 CIST Settings .....	180
27.2.5 CIST Port .....	181
27.2.6 CIST Port Edit .....	181
27.2.7 MST Settings .....	182

27.2.8 Add or Edit MST .....	183
27.2.9 MST Port Settings .....	183
27.2.10 MST Port Edit .....	184
<b>Chapter 28</b>	
<b>Configuration: LLDP .....</b>	<b>186</b>
28.1 Overview .....	186
28.2 LLDP Settings .....	186
28.2.1 Global Settings .....	186
28.2.2 Port Settings .....	187
28.2.3 Port Edit .....	188
28.2.4 Local Information Settings .....	189
28.2.5 Local Information Edit .....	191
28.2.6 MED Network Policy .....	194
28.2.7 MED Network Policy Add or Edit .....	194
28.2.8 MED Port .....	196
28.2.9 MED Port Edit .....	196
<b>Chapter 29</b>	
<b>Configuration: QoS .....</b>	<b>198</b>
29.1 Overview .....	198
29.2 General Settings .....	198
29.2.1 Port Settings .....	198
29.2.2 Port Edit .....	199
29.2.3 Queue Settings .....	200
29.2.4 CoS Mapping .....	201
29.2.5 DSCP Mapping .....	202
29.2.6 IP Precedence Mapping .....	203
29.3 Trust Mode .....	204
29.3.1 Global Settings .....	204
29.3.2 Port Settings .....	204
29.3.3 Trust Mode Edit .....	205
<b>Chapter 30</b>	
<b>Configuration: Security .....</b>	<b>207</b>
30.1 Overview .....	207
30.2 Port Security .....	207
30.2.1 Global Settings .....	207
30.2.2 Port Settings .....	207
30.2.3 Port Edit .....	208
30.3 Port Isolation .....	209
30.3.1 Port Isolation Settings .....	209
30.3.2 Port Isolation Edit .....	210

30.4 802.1X Settings .....	210
30.4.1 Global Settings .....	210
30.4.2 Port Settings .....	211
30.4.3 Port Edit .....	212
30.5 DoS Settings .....	213
30.5.1 Global Settings .....	213
30.5.2 Port Settings .....	213
30.5.3 Port Edit .....	214
30.5.4 DoS Attack Types .....	215
<b>Chapter 31</b>	
<b>Configuration: AAA.....</b>	<b>216</b>
31.1 Overview .....	216
31.2 Auth Method .....	216
31.2.1 Auth Method Settings .....	216
31.2.2 Auth Method Add or Edit .....	216
31.3 RADIUS Settings .....	217
31.3.1 RADIUS .....	217
31.3.2 RADIUS Add or Edit .....	218
31.4 TACACS+ Settings .....	219
31.4.1 TACACS+ .....	219
31.4.2 TACACS+ Add or Edit .....	219
<b>Chapter 32</b>	
<b>Configuration: Management.....</b>	<b>221</b>
32.1 Overview .....	221
32.2 Syslog Settings .....	221
32.2.1 Global Settings .....	221
32.2.2 Local Settings .....	221
32.2.3 Local Add or Edit .....	222
32.2.4 Remote Settings .....	223
32.2.5 Remote Add or Edit .....	223
32.3 SNMP Settings .....	224
32.3.1 Global Settings .....	224
32.3.2 Community Settings .....	224
32.3.3 Community Add or Edit .....	225
32.3.4 Group Settings .....	225
32.3.5 Group Add or Edit .....	226
32.3.6 User Settings .....	227
32.3.7 User Add or Edit .....	228
32.3.8 Trap Settings .....	228
32.3.9 Trap Destination .....	229
32.3.10 Trap Destination Add or Edit .....	230

---

32.4 Error Disable .....	231
32.4.1 Error Disable Settings .....	231
32.5 HTTP/HTTPS .....	231
32.5.1 HTTP Settings .....	231
32.5.2 HTTPS Settings .....	232
32.6 TELNET/SSH .....	233
32.6.1 TELNET Settings .....	233
32.6.2 SSH Settings .....	233
32.7 Users Settings .....	234
32.7.1 Users .....	234
32.7.2 Users Add or Edit .....	234
32.8 Remote Access Control .....	235
32.8.1 Global Settings .....	235
32.8.2 Profile Add or Edit .....	236
<b>Chapter 33</b>	
<b>Maintenance.....</b>	<b>238</b>
33.1 Firmware Upgrade .....	238
33.1.1 Overview .....	238
33.1.2 Upgrade the firmware from a file on a server .....	238
33.1.3 Upgrade the firmware from a file on your computer .....	239
33.2 Firmware Management .....	239
33.2.1 Overview .....	239
33.2.2 Select the Active Image .....	240
33.3 Backup a Configuration File .....	241
33.3.1 Overview .....	241
33.3.2 Back up configuration or log files to a server .....	242
33.3.3 Back up configuration or log files to your computer .....	242
33.4 Restore a Configuration File .....	242
33.4.1 Overview .....	242
33.4.2 Restore the configuration from a file on a server .....	243
33.4.3 Restore the configuration from a file on your computer .....	243
33.5 Manage Configuration Files .....	243
33.5.1 Overview .....	243
33.6 Reset to Factory Defaults .....	244
33.6.1 Overview .....	244
33.6.2 Reset the Switch to Factory Defaults .....	244
33.7 Network Diagnostics .....	245
33.7.1 Port Test .....	245
33.7.2 IPv4 Ping Test .....	245
33.7.3 IPv6 Ping Test .....	247
33.7.4 Trace Route .....	248
33.8 Reboot .....	249

33.8.1 Overview .....	249
33.8.2 Reboot the Switch .....	249
<b>Chapter 34</b>	
<b>Troubleshooting.....</b>	<b>250</b>
34.1 Power, Hardware Connections, and LEDs .....	250
34.2 Switch Access and Login .....	251
34.3 Switch Configuration .....	252
Appendix A Customer Support .....	253
Appendix B Legal Information .....	258
<b>Index .....</b>	<b>265</b>

---

# PART I

## User's Guide

---



# CHAPTER 1

## Getting to Know Your Switch

This chapter introduces the main features and applications of the Switch.

### 1.1 Introduction

The GS1900 series is a new generation Gigabit Ethernet (GbE) Web-Managed Switch.

#### 1.1.1 Hardware Version Information

The GS1900 series have hardware revisions, and the major changes are:

- For the reset Switch back to factory default function, the **RESET** button is renamed to **RESTORE** to align with the rest of the Zyxel Switches
- For the GS1900-24 / GS1900-24EP / GS1900-24HP / GS1900-48 / GS1900-48HP models, the **RESET** button is added to support the reboot Switch function.

To find out the hardware version of your Switch, do the following:

- See the back label on the Switch

Figure 1 Example Back Label



Note: The **Rev.** information is not shown on the back label of the A1 hardware version of GS1900 Series models.

- On the Web Configurator, see the **Model Name** and **Revision** fields in the **Status** screen.

Figure 2 Example Status &gt; Device Information Screen: Model Name and Revision

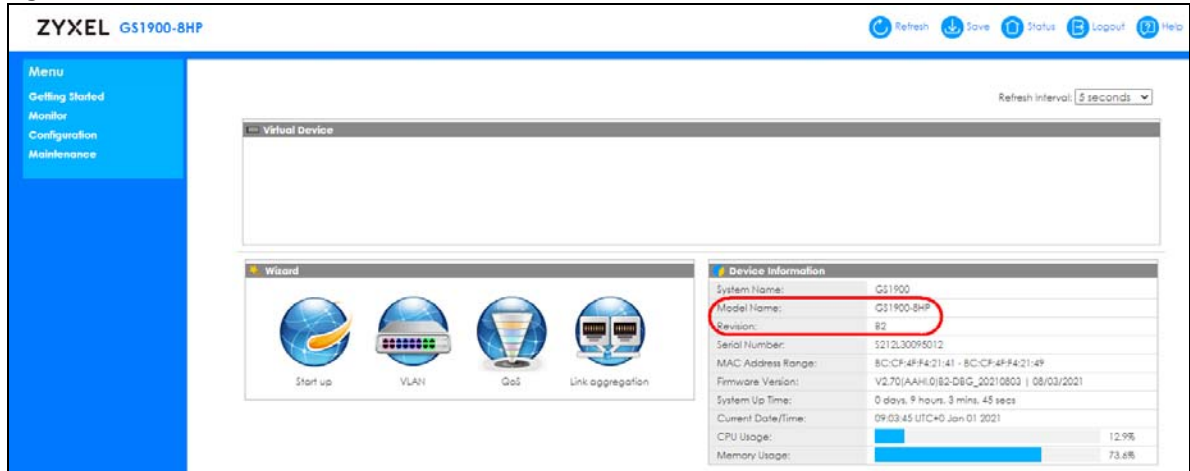

See the following table to use the back label or the Web Configurator to know the hardware version of your Switch.

Table 1 GS1900 Series Hardware Version Table

MODEL	BACK LABEL (Rev.)	WEB CONFIGURATOR (Model Name + Revision = HARDWARE VERSION)
GS1900-8	None	GS1900-8 A1
	B1	GS1900-8 B1
GS1900-8HP	None	GS1900-8HP A1
	B1	GS1900-8HP B1
	<b>B2</b>	<b>GS1900-8HP B2</b>
GS1900-10HP	None	GS1900-10HP A1
	B1	GS1900-10HP B1
GS1900-16	None	GS1900-16 A1
	B1	GS1900-16 B1
GS1900-24E	None	GS1900-24E A1
	B1	GS1900-24E B1
GS1900-24EP	None	GS1900-24EP A1
GS1900-24	None	GS1900-24 A1
	B1	GS1900-24 B1
GS1900-24HP	None	GS1900-24HP A1
GS1900-24HPv2	B1	GS1900-24HP B1
GS1900-48	None	GS1900-48 A1
	B1	GS1900-48 B1
GS1900-48HP	None	GS1900-48HP A1
GS1900-48HPv2	B1	GS1900-48HP B1

## 1.1.2 Hardware Comparison

This User's Guide covers the following models. See [Table 1 on page 18](#) for hardware version information.

Table 2 GS1900 Series Hardware Comparison Table 1

MODEL	GS1900-8		GS1900-8HP			GS1900-10HP		GS1900-16		
HARDWARE VERSION	A1	B1	A1	B1	B2	A1	B1	A1	B1	
100/1000 Mbps Port	8		No			No		16		
100/1000 Mbps PoE Port	No		8			8		No		
1G SFP Slots Fiber-optic	No		No			2		No		
Desktop	Yes		Yes			Yes		Yes		
Wall-mount	Yes		Yes			Yes		Yes		
Rack-mount	No		No			No		Yes		
Power ON/OFF Switch	Yes	No	Yes		No	Yes	No	No		
Reboot Function	No		No			No		No		
Reset to Factory Default Function	Yes*	Yes**	Yes*		Yes**	Yes*	Yes**	Yes*	Yes**	
Note: * Press the <b>RESET</b> button for more than 6 seconds. ** Press the <b>RESTORE</b> button for more than 6 seconds.										
PoE MODE Button	No		No			No		No		
Kensington Lock	No		No			No		No		
Power	DC Jack-type		DC Pin-type		DC Jack-type	DC Pin-type		DC Jack-type		AC Input

Table 3 GS1900 Series Hardware Comparison Table 2

MODEL	GS1900-24E		GS1900-24EP	GS1900-24		GS1900-24HP		GS1900-48		GS1900-48HP	
HARDWARE VERSION	A1	B1	A1	A1	B1	A1	B1	A1	B1	A1	B1
100/1000 Mbps Port	24		12	24		No		48		24	
100/1000 Mbps PoE Port	No		12	No		24		No		24	
1G SFP Slots Fiber-optic	No		No	2		2		2		2	
Desktop	Yes		No	No		No		No		No	
Wall-mount	Yes		No	No		No		No		No	
Rack-mount	Yes		Yes	Yes		Yes		Yes		Yes	
Power ON/OFF Switch	No		No	No		No		No		No	

Table 3 GS1900 Series Hardware Comparison Table 2 (continued)

MODEL	GS1900-24E		GS1900-24EP	GS1900-24		GS1900-24HP		GS1900-48		GS1900-48HP	
HARDWARE VERSION	A1	B1	A1	A1	B1	A1	B1	A1	B1	A1	B1
Reboot Function	No		Yes*	No	Yes*	No	Yes*	No	Yes*	No	Yes*
Note: * Press the <b>RESET</b> button.											
Reset to Factory Default Function	Yes*	Yes**	Yes**	Yes*	Yes**	Yes*	Yes**	Yes*	Yes**	Yes*	Yes**
Note: * Press the <b>RESET</b> button for more than 6 seconds. ** Press the <b>RESTORE</b> button for more than 6 seconds.											
PoE MODE Button	No		No	No		No		No		Yes	
Kensington Lock	No		Yes	No	Yes	No	Yes	No	Yes	No	Yes
Power	AC Input		AC Input	AC Input		AC Input		AC Input		AC Input	

## 1.2 Example Applications

This section shows a few examples of using the Switch in various network environments. Note that the Switch in the figure is just an example Switch and not your actual Switch.

### 1.2.1 PoE Example Application

The Switch can supply PoE (Power over Ethernet) to Powered Devices (PDs) such as an IP camera, a wireless router, an IP telephone and a general outdoor router that are not within reach of a power outlet.

Figure 3 PoE Example Application

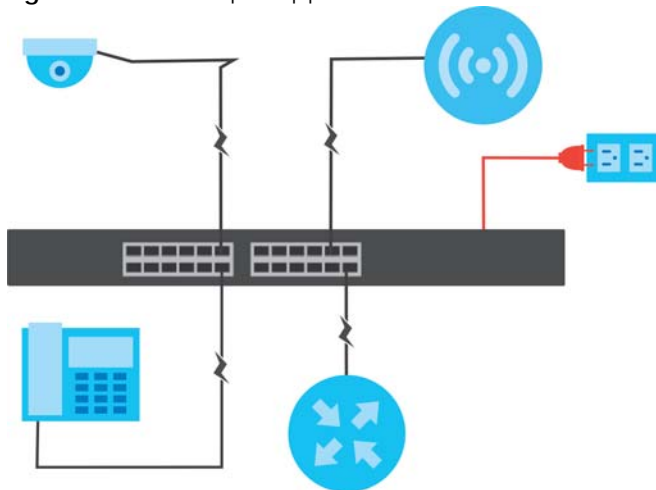

## 1.2.2 Backbone Example Application

The Switch is an ideal solution for small networks where rapid growth can be expected in the near future. The Switch can be used standalone for a group of heavy traffic users. You can connect computers and servers directly to the Switch's port or connect other switches to the Switch.

All computers can share high-speed applications on the server. To expand the network, simply add more networking devices such as switches, routers, computers, print servers, and so on.

**Figure 4** Backbone Example Application

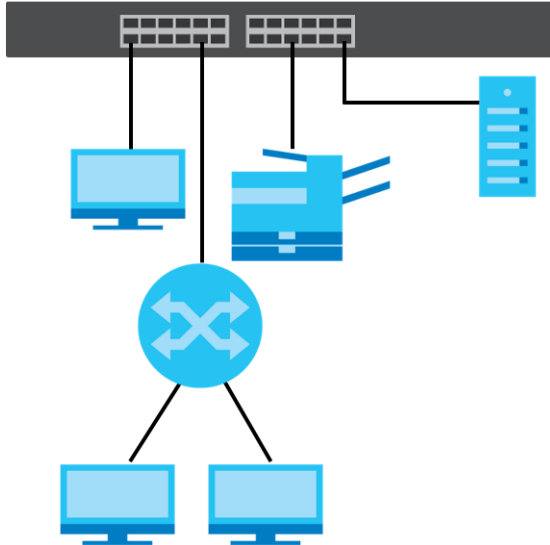

## 1.2.3 Bridging or Fiber-optic Uplink Example Application

The Switch connects different company departments (**RD** and **Sales**) to the corporate backbone. It can alleviate bandwidth contention and eliminate server and network bottlenecks. All users that need high bandwidth can connect to high-speed department servers through the Switch. You can provide a super-fast uplink connection by using a Gigabit Ethernet or SFP port on the Switch.

Figure 5 Bridging or Fiber-optic Uplink Example Application

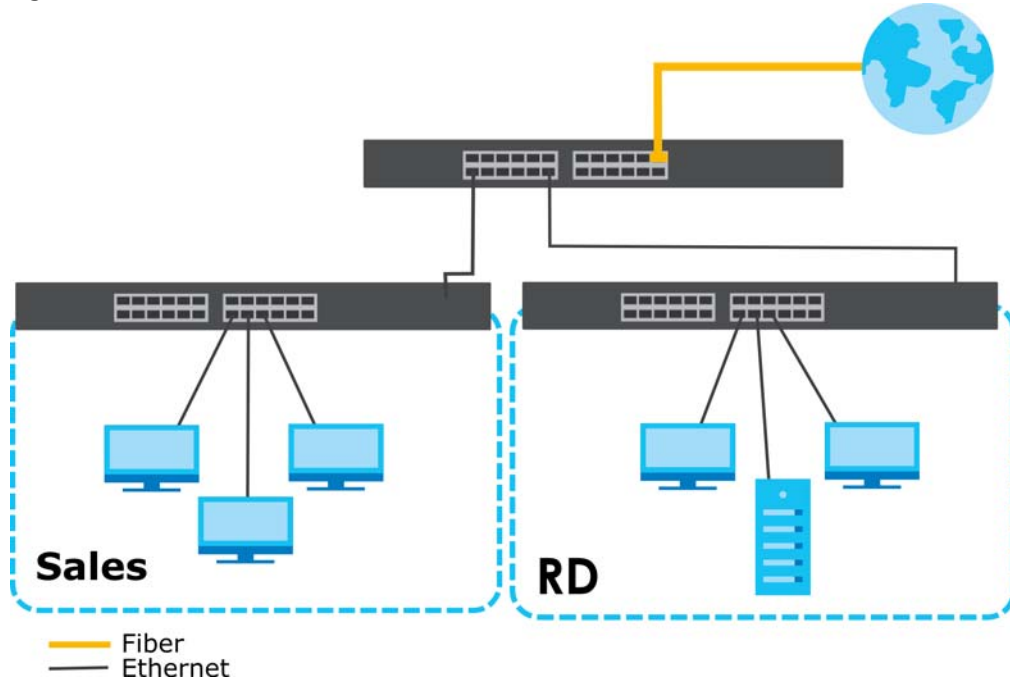

## 1.2.4 Gigabit Ethernet to the Desktop

The Switch is an ideal solution for small networks which demand high bandwidth for a group of heavy traffic users. You can connect computers and servers directly to the Switch's port or connect other switches to the Switch.

In this example, all computers can share high-speed applications on the server and access the Internet. To expand the network, simply add more networking devices such as switches, routers, computers, print servers and so on.

Figure 6 Gigabit to the Desktop

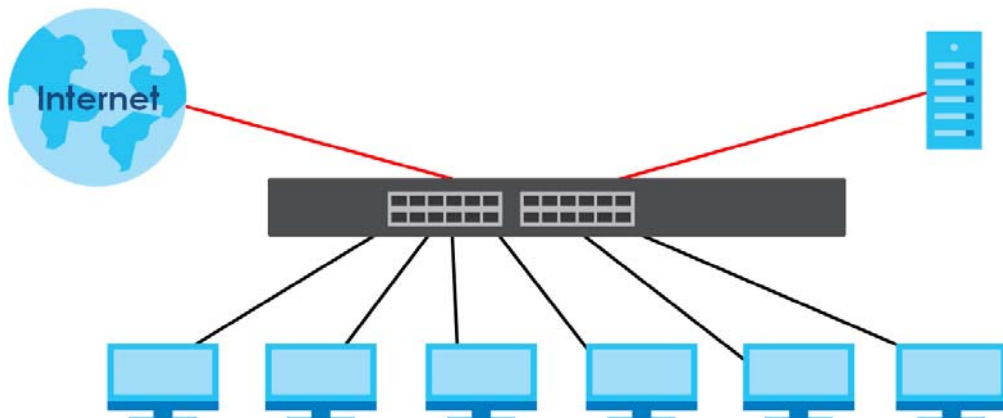

## 1.2.5 IEEE 802.1Q VLAN Application Example

A VLAN (Virtual Local Area Network) allows a physical network to be partitioned into multiple logical networks. Stations on a logical network belong to one or more groups. With VLAN, a station cannot

directly talk to or hear from stations that are not in the same groups unless such traffic first goes through a router.

For more information on VLANs, refer to [Chapter 9 on page 86](#).

### 1.2.5.1 Tag-based VLAN Example

Ports in the same VLAN group share the same frame broadcast domain, therefore increasing network performance by reducing broadcast traffic. VLAN groups can be modified at any time by adding, moving or changing ports without any re-cabling.

Shared resources such as a server can be used by all ports in the same VLAN as the server. In the following figure only ports that need access to the server need to be part of VLAN 1. Ports can belong to other VLAN groups too.

**Figure 7** Shared Server Using VLAN Example

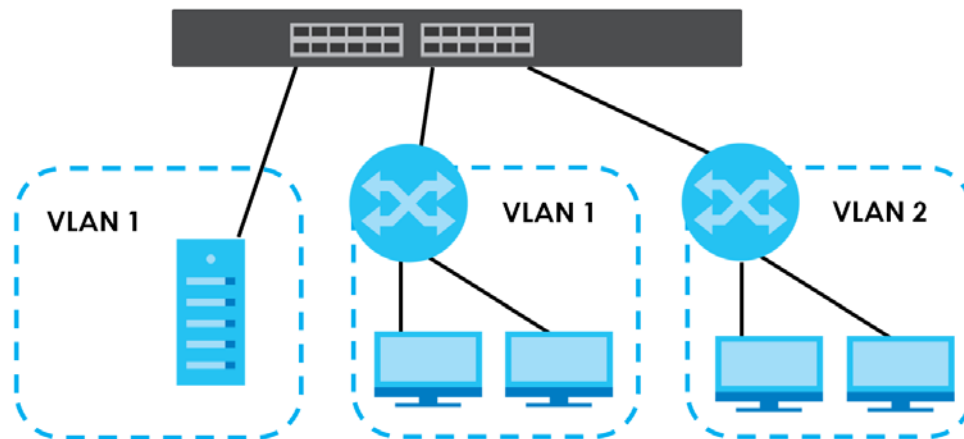

### 1.2.6 IPv6 Support

IPv6 (Internet Protocol version 6), is designed to enhance IP address size and features. The increase in IPv6 address size to 128 bits (from the 32-bit IPv4 address) allows up to  $3.4 \times 10^{38}$  IP addresses. At the time of writing, the Switch supports the following features.

- Static address assignment and stateless auto-configuration
- Neighbor Discovery Protocol (a protocol used to discover other IPv6 devices in a network)
- Remote Management using PING, telnet, SNMP, HTTP and TFTP services
- ICMPv6 to report errors encountered in packet processing and perform diagnostic functions, such as "PING"
- IPv4/IPv6 dual stack; the Switch can run IPv4 and IPv6 at the same time
- DHCPv6 client

## 1.3 Ways to Manage the Switch

Use any of the following methods to manage the Switch.

- Web Configurator. This is recommended for everyday management of the Switch using a (supported) web browser. See [Chapter 5 on page 50](#).
- TFTP. Use Trivial File Transfer Protocol for firmware upgrades and configuration backup or restore. See [Section 33.1 on page 238](#), [Section 33.3 on page 241](#), and [Section 33.4 on page 242](#).
- SNMP. The device can be configured by a SNMP manager. See [Section 32.3 on page 224](#).
- ZON Utility. ZON Utility is a program designed to help you deploy and perform initial setup on a network more efficiently. See [Section 4.1 on page 45](#).

## 1.4 Good Habits for Managing the Switch

Do the following things regularly to make the Switch more secure and to manage the Switch more effectively.

- Change the password. Use a password that is not easy to guess and that consists of different types of characters, such as numbers and letters.
- Write down the password and put it in a safe place.
- Back up the configuration (and make sure you know how to restore it). Restoring an earlier working configuration may be useful if the device becomes unstable or even crashes. If you forget your password, you will have to reset the Switch to its factory default settings. If you backed up an earlier configuration file, you would not have to totally re-configure the Switch. You could simply restore your last configuration.



# CHAPTER 2

# Hardware Installation and Connection

This chapter shows you how to install and connect the Switch.

## 2.1 Safety Precautions

Please observe the following before using the Switch:

- It is recommended to ask an authorized technician to attach the Switch on a desk or to the rack or wall. Use the proper screws to prevent damage to the Switch. See the **Installation Requirements** sections in this chapter to know the types of screws and screwdrivers for each mounting method.
- Make sure there is at least 2 cm of clearance on the top and bottom of the Switch, and at least 5 cm of clearance on all four sides of the Switch. This allows air circulation for cooling.
- Do NOT block the ventilation holes nor store cables or power cords on the Switch. Allow clearance for the ventilation holes to prevent your Switch from overheating. This is especially crucial when your Switch does not have fans. Overheating could affect the performance of your Switch, or even damage it.
- The surface of the Switch could be hot when it is functioning. Do NOT put your hands on it. You may get burned. This could happen especially when you are using a fanless Switch.
- The Switches with fans are not suitable for use in locations where children are likely to be present.

To start using the Switch, simply connect the power cables to turn it on.

## 2.2 Installation Scenarios

This chapter shows you how to install and connect the Switch.

The Switch can be:

- Placed on a desktop.
- Mounted on a wall.
- Rack-mounted on a standard EIA rack.

Note: Ask an authorized technician to attach the Switch to the rack or wall. See the **Installation Requirements** sections in this chapter to know the types of screws and screwdrivers for wall-mounting.

**WARNING! Failure to use the proper screws may damage the unit.**

**Make sure you connect the Switch's power cord to a socket-outlet with an earthing connection or its equivalent.**

**WARNING! This Switch is not suitable for use in locations where children are likely to be present.**

See [Table 2 on page 19](#) for the comparison table of the hardware installation methods for each model.

## 2.3 Desktop Installation Procedure

- 1 Make sure the Switch is clean and dry.
- 2 Set the Switch on a smooth, level surface strong enough to support the weight of the Switch and the connected cables. Make sure there is a power outlet nearby.
- 3 Make sure there is at least 40 mm of clearance from the bottom to the Switch, and make sure there is enough clearance around the Switch to allow air circulation and the attachment of cables and the power cord. This is especially important for enclosed rack installations.
- 4 Remove the adhesive backing from the rubber feet.
- 5 Attach the rubber feet to each corner on the bottom of the Switch. These rubber feet help protect the Switch from shock or vibration and ensure space between devices when stacking.

**Figure 8** Attaching Rubber Feet

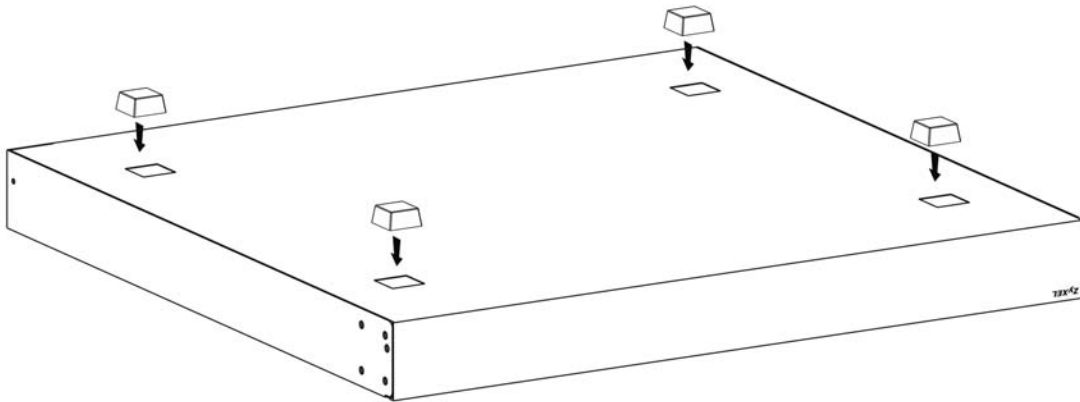

Note: Do NOT block the ventilation holes. Leave space between devices when stacking.

Note: For proper ventilation, allow at least 4 inches (10 cm) of clearance at the front and 3.4 inches (8 cm) at the back of the Switch. This is especially important for enclosed rack installations.

## 2.4 Wall Mounting

You may need screw anchors if mounting on a concrete or brick wall.

## 2.4.1 Wall-mounted Installation Requirement

The following are the wall-mounted installation requirements:

- Use screws with 6 mm – 8 mm (0.24" – 0.31") wide heads.
- See the following table for how far apart to place the screws.

Table 4 Distance between the centers of the holes for wall mounting

GS1900-8	GS1900-8HP	GS1900-10HP	GS1900-16	GS1900-24E
176 mm	176 mm	176 mm	148 mm	207 mm

The following figure shows the screw specifications used for wall mounting.

- D = 7.00 mm
- H = 2.00 mm
- L = 15.50 mm
- d = 3.50 mm

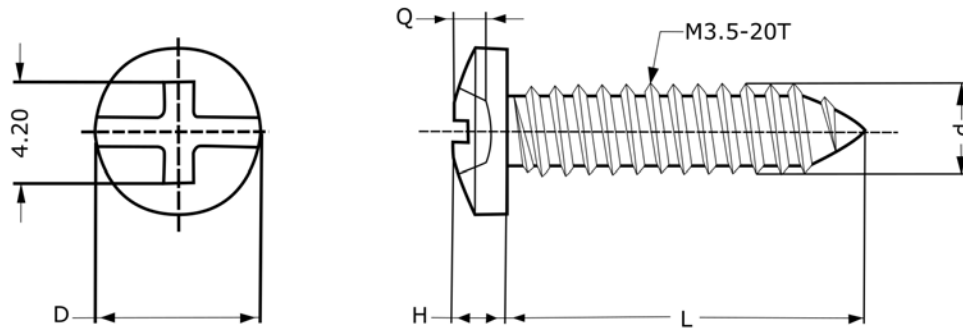

Do the following to attach your Switch to a wall.

- 1 Select a position free of obstructions on a wall strong enough to hold the weight of the Switch.
- 2 Mark two holes on the wall at the appropriate distance apart for the screws.

**WARNING! Be careful to avoid damaging pipes or cables located inside the wall when drilling holes for the screws.**

- 3 If using screw anchors, drill two holes for the screw anchors into the wall. Push the anchors into the full depth of the holes, then insert the screws into the anchors. Do NOT insert the screws all the way in – leave a small gap. The gap must be big enough for the screw heads to slide into the screw slots and the connection cables to run down the back of the Switch.

If not using screw anchors, use a screwdriver to insert the screws into the wall. Do NOT insert the screws all the way in – leave a gap.

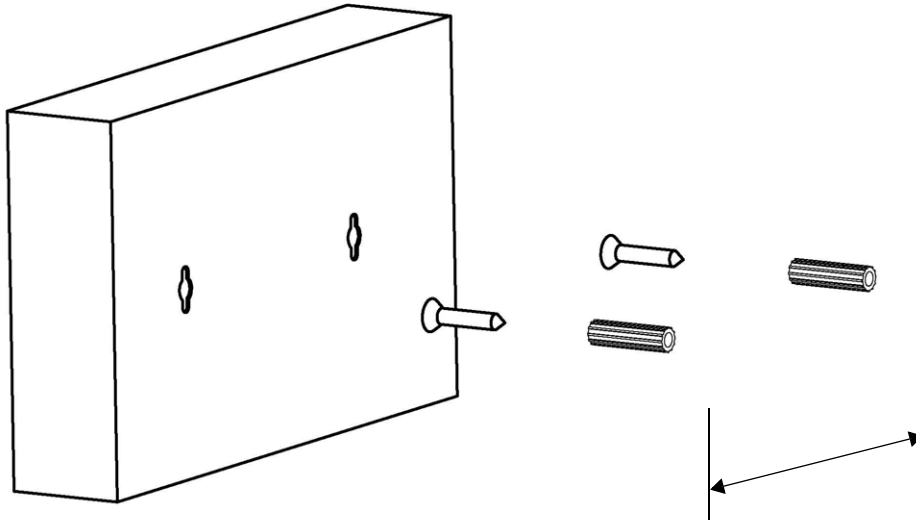

Note: Make sure the screws are fastened well enough to hold the weight of the Switch with the connection cables.

- 4 Align the holes on the back of the Switch with the screws on the wall. Hang the Switch on the screws.

Note: Make sure there is enough clearance between the wall and the Switch to allow ventilation.

**The Switch should be wall-mounted horizontally. The Switch's side panels with ventilation slots should not be facing up or down as this position is less safe.**

## 2.5 Rack Mounting

The Switch can be mounted on an EIA standard size, 19-inch rack or in a wiring closet with other equipment. Follow the steps below to mount your Switch on a standard EIA rack using a rack-mounting kit.

Note: Make sure there is enough clearance between each equipment on the rack for air circulation.

### 2.5.1 Rack-mounted Installation Requirement

The following are the rack-mounted installation requirements:

- Two mounting brackets.
- Eight M3 flat head screws and a #2 Philips screwdriver.
- Four M5 flat head screws and a #2 Philips screwdriver.

**Failure to use the proper screws may damage the unit.**

### 2.5.1.1 Precautions

- Make sure the rack will safely support the combined weight of all the equipment it contains.
- Make sure the position of the Switch does not make the rack unstable or top-heavy. Take all necessary precautions to anchor the rack securely before installing the unit.

## 2.5.2 Attaching the Mounting Brackets to the Switch

- 1 Position a mounting bracket on one side of the Switch, lining up the four screw holes on the bracket with the screw holes on the side of the Switch. See [Table 1 on page 18](#) for hardware version information.

**Figure 9** Attaching the Mounting Brackets (GS1900-16 A1/GS1900-16 B1, GS1900-24E A1/GS1900-24E B1, and GS1900-24EP A1)

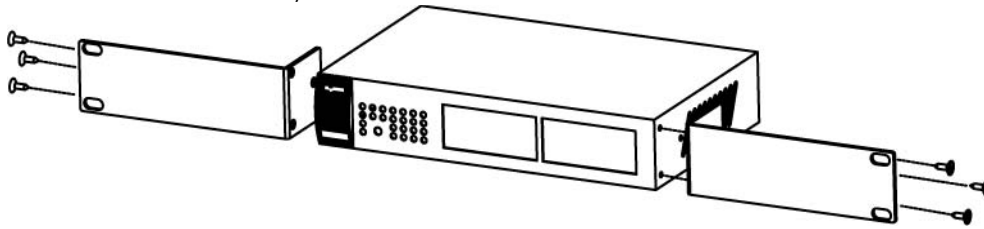

**Figure 10** Attaching the Mounting Brackets (GS1900-24 A1/GS1900-24 B1, GS1900-24HP A1/GS1900-24HP B1, GS1900-48 A1/GS1900-48 B1, and GS1900-48HP A1/GS1900-48HP B1)

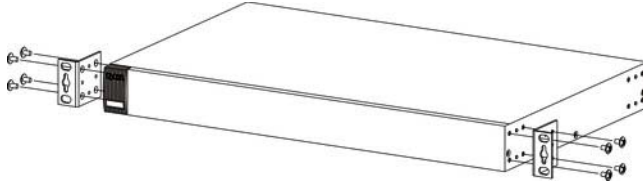

- 2 Using a #2 Philips screwdriver, install the M3 flat head screws through the mounting bracket holes into the Switch.
- 3 Repeat steps 1 and 2 to install the second mounting bracket on the other side of the Switch.
- 4 You may now mount the Switch on a rack. Proceed to the next section.

## 2.5.3 Mounting the Switch on a Rack

- 1 Position a mounting bracket (that is already attached to the Switch) on one side of the rack, lining up the two screw holes on the bracket with the screw holes on the side of the rack. See [Table 1 on page 18](#) for hardware version information.

**Figure 11** Mounting the Switch on a Rack (GS1900-16 A1/GS1900-16 B1, GS1900-24E A1/GS1900-24E B1, and GS1900-24EP A1)

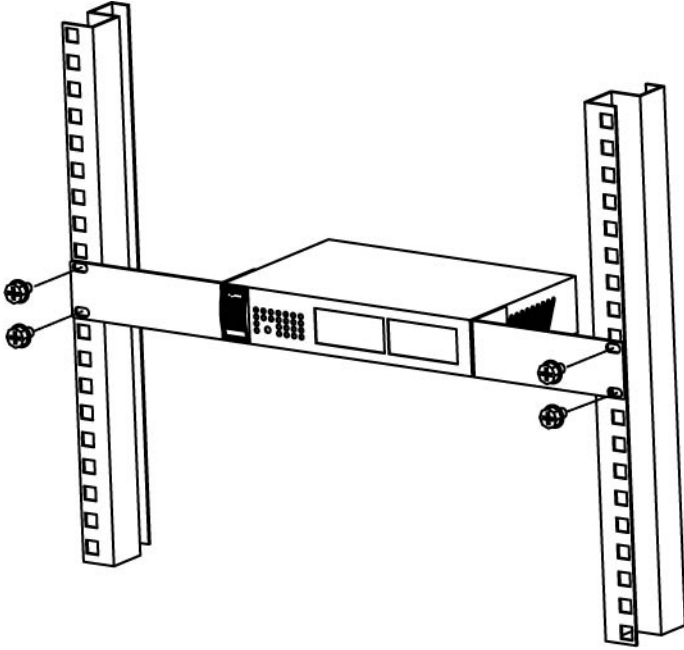

**Figure 12** Mounting the Switch on a Rack (GS1900-24 A1/GS1900-24 B1, GS1900-24HP A1/GS1900-24HP B1, GS1900-48 A1/GS1900-48 B1, and GS1900-48HP A1/GS1900-48HP B1)

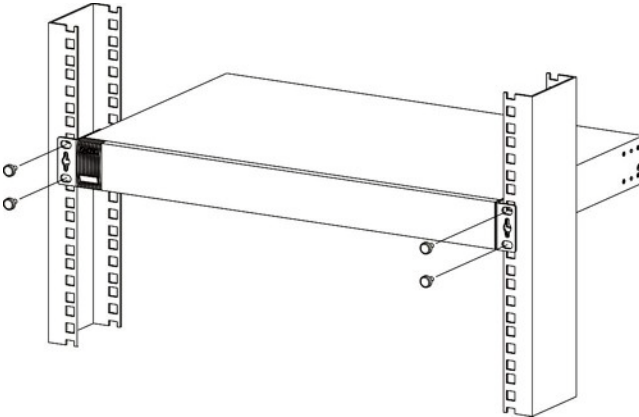

- 2 Using a #2 Philips screwdriver, install the M5 flat head screws through the mounting bracket holes into the rack.

Note: Make sure you tighten all the four screws to prevent the Switch from getting slanted.

- 3 Repeat steps 1 and 2 to attach the second mounting bracket on the other side of the rack.

# CHAPTER 3

## Hardware Overview

This chapter describes the front panel and rear panel of the Switch and shows you how to make the hardware connections.

### 3.1 Front Panel Connections

The following figures show the front panels of the Switch. See [Table 1 on page 18](#) for hardware version information.

**Figure 13** Front Panel: GS1900-8 A1



**Figure 14** Front Panel: GS1900-8 B1



**Figure 15** Front Panel: GS1900-8HP



**Figure 16** Front Panel: GS1900-8HP B2



**Figure 17** Front Panel: GS1900-10HP A1



Figure 18 Front Panel: GS1900-10HP B1



Figure 19 Front Panel: GS1900-16 A1

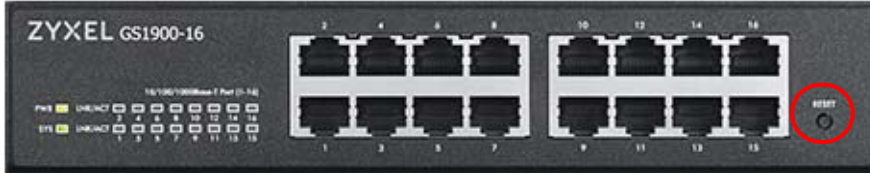

Figure 20 Front Panel: GS1900-16 B1

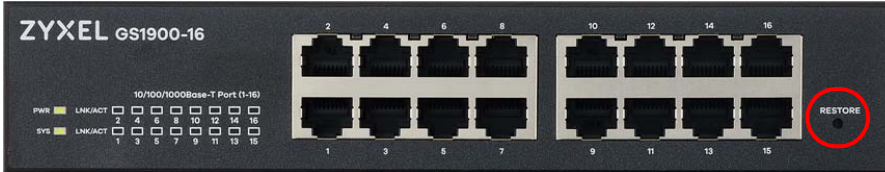

Figure 21 Front Panel: GS1900-24E A1

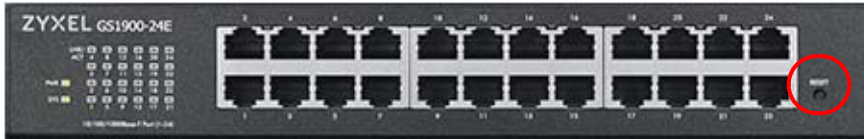

Figure 22 Front Panel: GS1900-24E B1

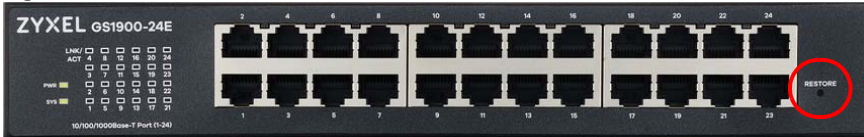

Figure 23 Front Panel: GS1900-24EP A1

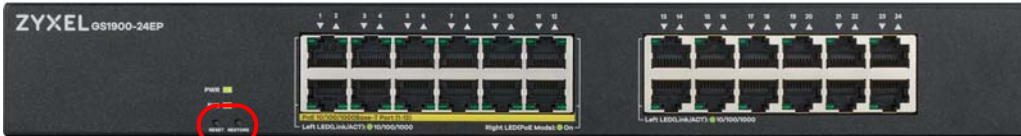

Figure 24 Front Panel: GS1900-24 A1



Figure 25 Front Panel: GS1900-24 B1



Figure 26 Front Panel: GS1900-24HP A1



Figure 27 Front Panel: GS1900-24HP B1





Figure 28 Front Panel: GS1900-48 A1

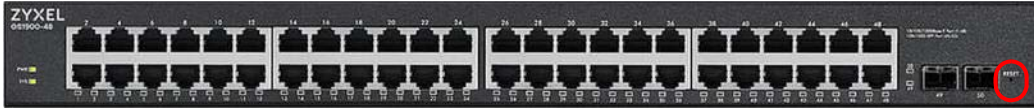

Figure 29 Front Panel: GS1900-48 B1



Figure 30 Front Panel: GS1900-48HP A1

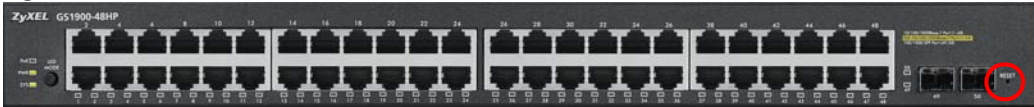

Figure 31 Front Panel: GS1900-48HP B1



### 3.1.1 Ethernet Ports

The Switch has 1000Base-T auto-negotiating, auto-crossover Ethernet ports. In 10/100/1000 Mbps Gigabit Ethernet, the speed can be 10Mbps, 100 Mbps or 1000 Mbps. The duplex mode can be both half or full duplex at 100 Mbps and full duplex only at 1000 Mbps.

An auto-negotiating port can detect and adjust to the optimum Ethernet speed (10/100/1000 Mbps) and duplex mode (full duplex or half duplex) of the connected device.

An auto-crossover (auto-MDI/MDI-X) port automatically works with a straight-through or crossover Ethernet cable.

#### 3.1.1.1 Default Ethernet Settings

The factory default negotiation settings for the Ethernet ports on the Switch are:

- Speed: Auto
- Duplex: Auto
- Flow control: Off

### 3.1.2 SFP Slots

These are slots for Small Form-Factor Pluggable (SFP) transceivers. A transceiver is a single unit that houses a transmitter and a receiver. Use a transceiver to connect a fiber-optic cable to the Switch. The Switch does not come with transceivers. You must use transceivers that comply with the Small Form-Factor Pluggable (SFP) Transceiver MultiSource Agreement (MSA). See the SFF committee's INF-8074i specification Rev 1.0 for details.

You can change transceivers while the Switch is operating. You can use different transceivers to connect to Ethernet switches with different types of fiber-optic connectors.

- Type: SFP connection interface

- Connection speed: 1 Gigabit per second (Gbps)

**WARNING!** To avoid possible eye injury, do not look into an operating fiber-optic module's connectors.

**HANDLING!** All transceivers are static sensitive. To prevent damage from electrostatic discharge (ESD), it is recommended you attach an ESD preventive wrist strap to your wrist and to a bare metal surface when you install or remove a transceiver.

**STORAGE!** All modules are dust sensitive. When not in use, always keep the dust plug on. Avoid getting dust and other contaminant into the optical bores, as the optics do not work correctly when obstructed with dust.

### 3.1.2.1 Transceiver Installation

Use the following steps to install a transceiver.

- 1 Attach an ESD preventive wrist strap to your wrist and to a bare metal surface.
- 2 Align the transceiver in front of the slot opening.
- 3 Make sure the latch is in the lock position (latch styles vary), then insert the transceiver into the slot with the exposed section of PCB board facing down.
- 4 Press the transceiver firmly until it clicks into place.
- 5 The Switch automatically detects the installed transceiver. Check the LEDs to verify that it is functioning properly.
- 6 Remove the dust plugs from the transceiver and cables (dust plug styles vary).
- 7 Identify the signal transmission direction of the fiber-optic cables and the transceiver. Insert the fiber-optic cable into the transceiver.

**Figure 32** Latch in the Lock Position

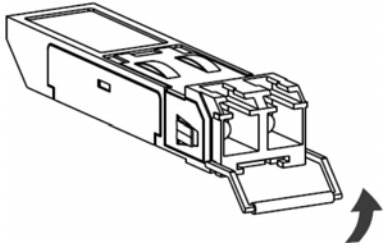

**Figure 33** Transceiver Installation Example

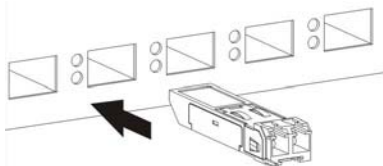

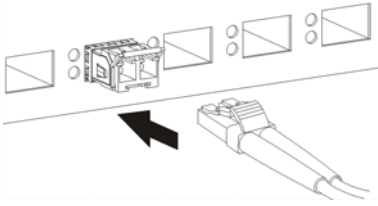
**Figure 34** Connecting the Fiber-optic Cables

### 3.1.2.2 Transceiver Removal

Use the following steps to remove an SFP transceiver.

- 1 Attach an ESD preventive wrist strap to your wrist and to a bare metal surface on the chassis.
- 2 Remove the fiber-optic cables from the transceiver.
- 3 Pull out the latch and down to unlock the transceiver (latch styles vary).

Note: Make sure the transceiver's latch is pushed all the way down, so the transceiver can be pulled out successfully.

- 4 Pull the latch, or use your thumb and index finger to grasp the tabs on both sides of the transceiver, and carefully slide it out of the slot.

Note: Do NOT pull the transceiver out by force. You could damage it. If the transceiver will not slide out, grasp the tabs on both sides of the transceiver with a slight up or down motion and carefully slide it out of the slot. If unsuccessful, contact Zyxel Support to prevent damage to your Switch and transceiver.

- 5 Insert the dust plug into the ports on the transceiver and the cables.

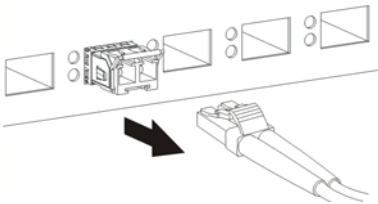
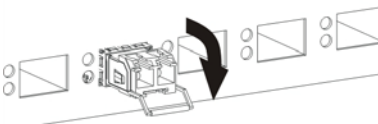
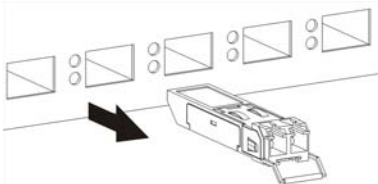
**Figure 35** Removing the Fiber-optic Cables**Figure 36** Opening the Transceiver's Latch Example**Figure 37** Transceiver Removal Example

### 3.1.3 PoE Mode Button

Push or release the **PoE MODE** button to change how the Ethernet port's **Link/ACT** LED works.

- Each Ethernet port's LED is changed to act as a **PoE MODE** LED by pushing the **PoE MODE** button on the front panel. The **PoE** LED lights green when PoE mode is enabled.
- Each Ethernet port's LED is changed back to act as a **Link/ACT** LED by releasing the **PoE MODE** button on the front panel. The **PoE** LED is off when PoE mode is disabled.

**Figure 38** PoE LED and PoE MODE Button: GS1900-48HP A1

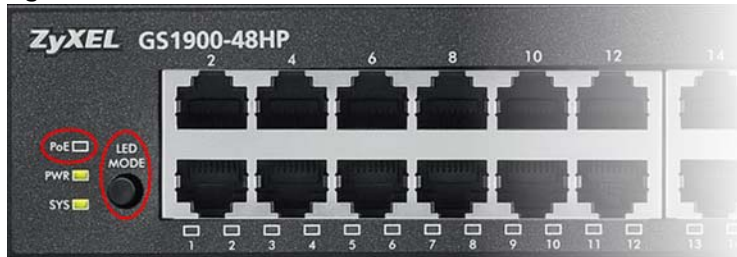

**Figure 39** PoE LED and PoE MODE Button: GS1900-48HP B1

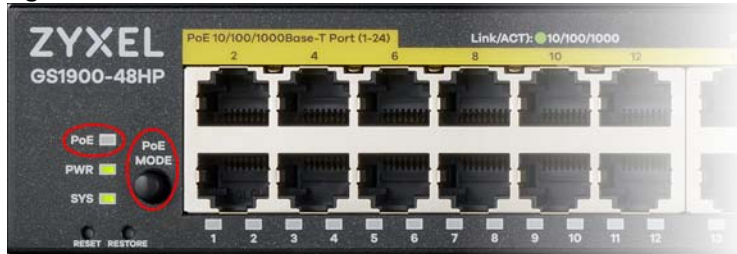

View the GS1900-48HP A1 / GS1900-48HP B1 LEDs to ensure proper functioning of the Switch and as an aid in troubleshooting (see [Table 8 on page 42](#)). See [Table 1 on page 18](#) for hardware version information.

## 3.2 Rear Panel

The following figures show the rear panels of the Switch. See [Table 1 on page 18](#) for hardware version information.

**Figure 40** Rear Panel: GS1900-8 A1



**Figure 41** Rear Panel: GS1900-8 B1



**Figure 42** Rear Panel: GS1900-8HP

A1



B1



**Figure 43** Rear Panel: GS1900-8HP B2



**Figure 44** Rear Panel: GS1900-10HP A1



**Figure 45** Rear Panel: GS1900-10HP B1



**Figure 46** Rear Panel: GS1900-16 A1



**Figure 47** Rear Panel: GS1900-16 B1

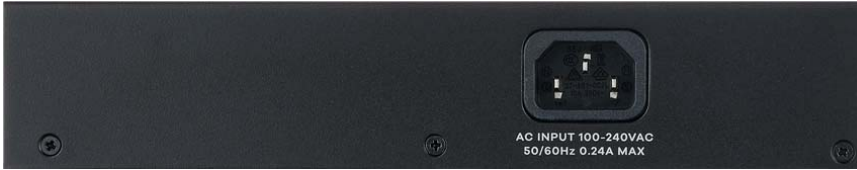
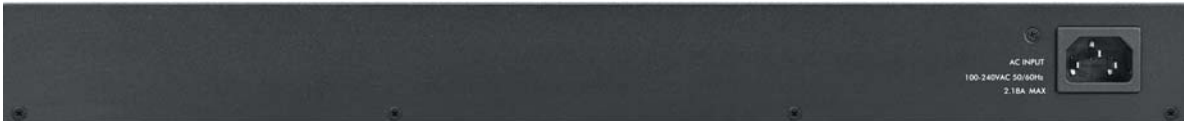

**Figure 48** Rear Panel: GS1900-24E A1



**Figure 49** Rear Panel: GS1900-24E B1



**Figure 50** Rear Panel: GS1900-24EP A1**Figure 51** Rear Panel: GS1900-24 A1**Figure 52** Rear Panel: GS1900-24 B1**Figure 53** Rear Panel: GS1900-24HP A1**Figure 54** Rear Panel: GS1900-24HP B1**Figure 55** Rear Panel: GS1900-48 A1**Figure 56** Rear Panel: GS1900-48 B1**Figure 57** Rear Panel: GS1900-48HP A1**Figure 58** Rear Panel: GS1900-48HP B1

### 3.2.1 Grounding

Grounding is a safety measure to direct excess electric charge to the ground. It prevents damage to the Switch, and protects you from electrocution. Use the grounding screw on the rear panel and the ground wire of the AC power supply to ground the Switch.

The grounding terminal and AC power ground where you install the Switch must follow your country's regulations. Qualified service personnel must ensure the building's protective earthing terminals are valid terminals.

Installation of Ethernet cables must be separate from AC power lines. To avoid electric surge and electromagnetic interference, use a different electrical conduit or raceway (tube/trough or enclosed conduit for protecting electric wiring) that is 15 cm apart, or as specified by your country's electrical regulations.

Any device that is located outdoors and connected to this product must be properly grounded and surge protected. To the extent permissible by your country's applicable law, failure to follow these guidelines could result in damage to your Switch which may not be covered by its warranty.

Note: The specification for surge or ESD protection assumes that the Switch is properly grounded.

- 1 Remove the M4 ground screw from the Switch's rear panel.
- 2 Secure a green or yellow ground cable (16 AWG or smaller) to the Switch's rear panel using the M4 ground screw.

**Figure 59** Grounding

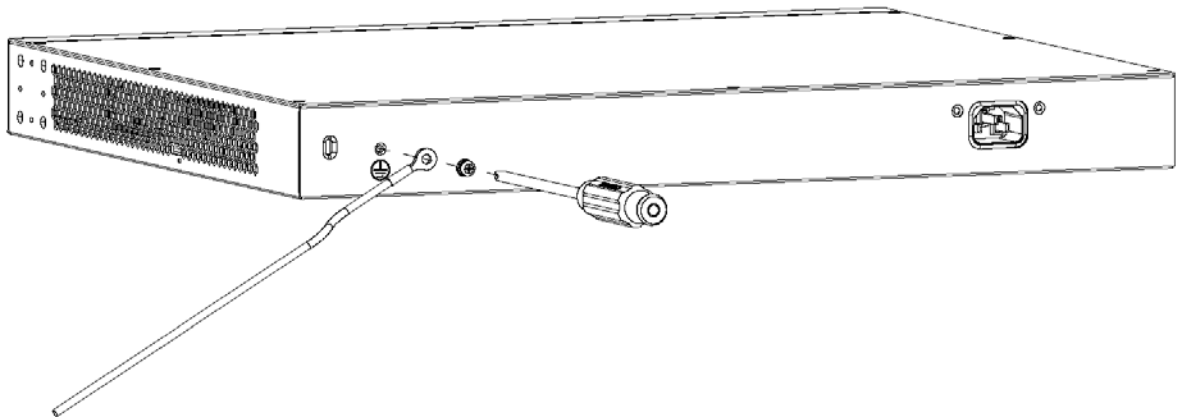

- 3 Attach the other end of the ground cable to a grounding bar located on the rack where you install the Switch or to an on-site grounding terminal.

**Figure 60** Attach Ground Cable to Grounding Bar or On-site Grounding Terminal

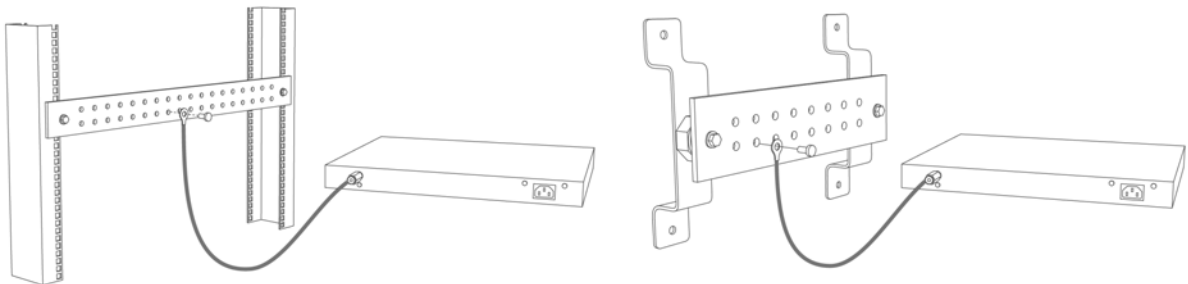

- 4 The grounding terminal of the server rack or on-site grounding terminal must also be grounded and connected to the building's main grounding electrode. Make sure the grounding terminal is connected to the buildings grounding electrode and has an earth resistance of less than 10 ohms, or according to your country's electrical regulations.

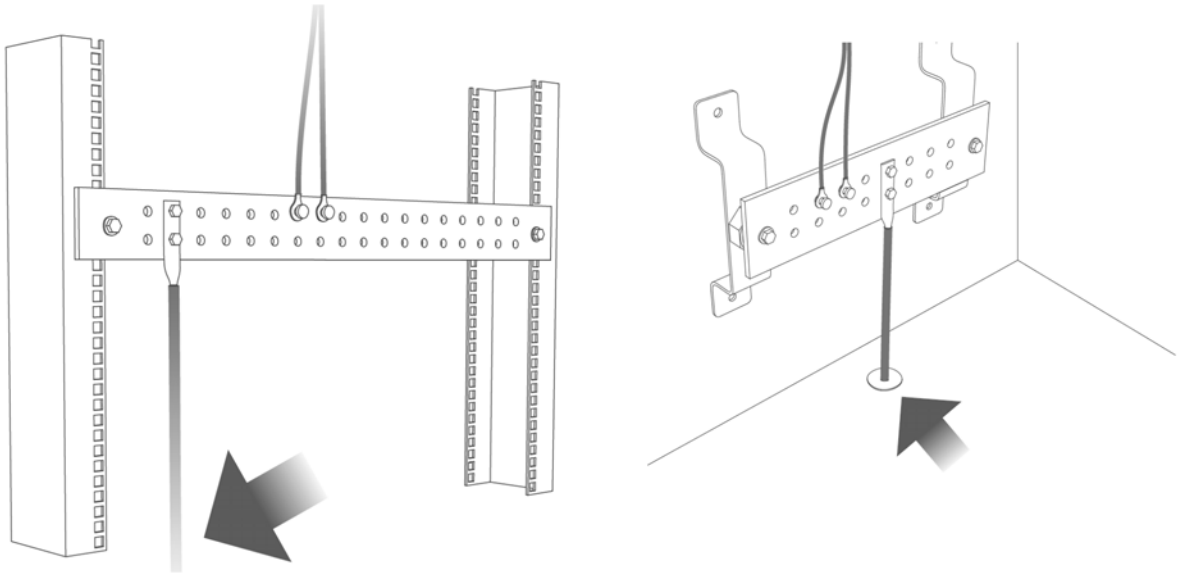
**Figure 61** Connecting to the Building's Main Grounding Electrode

If you are uncertain that suitable grounding is available, contact the appropriate electrical inspection authority or an electrician.

**This device must be grounded. Do this before you make other connections.**

### 3.2.2 Power Connection

Make sure you are using the correct power source and that no objects obstruct the airflow of the fans.

The Switch uses two power supply modules, one of which is redundant, so if one power module fails the system can operate on the remaining module.

#### Rear Panel Power Connection

Connect one end of the supplied power cord or power adapter to the power receptacle on the back of the Switch and the other end to the appropriate power source.

For Switches with a power switch (see [Table 2 on page 19](#)), use the **POWER ON/OFF** switch to have the Switch power on or off.

#### Connecting the Power

Use the following procedures to connect the Switch to a power source after you have installed it in a rack.

Note: Use the included power cord for the AC power connection.

- 1 Connect the female end of the power cord to the AC power socket.
- 2 Connect the other end of the cord to a power outlet.



## Disconnecting the Power

The power input connectors can be disconnected from the power source individually.

- 1 Disconnect the power cord from the power outlet.
- 2 Disconnect the power cord from the AC power socket.

## 3.3 LEDs

After you connect the power to the Switch, view the LEDs to ensure proper functioning of the Switch and as an aid in troubleshooting. See [Table 1 on page 18](#) for hardware version information.

Table 5 LED Descriptions

LED	COLOR	STATUS	DESCRIPTION
PWR	Green	On	The system is turned on.
		Off	The system is off or has failed.
SYS	Green	On	The system is on and functioning properly.
		Blinking	The system is rebooting and performing self-diagnostic tests.
		Off	The power is off or the system is not ready or malfunctioning.
Ethernet Ports			
LNK/ACT	Green	Blinking	The system is transmitting/receiving to/from a 100/1000 Mbps Ethernet network.
		On	The link to a 100/1000 Mbps Ethernet network is up.
		Off	The link to an Ethernet network is down.
PoE (see <a href="#">Section 3.1.3 on page 36</a> )	Green	On	Power is supplied to all PoE Ethernet ports.
		Off	There is no power supplied.
1G SFP Slots (Fiber-optic Ports – see <a href="#">Section 1.1 on page 17</a> )			
LNK/ACT	Green	Blinking	The system is transmitting/receiving to/from a 100/1000 Mbps fiber-optic network.
		On	The link to a 100/1000 Mbps fiber-optic network is up.
		Off	The link to a fiber-optic network is down.

Table 6 LED Descriptions (GS1900-8HP B1 and GS1900-10HP A1/GS1900-10HP B1 Only)

LED	COLOR	STATUS	DESCRIPTION
PWR	Green	On	The system is turned on.
		Off	The system is off or has failed.
SYS	Green	On	The system is on and functioning properly.
		Blinking	The system is rebooting.
	Red	On	There is a system error.

Table 6 LED Descriptions (GS1900-8HP B1 and GS1900-10HP A1/GS1900-10HP B1 Only) (continued)

LED	COLOR	STATUS	DESCRIPTION
PoE 10/100/1000Base-T Ports (1 – 8), 2 LEDs per port			
Right	Amber	On	The port is in PoE AF mode. That is, the Switch is following the IEEE 802.3af standard to supply power to this port.
	Green	On	The port is in PoE AT mode. That is, the Switch is following the IEEE 802.3at standard to supply power to this port.
		Off	Power is not supplied to this port.
Left	Amber	On	The link to a 10/100 Mbps Ethernet network is up.
		Blinking	The system is transmitting/receiving to/from a 10/100 Mbps fiber-optic network.
	Green	On	The link to a 1 Gbps Ethernet network is up.
		Blinking	The system is transmitting/receiving to/from 1 Gbps Ethernet network.

Table 7 LED Descriptions for SFP Port (GS1900-10HP A1/GS1900-10HP B1 Only)

LED	COLOR	STATUS	DESCRIPTION
Two arrow LEDs for 1G SFP Slots (Fiber-optic Ports)			
right/left arrows	Amber	On	The link to a 100 Mbps fiber-optic network is up.
		Blinking	The system is transmitting/receiving to/from a 100 Mbps fiber-optic network.
	Green	On	The link to a 1 Gbps fiber-optic network is up.
		Blinking	The system is transmitting/receiving to/from 1 Gbps fiber-optic network.

Table 8 LED Descriptions (GS1900-48HP A1/GS1900-48HP B1 Only)

LED	COLOR	STATUS	DESCRIPTION
Ethernet Ports when <b>PoE MODE</b> button is OFF			
PoE (see <a href="#">Section 3.1.3 on page 36</a> )		Off	Each Ethernet port's LED acts as a <b>Link/ACT</b> LED.

Table 8 LED Descriptions (GS1900-48HP A1/GS1900-48HP B1 Only) (continued)

LED	COLOR	STATUS	DESCRIPTION
LNK/ACT	Green	Blinking	The system is transmitting/receiving to/from a 100/1000 Mbps Ethernet network.
		On	The link to a 100/1000 Mbps Ethernet network is up.
		Off	The link to an Ethernet network is down.
Ethernet Ports when <b>PoE MODE</b> button is ON			
PoE	Green	On	Each Ethernet port's LED acts as a <b>PoE MODE</b> LED.
PoE Mode	Amber	On	The port is in PoE AF mode. That is, the Switch is following the IEEE 802.3af standard to supply power to this port.
	Green	On	The port is in PoE AT mode. That is, the Switch is following the IEEE 802.3at standard to supply power to this port.
		Off	Power is not supplied to this port.
1G SFP Slots (Fiber-optic Ports – see <a href="#">Section 1.1 on page 17</a> )			
LNK/ACT	Green	Blinking	The system is transmitting/receiving to/from a 100/1000 Mbps fiber-optic network.
		On	The link to a 100/1000 Mbps fiber-optic network is up.
		Off	The link to a fiber-optic network is down.

## 3.4 Resetting the Switch

If you lock yourself (and others) from the Switch, or you forget your password, or cannot access the Web Configurator, you will need to reload the factory-default configuration file.

- For the A1 hardware version, use the **RESET** button.
- For the B1 and later hardware version, use the **RESTORE** button.

To check which hardware version you are using, refer to [Section 1.1.1 on page 17](#).

This means that you will lose all configurations that you had previously and the default Switch IP address, user name and password will be reset to 192.168.1.1, admin and 1234 respectively.

Follow the steps below to reset the Switch back to factory defaults.

- 1 Make sure the **SYS** LED is steady green (not blinking). Use a pointed instrument such as a pin to access the **RESET/RESTORE** buttons on the front of the Switch as shown in [Section 3.1 on page 31](#).
- 2 Press the button for more than 6 seconds. After releasing the button, the **SYS** LED begins to blink. Wait for the Switch to restart (the **SYS** LED will be steady green again). This takes up to 2 minutes. See [Section 3.3 on page 41](#) for more information about the LED behavior.

Note: If you want to access the Switch Web Configurator again, you may need to change the IP address of your computer to be in the same subnet as that of the default Switch IP address (192.168.1.1).

## 3.5 Rebooting the Switch

Use any of the following methods to reboot the Switch without turning the power off.

- **RESET** button. Refer to [Table 2 on page 19](#) and [Table 3 on page 19](#) to see the list of models that support the **RESET** button to reboot the Switch. See [Section 3.3 on page 41](#) for more information about the LED behavior.
- Web Configurator. Click the **Reboot** button in the **Maintenance > Reboot** screen. See [Section 33.8 on page 249](#) for more information.
- ZON Utility. Click the **Reboot Device** button in the ZON Utility screen. See [Section 4.1.2 on page 46](#) for more information.

# CHAPTER 4

## ZON Utility

This chapter describes the screens for ZON Utility.

### 4.1 Zyxel One Network (ZON) Utility

ZON Utility is a program designed to help you deploy and manage a network more efficiently. It detects devices automatically and allows you to do basic settings on devices in the network without having to be near it.

The ZON Utility issues requests through Zyxel Discovery Protocol (ZDP) and in response to the query, the device responds back with basic information including IP address, firmware version, location, system and model name in the same broadcast domain. The information is then displayed in the ZON Utility screen and you can perform tasks like basic configuration of the devices and batch firmware upgrade in it. You can download the ZON Utility at [www.zyxel.com](http://www.zyxel.com) and install it in a computer (Windows operating system).

#### 4.1.1 Requirements

Before installing the ZON Utility on your computer, please make sure it meets the requirements listed below.

##### Operating System

At the time of writing, the ZON Utility is compatible with:

- Windows 7 (both 32-bit / 64-bit versions)
- Windows 8 (both 32-bit / 64-bit versions)
- Windows 8.1 (both 32-bit / 64-bit versions)
- Windows 10 (both 32-bit / 64-bit versions)

Note: To check for your Windows operating system version, right-click on **My Computer** > **Properties**. You should see this information in the **General** tab.

##### Hardware

Here are the minimum hardware requirements to use the ZON Utility on your PC.

- Core i3 processor
- 2 GB RAM

- 100 MB free hard disk
- WXGA (Wide XGA 1280 by 800)

## 4.1.2 Run the ZON Utility

- 1 Double-click the ZON Utility to run it.
- 2 The first time you run the ZON Utility, you will see if your device and firmware version support the ZON Utility. Click the **OK** button to close this screen.

**Figure 62** Supported Devices and Versions

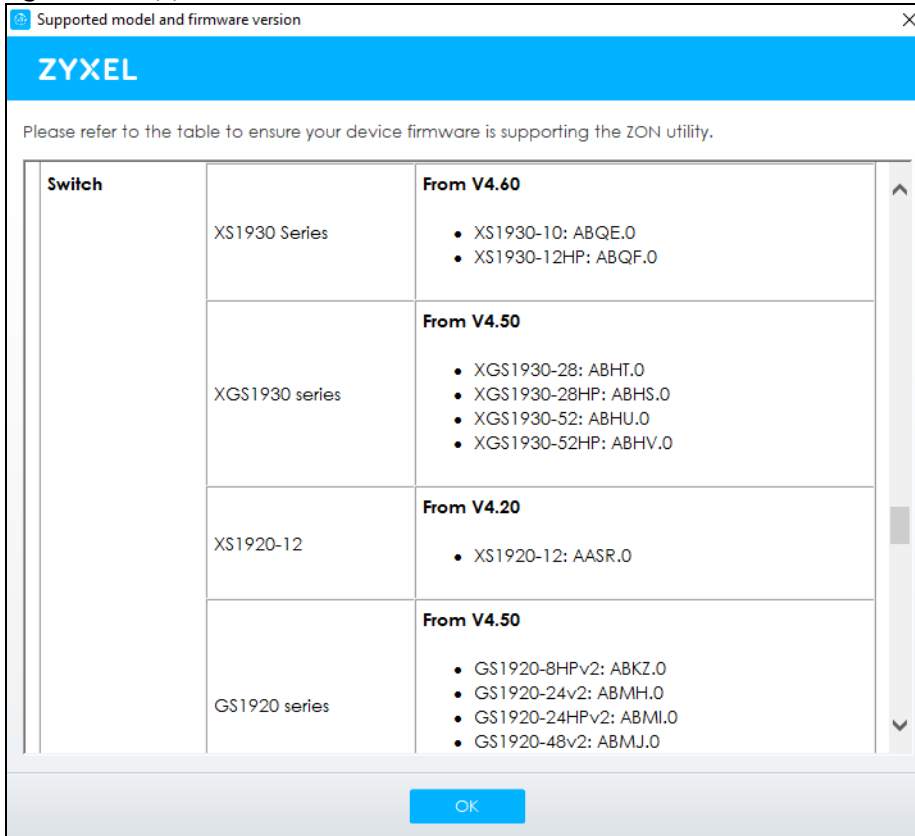

If you want to check the supported models and firmware versions later, you can click the **Show information about ZON** icon in the upper right hand corner of the screen. Then select the **Supported model and firmware version** link. If your device is not listed here, see the device release notes for ZON utility support. The release notes are in the firmware zip file on the Zyxel web site.

Figure 63 ZON Utility Screen

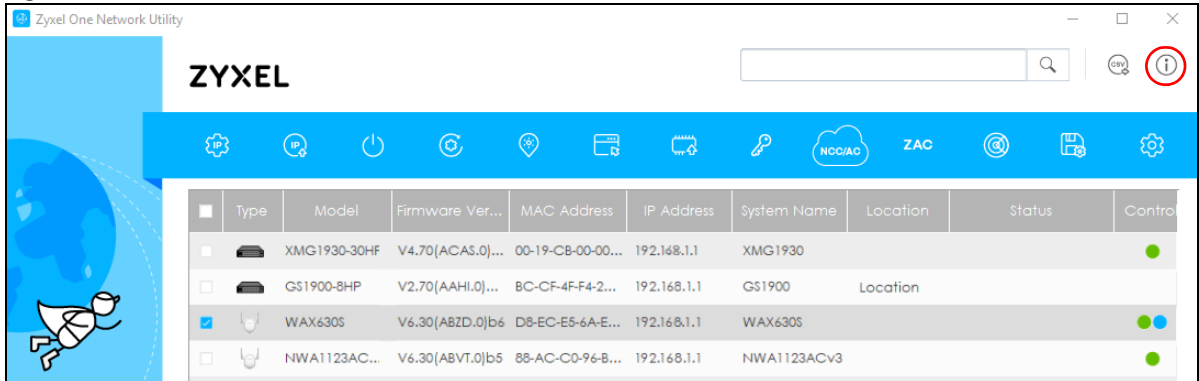

- 3 Select a network adapter to which your supported devices are connected.

Figure 64 Network Adapter



- 4 Click the **Go** button for the ZON Utility to discover all supported devices in your network.

Figure 65 Discovery

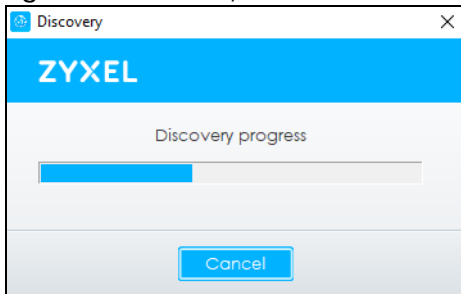

- 5 The ZON Utility screen shows the devices discovered.

Figure 66 ZON Utility Screen

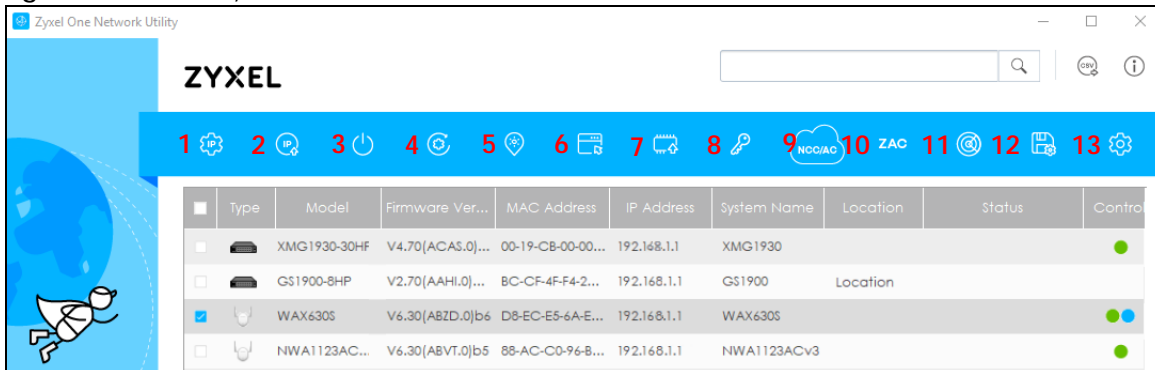

- 6 Select a device and then use the icons to perform actions. Some functions may not be available for your devices.

Note: You must know the selected device admin password before taking actions on the device using the ZON Utility icons.

Figure 67 Password Prompt

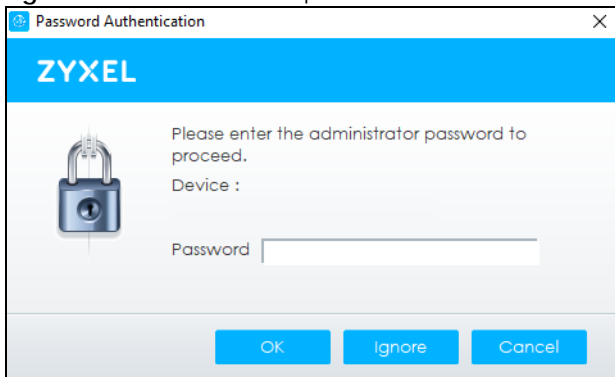

The following table describes the icons numbered from left to right in the ZON Utility screen.

Table 9 ZON Utility Icons

ICON	DESCRIPTION
1 IP configuration	Change the selected device's IP address.
2 Renew IP Address	Update a DHCP-assigned dynamic IP address.
3 Reboot Device	Use this icon to restart the selected devices. This may be useful when troubleshooting or upgrading new firmware.
4 Reset Configuration to Default	If you forget your password or cannot access the Web Configurator, you can use this icon to reload the factory-default configuration file. This means that you will lose all configurations that you had previously.
5 Locator LED	Use this icon to locate the selected device by causing its Locator LED to blink.
6 Web GUI	Use this to access the selected device web configurator from your browser. You will need a user name and password to log in.
7 Firmware Upgrade	Use this icon to upgrade new firmware to selected devices of the same model. Make sure you have downloaded the firmware from the Zyxel website to your computer and unzipped it in advance.
8 Change Password	Use this icon to change the admin password of the selected device. You must know the current admin password before changing to a new one.



Table 9 ZON Utility Icons (continued)

ICON	DESCRIPTION
9 Configure NCC Discovery	You must have Internet access to use this feature. Use this icon to enable or disable the Nebula Control Center (NCC) discovery feature on the selected device. If it is enabled, the selected device will try to connect to the NCC. Once the selected device is connected to and has registered in the NCC, it will go into the Nebula cloud management mode.
10 ZAC	Use this icon to run the Zyxel AP Configurator of the selected AP.
11 Clear and Rescan	Use this icon to clear the list and discover all devices on the connected network again.
12 Save Configuration	Use this icon to save configuration changes to permanent memory on a selected device.
13 Settings	Use this icon to select a network adapter for the computer on which the ZON utility is installed, and the utility language.

The following table describes the fields in the ZON Utility main screen.

Table 10 ZON Utility Fields

LABEL	DESCRIPTION
Type	This field displays an icon of the kind of device discovered.
Model	This field displays the model name of the discovered device.
Firmware Version	This field displays the firmware version of the discovered device.
MAC Address	This field displays the MAC address of the discovered device.
IP Address	This field displays the IP address of an internal interface on the discovered device that first received an ZDP discovery request from the ZON Utility.
System Name	This field displays the system name of the discovered device.
Location	This field displays where the discovered device is.
Status	This field displays whether changes to the discovered device have been done successfully. As the Switch does not support <b>IP Configuration</b> , <b>Renew IP address</b> and <b>Flash Locator LED</b> , this field displays "Update failed", "Not support Renew IP address" and "Not support Flash Locator LED" respectively.
NCC Discovery	This field displays if the discovered device supports the Nebula Control Center (NCC) discovery feature. If it is enabled, the selected device will try to connect to the NCC. Once the selected device is connected to and has registered in the NCC, it will go into the Nebula cloud management mode.
Serial Number	Enter the admin password of the discovered device to display its serial number.
Hardware Version	This field displays the hardware version of the discovered device.

# CHAPTER 5

## Web Configurator

### 5.1 Overview

This section introduces the configuration and functions of the Web Configurator.

The Web Configurator is an HTML-based management interface that allows easy Switch setup and management through Internet browser. Use a browser that supports HTML5, such as Microsoft Edge, Internet Explorer 11, Mozilla Firefox, or Google Chrome. The recommended minimum screen resolution is 1024 by 768 pixels.

In order to use the Web Configurator, you need to allow:

- Web browser pop-up windows
- JavaScript (enabled by default)
- Java permissions (enabled by default)

### 5.2 Access

- 1 Make sure your Switch hardware is properly connected. See the Quick Start Guide.
- 2 Browse to <https://192.168.1.1>. The **Login** screen appears.

**Figure 68** Login Screen

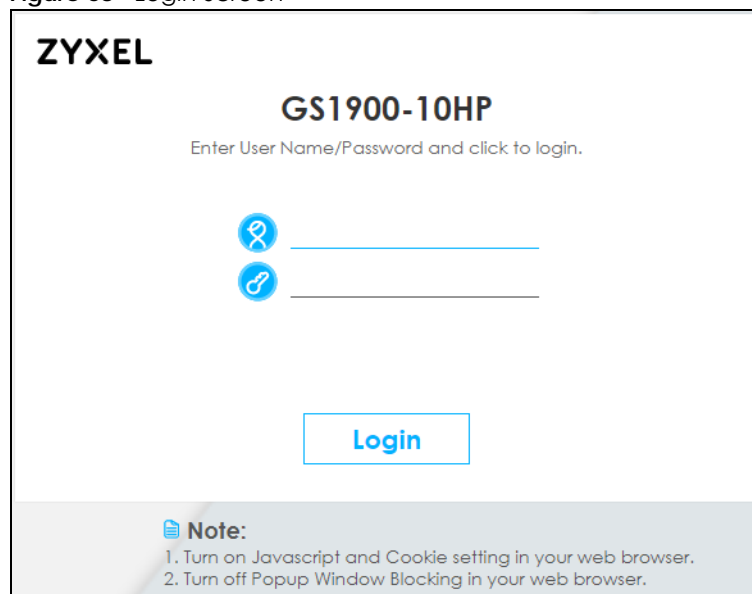

**ZYXEL**

**GS1900-10HP**

Enter User Name/Password and click to login.

**Login**

**Note:**

1. Turn on Javascript and Cookie setting in your web browser.
2. Turn off Popup Window Blocking in your web browser.

- 3 Enter the user name (default: "admin") and password (default: "1234").

- 4 Click **Login**. If you logged in using the default user name and password, getting start appears. The **Getting Started** screen appears every time you log in using the default user name and default password.
- 5 If you did not change the default administrator password and/or SNMP community values, a warning screen displays each time you log into the Web Configurator. Click **Password / SNMP** to open a screen where you can change the administrator and SNMP passwords simultaneously. Otherwise, click Ignore to close it.

**Figure 69** Web Configurator: Warning

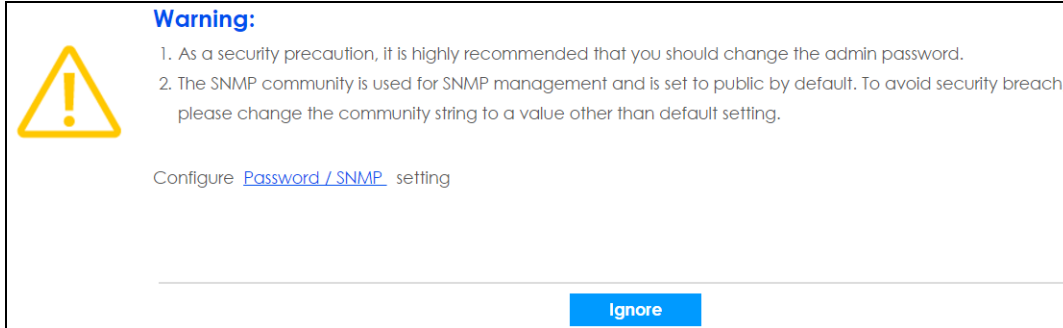

**Figure 70** Web Configurator: Password

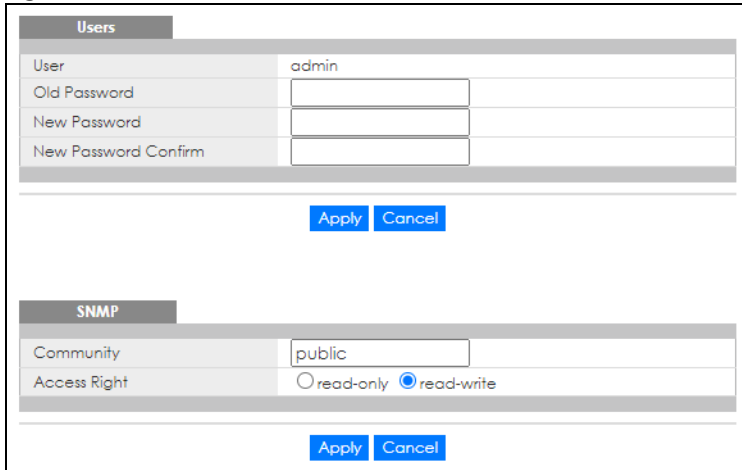

Change the default administrator and/or SNMP passwords, and then click **Apply** to save your changes.

Table 11 Web Configurator: Password > Users/SNMP

LABEL	DESCRIPTION
Users	Use this section to set the admin login password.
User	This is the default administrator account with the "admin" user name. You cannot change the default administrator user name.
Old Password	Type the existing system password ( <b>1234</b> is the default password when shipped).
New Password	Enter your new system password using the keyboard characters ("a – z", "A – Z", "0 – 9", "~!@#\$\$%^&*()_+`-={} :;<>./\"). The allowed string length is 1 to 64.
New Password Confirm	Re-enter your new system password for confirmation.
Apply	Click <b>Apply</b> to save your changes to the Switch's run-time memory. The Switch loses these changes if it is turned off or loses power, so use the <b>Save</b> link on the top navigation panel to save your changes to the non-volatile memory when you are done configuring.
Cancel	Click <b>Cancel</b> to begin configuring the password section afresh.

Table 11 Web Configurator: Password &gt; Users/SNMP (continued)

LABEL	DESCRIPTION
SNMP	Use this section to specify the SNMP community and access right values.
Community	Enter a string identifying the community name that this entry should belong to. The allowed string length is 1 to 20, and the allowed content is ASCII characters from 33 to 126.
Access Right	Select the access mode for this entry. The possible values are <b>Read-Only</b> and <b>Read-Write</b> .
Apply	Click <b>Apply</b> to save your changes to the Switch's run-time memory. The Switch loses these changes if it is turned off or loses power, so use the <b>Save</b> link on the top navigation panel to save your changes to the non-volatile memory when you are done configuring.
Cancel	Click <b>Cancel</b> to begin configuring this screen afresh.

## 5.3 Navigating the Web Configurator

The following summarizes how to navigate the Web Configurator from the **Getting Started** screen. This guide uses the GS1900-10HP and GS1900-24HP screens as an example. The screens may vary slightly for different models.

Figure 71 Web Configurator's Main Screen

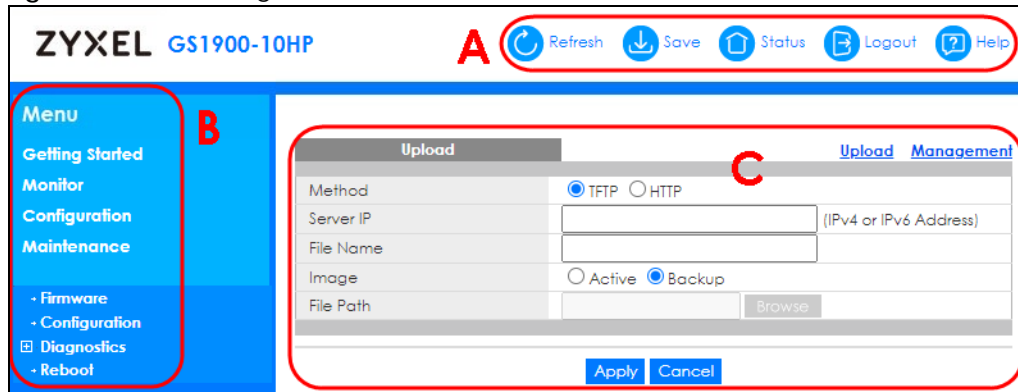

The Web Configurator's main screen is divided into these parts:

- **A** – Title Bar
- **B** – Navigation Panel
- **C** – Main Window

### 5.3.1 Title Bar

The title bar provides some useful links that always appear over the screens below, regardless of how deep into the Web Configurator you navigate.

Figure 72 Title Bar



The icons provide the following functions.

Table 12 Title Bar: Web Configurator Icons

LABEL	DESCRIPTION
Refresh	Click <b>Refresh</b> to reload the page.
Save	Click this to apply your changes to the Switch's run-time memory. The Switch loses these changes if it is turned off or loses power, so use the <b>Save</b> link on the top navigation panel to save your changes to the non-volatile memory when you are done configuring.
Status	Click this to display basic information about the Switch.
Logout	Click this to log out of the Web Configurator.
Help	Click this to open the help page for the current screen.

Click **Logout** in a screen to exit the Web Configurator. You have to log in with your password again after you log out. This is recommended after you finish a management session for security reasons.

## 5.3.2 Navigation Panel

Use the menu items on the navigation panel to open screens to configure Switch features. The following sections introduce the Switch's navigation panel menus and their screens.

Figure 73 Navigation Panel

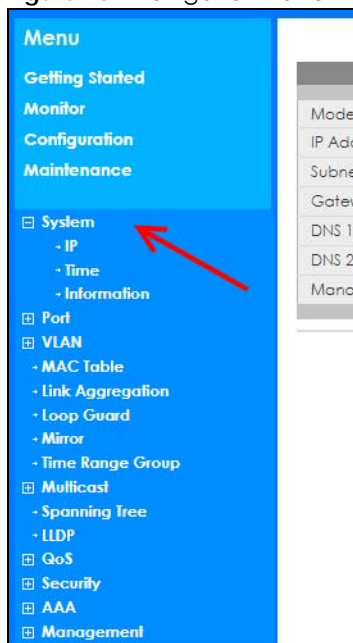

### Getting Started

Getting Started displays general device information, system status, system resource usage, and interface status.

For details on Getting Started features, see [Chapter 6 on page 61](#).

## Monitor Menu

The monitor menu screens display status and statistics information.

Table 13 Monitor Menu Screens Summary

FOLDER OR LINK	TAB	FUNCTION
System		This link takes you to a screen where you can see general identification information for the Switch.
IP	IPv4	This link takes you to a screen where you can see an IPv4 interface and the IPv4 settings on the Switch.
	IPv6	This link takes you to a screen where you can see an IPv6 interface and the IPv6 settings on the Switch.
Information		This link takes you to a screen that displays general system information: system name, system location, and system contact.
Port		This link takes you to screens where you can see speed, flow control and priority settings of individual Switch ports.
Port	Status	This link takes you to a screen to view the statistics of individual Switch ports.
	Port Counters	This link takes you to a screen to view the interface, port 1 interface mib counters, port 1 etherlike mib counters, port 1 RMON mib counters settings of individual Switch ports.
	Bandwidth Utilization	This link takes you to a screen to view the Tx and Rx bandwidth utilization of individual Switch ports.
PoE		This link takes you to a screen to view the current amount of power that PDs are receiving from the Switch.
Bandwidth Management		This link takes you to a screen to view the egress global burst and port rate for individual Switch ports.
Storm Control		This link takes you to a screen that displays broadcast filters.
VLAN		This link takes you to screens where you can see port-based or 802.1Q VLAN (depending on what you configured in the Switch Setup menu). You can also see a protocol based VLAN or a subnet based VLAN in these screens.
VLAN	VLAN	This link takes you to a screen to view the Switch's VLAN settings.
	Port	This link takes you to a screen to view the Switch's port setting in VLAN.
	VLAN Port	This link takes you to a screen to view the Switch's VLAN port settings.
Guest VLAN		This link takes you to a screen to view the Switch's guest VLAN settings.
Voice VLAN		This link takes you to a screen to view the Switch's global and port voice VLAN settings for voice traffic.
MAC Table		This link takes you to a screen where you can view the MAC address and VLAN ID of a device attach to a port. You can also view what kind of MAC address it is.
Link Aggregation		This link takes you to screen where you can view aggregate physical links to form one logical, higher-bandwidth link.
Loop Guard		This link takes you to a screen where you can view protection against network loops that occur on the edge of your network.
Multicast		This link takes you to screen where you can view various multicast features, IGMP snooping and create multicast VLANs.

Table 13 Monitor Menu Screens Summary (continued)

FOLDER OR LINK	TAB	FUNCTION
IGMP	VLAN	This link takes you to a screen to view the Switch's IGMP VLAN status.
	Statistics	This link takes you to a screen to view the Switch's IGMP statistics.
	Group	This link takes you to a screen to view the Switch's IGMP group information.
	Router	This link takes you to a screen to view the Switch's IGMP router information.
Spanning Tree		This link takes you to screens where you can view CIST, MST, STP preventing network loops.
	CIST	This link takes you to a screen to view the Switch's spanning tree CIST instance.
	CIST Port	This link takes you to a screen to view the Switch's spanning tree CIST port status.
	MST	This link takes you to a screen to view the Switch's spanning tree MST instance status.
	MST Port	This link takes you to a screen to view the Switch's spanning tree MST port status.
	STP Statistics	This link takes you to a screen to view the Switch's spanning tree STP statistics.
LLDP		This link takes you to screens where you can view the LLDP settings.
	Statistics	This link takes you to a screen to view the Switch's LLDP global and port statistics.
	Remote Information	This link takes you to a screen to view the Switch's LLDP remote device information.
	Overloading	This link takes you to a screen to view the Switch's LLDP port overloading status.
Security		This link takes you to screens where you can view the port security and 802.1X settings.
Port Security		This link takes you to a screen to view the Switch's port security status.
802.1X	Port	This link takes you to a screen to view the Switch's 802.1X port status.
	Authenticated Hosts	This link takes you to a screen to view the Switch's 802.1X security authenticated host status.
Management		This link takes you to screens where you can view the syslog and error disable status.
Syslog		This link takes you to a screen to view the Switch's logging filter settings and system logs.
Error Disable		This link takes you to a screen to view the Switch's global and port error disable status.

## Configuration Menu

Use the configuration menu screens to configure the Switch's features.

Table 14 Configuration Menu Screens Summary

FOLDER OR LINK	TAB	FUNCTION
System		This link takes you to a screen where you can configure general identification information and time settings for the Switch.

Table 14 Configuration Menu Screens Summary (continued)

FOLDER OR LINK	TAB	FUNCTION
IP	IPv4	This link takes you to a screen where you can enable an IPv4 interface and configure the IPv4 settings on the Switch.
	IPv6	This link takes you to a screen where you can enable an IPv6 interface and configure the IPv6 settings on the Switch.
Time	System Time	This link takes you to a screen to configure the time of the system.
	SNTP Server	This link takes you to a screen to configure the SNTP server settings.
Information		This link takes you to a screen that configures general system information: system name, system location, and system contact.
Port		This link takes you to screens where you can configure speed, flow control and priority settings for individual Switch ports.
Port		This link takes you to a screen to view the Switch's port settings and select individual Switch ports for configuration.
EEE		This link takes you to a screen to view the Switch's port EEE (Energy-Efficient Ethernet) state and select ports for configuration.
PoE	Global	This link takes you to a screen where you can configure the global settings for the Switch to supply power over Ethernet (PoE).
	Port	This link takes you to a screen where you can configure port PoE settings.
Bandwidth Management		This link takes you to a screen where you can view and configure the egress global burst and port rate.
Storm Control		This link takes you to a screen to set up broadcast filters.
VLAN		This link takes you to screens where you can configure VLAN, guest VLAN, and voice VLAN settings.
VLAN	VLAN	This link takes you to a screen where you can view and add/edit the VLAN settings.
	Port	This link takes you to a screen where you can view port settings and select VLANs for configuration.
	VLAN Port	This link takes you to a screen where you can view and configure the VLAN port settings.
Guest VLAN	Global	This link takes you to a screen where you can configure the global guest VLAN settings.
	Port	This link takes you to a screen where you can view the guest VLAN port settings and select VLAN ports for configuration.
Voice VLAN	Global	This link takes you to a screen where you can configure the global voice VLAN settings.
	OUI	This link takes you to a screen where you can view and edit/delete the OUI settings.
	Port	This link takes you to a screen where you can view the voice VLAN port settings and select a port for configuration.
MAC Table		This link takes you to a screen where you can configure the MAC address and VLAN ID of a device attach to a port. You can also configure what kind of MAC address it is.
	Static MAC	This link takes you to screens where you can configure static MAC addresses for a port. These static MAC addresses do not age out.
	Filtering MAC	This link takes you to a screen to set up filtering rules.
	Dynamic Age	This link takes you to a screen where you can enter the dynamic MAC aging time.



Table 14 Configuration Menu Screens Summary (continued)

FOLDER OR LINK	TAB	FUNCTION
Link Aggregation		This link takes you to a screen where you can logically aggregate physical links to form one logical, higher-bandwidth link.
	Global	This link takes you to a screen where you can configure the global link aggregation settings.
	LAG Management	This link takes you to a screen where you can configure the LAG management settings.
	LAG Port	This link takes you to a screen where you can view or edit the LAG port settings.
	LACP Port	This link takes you to a screen where you can view or edit the LACP port settings.
Loop Guard		This link takes you to screens where you can configure protection against network loops that occur on the edge of your network.
	Global	This link takes you to a screen where you can configure the global loop guard settings.
	Port	This link takes you to a screen where you can view or edit the port's loop guard settings.
Mirror		This link takes you to a screen where you can copy traffic from one port or ports to another port. This allowing you to examine the traffic from the first port without interference.
Time Range Group		This link takes you to a screen where you can view/define/delete time range (schedule) rules.
Multicast		This link takes you to a screen where you can configure various multicast features, IGMP snooping and create multicast VLANs.
IGMP	Global	This link takes you to a screen where you can configure the IGMP global settings.
	VLAN	This link takes you to a screen where you can view or edit the IGMP VLAN settings.
	Router Port	This link takes you to a screen where you can add or view the router port settings.
	Profile	This link takes you to a screen where you can add or view the IGMP profile settings.
	Throttling	This link takes you to a screen where you can view or edit the throttling settings.
Spanning Tree		This link takes you to screens where you can configure the RSTP/MRSTP/MSTP to prevent network loops.
	Global	This link takes you to a screen where you can configure the global settings.
	STP Port	This link takes you to a screen where you can view or edit the STP port settings.
	CIST	This link takes you to a screen where you can configure the CIST settings.
	CIST Port	This link takes you to a screen where you can view or edit the CIST port settings.
	MST	This link takes you to a screen where you can add/edit/delete the MST instance settings.
	MST Port	This link takes you to a screen where you can view or edit the MST port settings.

Table 14 Configuration Menu Screens Summary (continued)

FOLDER OR LINK	TAB	FUNCTION
LLDP		This link takes you to screens where you can configure the global, port, local information, MED network policy, and MED port settings.
	Global	This link takes you to a screen where you can configure the global LLDP settings.
	Port	This link takes you to a screen where you can view or edit the LLDP port settings.
	Local Information	This link takes you to a screen where you can view or edit the LLDP local information settings.
	MED Network Policy	This link takes you to a screen where you can add/edit/delete the LLDP MED network policy settings.
	MED Port	This link takes you to a screen where you can view or edit the LLDP MED port settings.
QoS		This link takes you to screens where you can configure the general and trust mode settings.
General	Port	This link takes you to a screen where you can view or edit the QoS port settings.
	Queue	This link takes you to a screen where you can configure queuing with associated queue weights for each port.
	CoS Mapping	This link takes you to a screen where you can configure the CoS to queue mapping and Queue to CoS mapping settings.
	DSCP Mapping	This link takes you to a screen where you can configure the DSCP to queue and queue to DSCP mapping settings.
	IP Precedence Mapping	This link takes you to a screen where you can configure the IP precedence to queue and queue to IP precedence mapping settings.
Trust Mode	Global	This link takes you to a screen where you can configure the global trust mode setting.
	Port	This link takes you to a screen where you can view or edit the QoS port trust mode setting.
Security		This link takes you to screens where you can configure the port security, port isolation, 802.1X and DoS settings.
Port Security	Global	This link takes you to a screen where you can enable the global port security.
	Port	This link takes you to a screen where you can view or edit the port's security settings.
Port Isolation		This link takes you to a screen where you can view the state or enable/disable port isolation.
802.1X	Global	This link takes you to a screen where you can enable the global 802.1X security setting.
	Port	This link takes you to a screen where you can view or edit the 802.1X port security settings.
DoS	Global	This link takes you to a screen where you can enable Denial of Service (DoS).
	Port	This link takes you to a screen where you can view or edit the Switch's port DoS state.
AAA		This link takes you to a screen where you can view authentication, authorization and accounting services through external servers. The external servers can be either RADIUS (Remote Authentication Dial-In User Service) or TACACS+ (Terminal Access Controller Access-Control System Plus).

Table 14 Configuration Menu Screens Summary (continued)

FOLDER OR LINK	TAB	FUNCTION
Auth Method		This link takes you to a screen where you can add/edit/delete an authentication method.
RADIUS		This link takes you to a screen where you can add/edit/delete RADIUS server settings.
TACACS+		This link takes you to a screen where you can add/edit/delete TACACS+ server settings.
Management		This link takes you to screens where you can configure the syslog, SNMP, error disable, HTTP/HTTPS, users and remote access control.
Syslog	Global	This link takes you to a screen where you can enable syslog (system logging).
	Local	This link takes you to a screen where you can add/edit/delete the local syslog settings.
	Remote	This link takes you to a screen where you can add/edit/delete the remote syslog settings.
SNMP	Global	This link takes you to a screen where you can enable SNMP (Simple Network Management Protocol).
	Community	This link takes you to a screen where you can add/delete the SNMP community settings.
	Group	This link takes you to a screen where you can add/edit/delete the SNMP group settings.
	User	This link takes you to a screen where you can add/edit/delete the SNMP users' settings.
	Trap	This link takes you to a screen where you can enable the SNMP traps.
	Trap Destination	This link takes you to a screen where you can add/edit/delete the SNMP trap host settings.
Error Disable		This link takes you to a screen where you can configure the error disable settings.
HTTP/HTTPS	HTTP	This link takes you to a screen where you can enable and configure the management HTTP settings.
	HTTPS	This link takes you to a screen where you can enable and configure the management HTTPS settings.
TELNET/SSH	TELNET	This link takes you to a screen where you can enable remote Telnet access.
	SSH	This link takes you to a screen where you can enable SSH connection.
Users		This link takes you to a screen where you can configure the management users' settings.
Remote Access Control		This link takes you to a screen where you can enable remote access control and add/edit/delete profile settings.

## Maintenance Menu

Use the maintenance menu screens to manage configuration and firmware files, run diagnostics, and reboot or shut down the Switch.

Table 15 Maintenance Menu Screens Summary

FOLDER OR LINK	TAB	FUNCTION
Firmware	Upload	This link takes you to a screen where you can manage the firmware upload settings.
	Management	This link takes you to a screen where you can view the active/backup firmware image information and activate an image.
Configuration	Backup	This link takes you to a screen where you can backup your current Switch configuration and log files to a server or as a local file to your computer.
	Restore	This link takes you to a screen where you can restore a previously saved configuration from a server or your computer.
	Management	This link takes you to a screen where you can replace the startup and backup configuration files.
	Factory Default	This link takes you to a screen where you can reset the Switch back to factory default settings.
Diagnostics		This link takes you to screens where you can view system logs and test ports.
Port Test		This link takes you to a screen where you can perform an internal loop-back test on an Ethernet port.
PING	IPv4	This link takes you to a screen where you can ping an IPv4 server.
	IPv6	This link takes you to a screen where you can ping an IPv6 server.
Trace Route		This link takes you to a screen where you can print the route that IP packets take to a network host.
Reboot		This link takes you to a screen where you can restart the Switch without turning the power off.

# CHAPTER 6

## Getting Started

### 6.1 Overview

Use the **Getting Started** screens to check status information about the Switch.

#### 6.1.1 What You Can Do in this Chapter

The main **Getting Started** screen (Section 6.2 on page 61) displays the Switch's general device information, system status, system resource usage, and interface status. You can also display other status screens for more information.

### 6.2 Getting Started

This screen is the first thing you see when you log into the Switch. It also appears every time you click the **Getting Started** icon in the navigation panel. The **Getting Started** displays general device information, system status, system resource usage, and interface status in widgets.

Figure 74 Getting Started

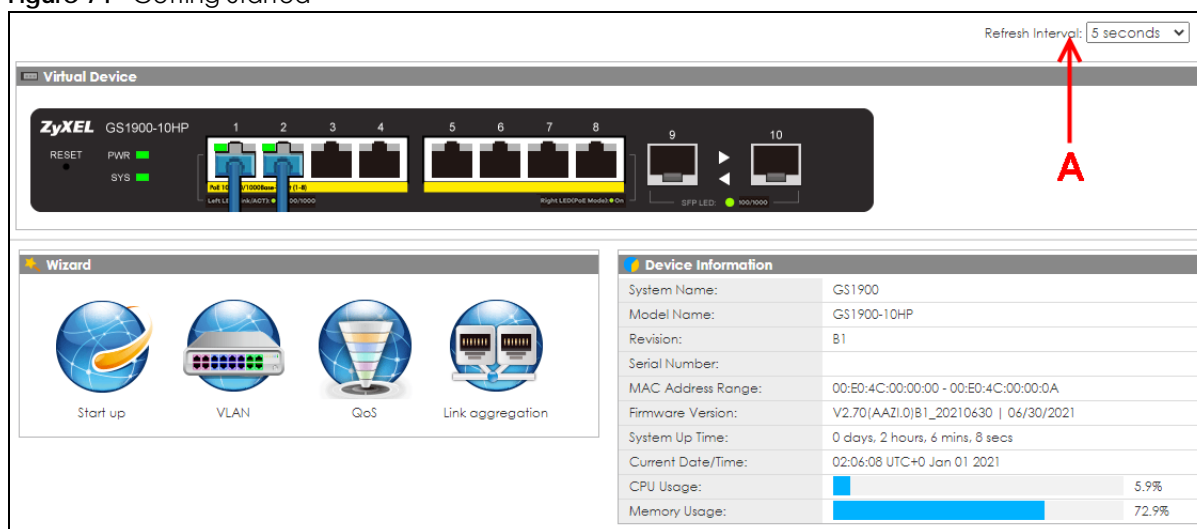

The following table describes the labels in this screen.

Table 16 Getting Started

LABEL	DESCRIPTION
Refresh Interval (A)	Use the drop-box to select: None, 5 seconds, 10 seconds, 15 seconds, 20 seconds, 25 seconds, or 30 seconds.
Virtual Device	Displays an image of the Switch.

Table 16 Getting Started (continued)

LABEL	DESCRIPTION
Wizard	Displays the following links: Start up, VLAN, QoS, and Link aggregation.
Device Information	
System Name	This field displays the name used to identify the Switch on any network.
Model Name	This field displays the model name of this Switch.
Revision	This field displays the hardware revision number of this Switch.
Serial Number	This field displays the serial number of this Switch.
MAC Address Range	This field displays the MAC addresses used by the Switch. Each physical port or wireless radio has one MAC address. The first MAC address is assigned to the Ethernet LAN port, the second MAC address is assigned to the first radio, and so on.
Firmware Version	This field displays the version number and date of the firmware the Switch is currently running.
System Up Time	This field displays how long the Switch has been running since it last restarted or was turned on.
Current Date/Time	This field displays the current date and time in the Switch. The format is hh:mm:ss yyyy-mm-dd.
CPU Usage	This field displays the Switch's recent CPU usage.
Memory Usage	This field displays the Switch's recent memory usage.

## 6.2.1 Wizard

Wizard displays start up, VLAN, QoS, and link aggregation.

For details on Wizard features, see system [Chapter 7 on page 74](#), VLAN [Chapter 9 on page 86](#), QoS [Chapter 29 on page 198](#), and link aggregation [Chapter 11 on page 95](#).

### Start up

In start up, you can set up IP or DNS, set up your user name or password, and view finished results.

In order to set up your IP or DNS, please do the following. Click **Getting Started > Start up > 1 Step 1 Set up IP** to access this screen.

Figure 75 Getting Started &gt; Start up &gt; 1 Step 1 Set up IP

**1 Step 1**  
Set up IP

**2 Step 2**  
Set up user name/password

**3 Step 3**  
Finish

**Step 1 Set up IP**

Host Name :

IP Address :

Subnet Mask :

Gateway :

DNS :

NTP(Network Time Protocol) :

Each field is described in the following table.

Table 17 Getting Started &gt; Start up &gt; 1 Step 1 Set up IP

LABEL	DESCRIPTION
Host Name	This field displays a host name.
IP Address	The Switch needs an IP address for it to be managed over the network. The factory default IP address is 192.168.1.1.
Subnet Mask	The subnet mask specifies the network number portion of an IP address. The factory default subnet mask is 255.255.255.0.
Gateway	Type the IP address of the default outgoing gateway in dotted decimal notation, for example 192.168.1.254.
DNS	DNS (Domain Name System) is for mapping a domain name to its corresponding IP address and vice versa. Enter a domain name server IP address in order to be able to use a domain name instead of an IP address.
NTP (Network Time Protocol)	This field displays the NTP time servers from which the Switch gets the time and date.
Next	Click <b>Next</b> to show the next screen.

After clicking **Next**, the set up your user name screen appears.

Figure 76 Getting Started &gt; Start up &gt; 2 Step 2 Set up user name/password

The screenshot shows a three-step configuration process. Step 1 is 'Set up IP', Step 2 is 'Set up user name/password', and Step 3 is 'Finish'. The current screen is Step 2, which contains two input fields: 'User Name' and 'Password'. Navigation buttons 'Previous', 'Next', and 'Finish' are located at the bottom right.

Each field is described in the following table.

Table 18 Getting Started &gt; Start up &gt; 2 Step 2 Set up user name/password

LABEL	DESCRIPTION
Username	The default user name is <b>admin</b> and associated default password is <b>1234</b> . Enter a user name using the keyboard characters ("a - z", "A - Z", "0 - 9", ~!@#\$\$%^&*()_+`-={} :;<>.\) for the user. The allowed string length is 1 to 32.
Password	The default user name is <b>admin</b> and associated default password is <b>1234</b> . Enter a new password using the keyboard characters ("a - z", "A - Z", "0 - 9", ~!@#\$\$%^&*()_+`-={} :;<>.\) for the user. The allowed string length is 1 to 64.
Previous	Click <b>Previous</b> to show the previous screen.
Next	Click <b>Next</b> to show the next screen.

After clicking **Next**, the finish screen appears.



Figure 77 Getting Started &gt; Start up &gt; 3 Step 3 Finish

**1 Step 1**  
Set up IP

**2 Step 2**  
Set up user name/password

**3 Step 3**  
Finish

**Step 3 Finish**

 Host Name : GS1900  
 IP Address : 192.168.1.1  
 Subnet Mask : 255.255.255.0  
 Gateway : 0.0.0.0  
 DNS : 0.0.0.0  
 NTP(Network Time Protocol) :  
 User Name :  
 Password :

Previous Next Finish

Each field is described in the following table.

Table 19 Getting Started &gt; Start up &gt; 3 Step 3 Finish

LABEL	DESCRIPTION
Host Name	This field displays a host name.
IP Address	The Switch needs an IP address for it to be managed over the network. The factory default IP address is 192.168.1.1.
Subnet Mask	The subnet mask specifies the network number portion of an IP address. The factory default subnet mask is 255.255.255.0.
Gateway	Type the IP address of the default outgoing gateway in dotted decimal notation, for example 192.168.1.254.
DNS	DNS (Domain Name System) is for mapping a domain name to its corresponding IP address and vice versa. Enter a domain name server IP address in order to be able to use a domain name instead of an IP address.
NTP (Network Time Protocol)	This field displays the NTP time servers from which the Switch gets the time and date.
Username	The default user name is <b>admin</b> and associated default password is <b>1234</b> .
Password	The default user name is <b>admin</b> and associated default password is <b>1234</b> .
Previous	Click <b>Previous</b> to show the previous screen.
Finish	Review the information and click <b>Finish</b> to create the task.

## VLAN

In VLAN, you can create VLAN, tag VLAN setting, and view finished results.

In order to create VLAN, please do the following. Click **Getting Started > VLAN > 1 Step 1 Create VLAN** to access this screen.

**Figure 78** Getting Started > VLAN > 1 Step 1 Create VLAN

The screenshot shows a three-step process for creating a VLAN. Step 1, 'Create VLAN', is the current step and is highlighted in blue. It contains two input options: a text box for 'Create VLAN ID (1-4094):' and a dropdown menu for 'Edit VLAN ID:' with 'VLAN 1' selected. Step 2, 'Tag VLAN setting', and Step 3, 'Finish', are shown in grey. At the bottom, there are 'Previous', 'Next', and 'Finish' buttons.

Each field is described in the following table.

Table 20 Getting Started > VLAN > 1 Step 1 Create VLAN

LABEL	DESCRIPTION
Create VLAN ID (1–4094)	Type a number between <b>1</b> and <b>4094</b> to create a VLAN ID.
Edit VLAN ID	Select from the drop-box a VLAN ID.
Next	Click <b>Next</b> to show the next screen.

After clicking Next, the tag VLAN setting screen appears.

Figure 79 Getting Started &gt; VLAN &gt; 2 Step 2 Tag VLAN Setting

The screenshot displays the 'Step 2 Tag VLAN setting' configuration interface. At the top, there are three step indicators: '1 Step 1 Create VLAN' (blue), '2 Step 2 Tag VLAN setting' (blue and active), and '3 Step 3 Finish' (grey). Below the steps, the main configuration area is titled 'Step 2 Tag VLAN setting' and contains three large grey rectangular fields. The first field is labeled 'Currently VLAN ID: 1'. The second field is labeled 'Tag'. The third field is labeled 'Untag' and contains a grid of port icons: Port01 through Port10 (arranged in two columns of five) and LAG1 through LAG8 (arranged in two columns of four). At the bottom right of the configuration area, there are three buttons: 'Previous' (blue), 'Next' (blue), and 'Finish' (grey).

Each field is described in the following table.

Table 21 Getting Started &gt; VLAN &gt; 2 Step 2 Tag VLAN Setting

LABEL	DESCRIPTION
Currently VLAN ID	This field displays the VLAN identification number.
Tag	Ports belonging to the specified VLAN tag all outgoing frames transmitted.
Untag	Ports belonging to the specified VLAN do not tag all outgoing frames transmitted.
Previous	Click <b>Previous</b> to show the previous screen.
Next	Click <b>Next</b> to show the next screen.

After clicking **Next**, the finish screen appears.

Figure 80 Getting Started &gt; VLAN&gt; 3 Step 3 Finish

The screenshot displays the 'Step 3 Finish' configuration screen. At the top, there are three step indicators: '1 Step 1 Create VLAN', '2 Step 2 Tag VLAN setting', and '3 Step 3 Finish'. The main content area is titled 'Step 3 Finish' and includes a checkmark icon. Below the title, there are two main sections: 'Currently VLAN ID: 1' and 'Tag'. The 'Tag' section is a large empty grey box. To the right, the 'Untag' section shows a grid of 15 ports: Port01 through Port10, and Utag01 through Utag03. At the bottom right, there are three buttons: 'Previous' (blue), 'Next' (grey), and 'Finish' (blue).

Each field is described in the following table.

Table 22 Getting Started &gt; VLAN &gt; 3 Step 3 Finish

LABEL	DESCRIPTION
Currently VLAN ID	This field displays the VLAN identification number.
Tag	Ports belonging to the specified VLAN tag all outgoing frames transmitted.
Untag	Ports belonging to the specified VLAN do not tag all outgoing frames transmitted.
Previous	Click <b>Previous</b> to show the previous screen.
Finish	Review the information and click <b>Finish</b> to create the task.

## QoS

In QoS, you can create QoS settings, and view finished results.

In order to create QoS settings, please do the following. Click **Getting Started > QoS > 1 Step 1 QoS (Quality of Service)** to access this screen.

Figure 81 Getting Started &gt; QoS &gt; 1 Step 1 QoS (Quality of Service)

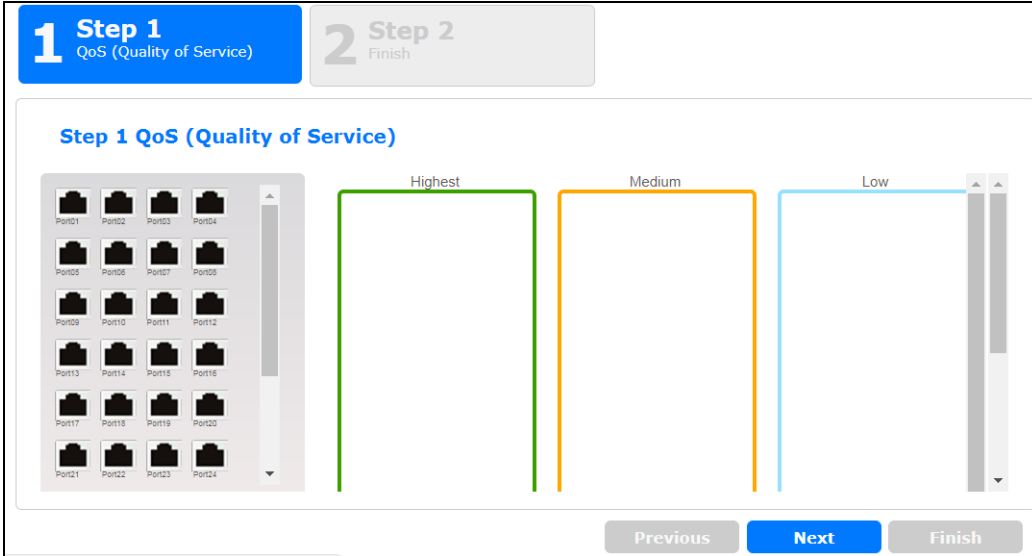

Each field is described in the following table.

Table 23 Getting Started &gt; QoS &gt; 1 Step 1 QoS (Quality of Service)

LABEL	DESCRIPTION
Highest	Click and drag icons located on the left to desired preference.
Medium	Click and drag icons located on the left to desired preference.
Low	Click and drag icons located on the left to desired preference.
Next	Click <b>Next</b> to show the next screen.

After clicking **Next**, the finish screen appears.

Figure 82 Getting Started &gt; QoS &gt; 2 Step 2 Finish

The screenshot displays a two-step process. Step 1, 'QoS (Quality of Service)', is completed. Step 2, 'Finish', is the current step. The summary section for Step 2 contains a checkmark icon and three empty boxes for 'Highest', 'Medium', and 'Low' quality levels. Navigation buttons 'Previous', 'Next', and 'Finish' are located at the bottom right.

Each field is described in the following table.

Table 24 Getting Started &gt; QoS &gt; 2 Step 2 Finish

LABEL	DESCRIPTION
Highest	Displays summary results.
Medium	Displays summary results.
Low	Displays summary results.
Previous	Click <b>Previous</b> to show the previous screen.
Finish	Review the information and click <b>Finish</b> to create the task.

## Link Aggregation

In link aggregation, you can link aggregation and view finished results.

In order to create link aggregation settings, please do the following. Click **Getting Started > Link aggregation > 1 Step 1 Link aggregation** to access this screen.

Figure 83 Getting Started &gt; Link aggregation &gt; 1 Step 1 Link aggregation

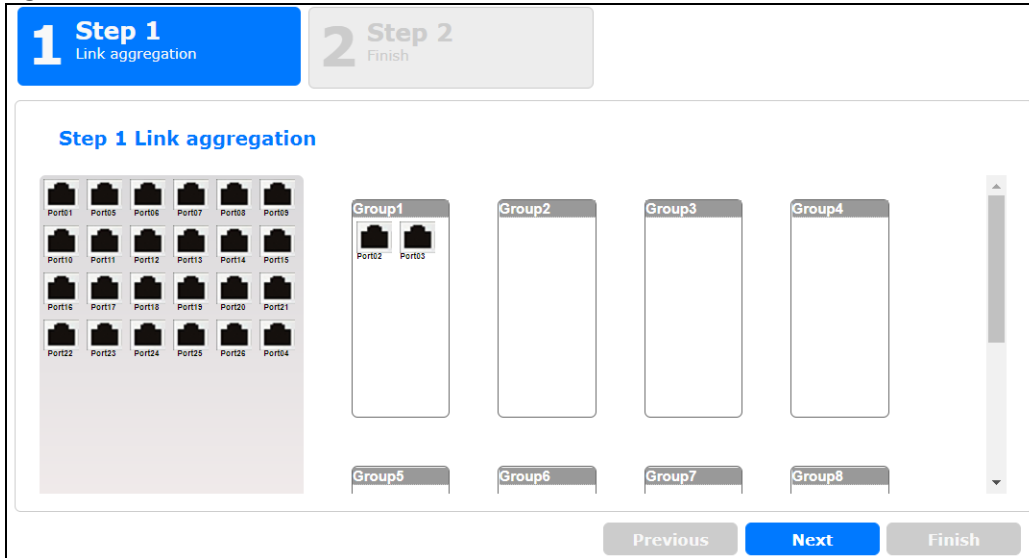

Each field is described in the following table.

Table 25 Getting Started &gt; Link aggregation &gt; 1 Step 1 Link aggregation

LABEL	DESCRIPTION
Group 1	Click and drag icons located on the left to desired preference.
Group 2	Click and drag icons located on the left to desired preference.
Group 3	Click and drag icons located on the left to desired preference.
Group 4	Click and drag icons located on the left to desired preference.
Group 5	Click and drag icons located on the left to desired preference.
Group 6	Click and drag icons located on the left to desired preference.
Group 7	Click and drag icons located on the left to desired preference.
Group 8	Click and drag icons located on the left to desired preference.
Next	Click <b>Next</b> to show the next screen.

After clicking **Next**, the finish screen appears.

Figure 84 Getting Started &gt; Link aggregation &gt; 2 Step 2 Finish

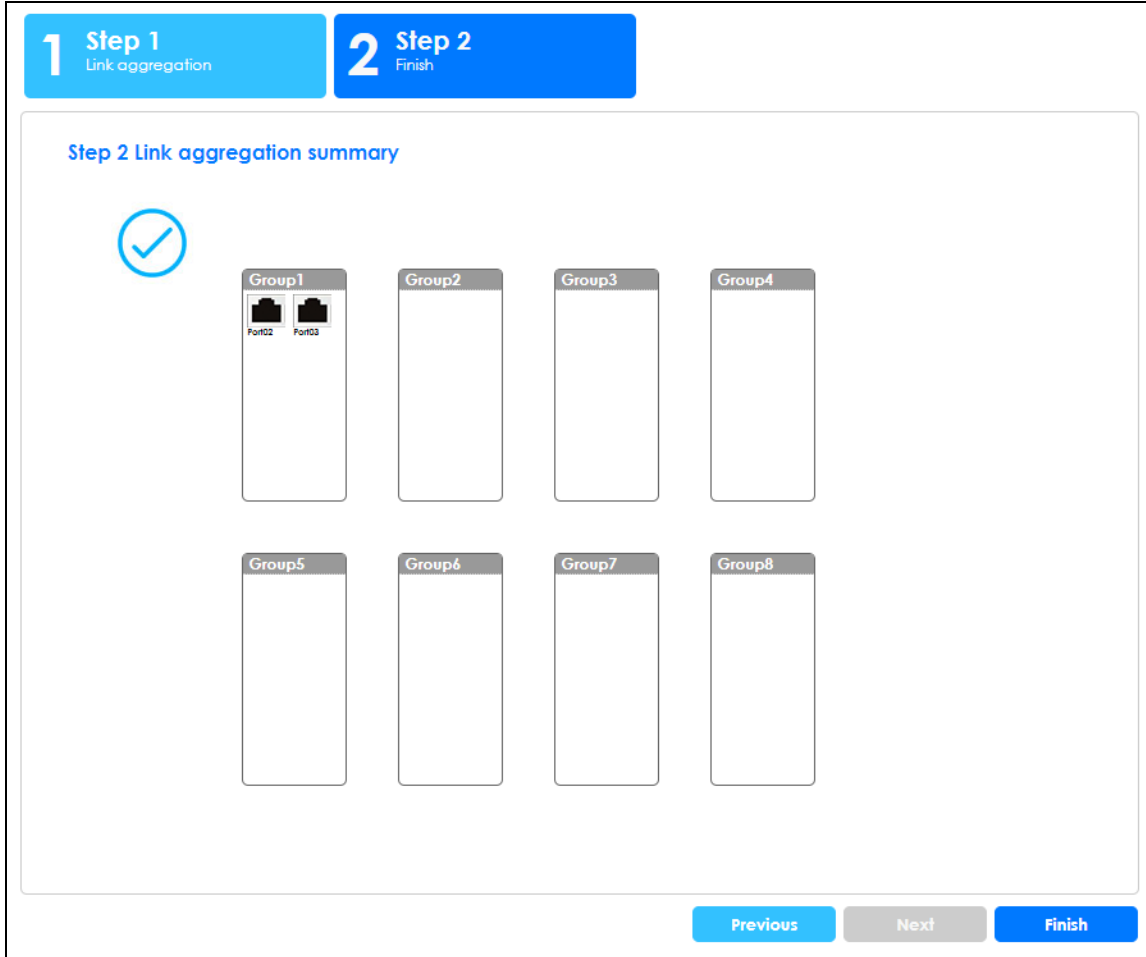

Each field is described in the following table.

Table 26 Getting Started &gt; Link aggregation &gt; 2 Step 2 Finish

LABEL	DESCRIPTION
Group 1	Displays summary results.
Group 2	Displays summary results.
Group 3	Displays summary results.
Group 4	Displays summary results.
Group 5	Displays summary results.
Group 6	Displays summary results.
Group 7	Displays summary results.
Group 8	Displays summary results.
Previous	Click <b>Previous</b> to show the previous screen.
Finish	Review the information and click <b>Finish</b> to create the task.



---

# PART II

## Technical Reference

---

# CHAPTER 7

## Monitor: System

### 7.1 Overview

This section provides information for **System** in **Monitor**. Use the **System** screens to view general Switch settings.

#### 7.1.1 What You Can Do in this Chapter

- The **IP** screen ([Section 7.2 on page 74](#)) displays IPv4 and IPv6.
- The **Information** screen ([Section 7.3 on page 75](#)) displays the system information.

### 7.2 IP Settings

The Switch needs an IP address for it to be managed over the network. The factory default IP address is 192.168.1.1. The subnet mask specifies the network number portion of an IP address. The factory default subnet mask is 255.255.255.0.

#### 7.2.1 IPv4 Settings

Use this screen to view the Switch's IPv4 information. Click **Monitor > System > IP > IPv4** to open this screen.

**Figure 85** Monitor > System > IP > IPv4

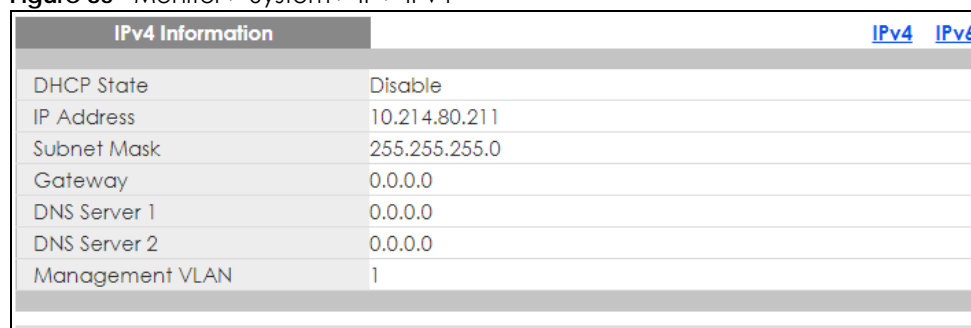

IPv4 Information		IPv4	IPv6
DHCP State	Disable		
IP Address	10.214.80.211		
Subnet Mask	255.255.255.0		
Gateway	0.0.0.0		
DNS Server 1	0.0.0.0		
DNS Server 2	0.0.0.0		
Management VLAN	1		

The following table describes the labels in this screen.

**Table 27** Monitor > System > IP > IPv4

LABEL	DESCRIPTION
DHCP State	This field displays the state of Dynamic Host Configuration Protocol RFC 2131 and RFC 2132 (DHCP).
IP Address	This field displays IP address of the Switch in the IP domain.

Table 27 Monitor &gt; System &gt; IP &gt; IPv4 (continued)

LABEL	DESCRIPTION
Subnet Mask	This field displays the subnet mask of the Switch in the IP domain.
Gateway	This field displays the IP address of the default outgoing gateway in dotted decimal notation, for example 192.168.1.254.
DNS Server 1	DNS (Domain Name System) is for mapping a domain name to its corresponding IP address and vice versa. This field displays a domain name server IP address, enabling the use of a domain.
DNS Server 2	DNS (Domain Name System) is for mapping a domain name to its corresponding IP address and vice versa. This field displays a domain name server IP address, enabling the use of a domain.
Management VLAN	This field displays the management VLAN.

## 7.2.2 IPv6 Settings

Use this screen to view the Switch's IPv6 information. Click **Monitor > System > IP > IPv6** to open this screen.

Figure 86 Monitor &gt; System &gt; IP &gt; IPv6

IPv6 Information	
Auto Configuration	Enable
IPv6 Address	fe80::4e9e:ffff:fe72:4a87 / 64
IPv6 Gateway	::
DHCPv6 Client	Disable

The following table describes the labels in this screen.

Table 28 Monitor &gt; System &gt; IP &gt; IPv6

LABEL	DESCRIPTION
Auto Configuration	This field displays auto configuration.
IPv6 Address	This field displays IP address of the Switch in the IP domain.
IPv6 Gateway	This field displays the IP address of the default outgoing gateway.
DHCPv6 Client	This field displays the Switch's DHCP settings when it is acting as a DHCPv6 client.

## 7.3 Information

In the navigation panel, click **Monitor > System > Information > System Information** to display the screen as shown. You can view system information.

Figure 87 Monitor &gt; System &gt; Information &gt; System Information

System Information	
System Name	GS1900
System Location	Location
System Contact	Contact

The following table describes the labels in this screen.

Table 29 Monitor > System > Information > System Information

<b>LABEL</b>	<b>DESCRIPTION</b>
System Name	This field displays the descriptive name of the Switch for identification purposes.
System Location	This field displays the geographic location of the Switch for identification purposes.
System Contact	This field displays the person in charge of the Switch for identification purposes.

# CHAPTER 8

## Monitor: Port

### 8.1 Overview

This section provides information for **Port** in **Monitor**. Use the **Port** screens to view general Switch port settings.

#### 8.1.1 What You Can Do in this Chapter

- The **Port** screen (Section 8.2 on page 77) displays status, port counters, and bandwidth utilization.
- The **PoE** screen (Section 8.3 on page 81) displays PoE.
- The **Bandwidth Management** screen (Section 8.4 on page 83) displays bandwidth control.
- The **Storm Control** screen (Section 8.5 on page 84) displays port settings of the Switch.

### 8.2 Port Settings

Use this screen to view Switch port settings.

#### 8.2.1 Status

Use this screen to view the Switch's port statistics. Click **Monitor > Port > Port > Status** to access this screen.

Figure 88 Monitor > Port > Port > Status

Status				Status		Port Counters		Bandwidth Utilization	
Port	Port Name	State	Link Status	Speed	Duplex	FlowCtrl	Status	Type	
1		Enable	Down	Auto	Auto		Disable	Copper	
2		Enable	Down	Auto	Auto		Disable	Copper	
3		Enable	Down	Auto	Auto		Disable	Copper	
4		Enable	Down	Auto	Auto		Disable	Copper	
5		Enable	Down	Auto	Auto		Disable	Copper	
6		Enable	Down	Auto	Auto		Disable	Copper	
7		Enable	Down	Auto	Auto		Disable	Copper	
8		Enable	Down	Auto	Auto		Disable	Copper	
21		Enable	Down	Auto	Auto		Disable	Copper	
22		Enable	Up	Auto-1000M	Auto-full		Disable	Copper	
23		Enable	Down	Auto	Auto		Disable	Copper	
24		Enable	Up	Auto-1000M	Auto-full		Disable	Copper	
25		Enable	Down	Auto	Auto		Disable	Fiber	
26		Enable	Down	Auto	Auto		Disable	Fiber	

Each field is described in the following table.

Table 30 Monitor &gt; Port &gt; Port &gt; Status

LABEL	DESCRIPTION
Port	This is the port index number.
Port Name	A descriptive name that identifies this port.
State	This is port admin setting state.
Link Status	This field displays <b>Up</b> , <b>Down</b> or <b>Not Present</b> . It displays <b>Up</b> when the port is linked up or <b>Down</b> when it is not. When no any physical port is binding with this group, it displays <b>Not Present</b> .
Speed	View the speed of the Ethernet connection on this port.
Duplex	View the duplex mode of the Ethernet connection on this port.
FlowCtrl Status	A concentration of traffic on a port decreases port bandwidth and overflows buffer memory causing packet discards and frame losses. Flow Control is used to regulate transmission of signals to match the bandwidth of the receiving port.
Type	View the type on this port.

## 8.2.2 Port Counters

Use this screen to view the Switch's port counters settings. Click **Monitor > Port > Port > Port Counters** to access this screen.

Figure 89 Monitor &gt; Port &gt; Port &gt; Port Counters (Port 1 Interface mib Counters)

Port Counters		Status	Port Counters	Bandwidth Utilization
Port	1	clear	refresh	
Mode	<input checked="" type="radio"/> All <input type="radio"/> Interface <input type="radio"/> Etherlike <input type="radio"/> RMON			
<b>Port 1 Interface mib Counters</b>				
ifInOctets	0			
ifInUcastPkts	0			
ifInNUcastPkts	0			
ifInDiscards	0			
ifOutOctets	0			
ifOutUcastPkts	0			
ifOutNUcastPkts	0			
ifOutDiscards	0			
ifInMulticastPkts	0			
ifInBroadcastPkts	0			
ifOutMulticastPkts	0			
ifOutBroadcastPkts	0			

**Figure 90** Monitor > Port > Port > Port Counters (Port 1 Etherlike mib Counters)

Port 1 Etherlike mib Counters	
dot3StatsAlignmentErrors	0
dot3StatsFCSErrors	0
dot3StatsSingleCollisionFrames	0
dot3StatsMultipleCollisionFrames	0
dot3StatsDeferredTransmissions	0
dot3StatsLateCollisions	0
dot3StatsExcessiveCollisions	0
dot3StatsFrameTooLongs	0
dot3StatsSymbolErrors	0
dot3ControlInUnknownOpCodes	0
dot3InPauseFrames	0
dot3OutPauseFrames	0

**Figure 91** Monitor > Port > Port > Port Counters (Port 1 RMON mib Counters)

Port 1 RMON mib Counters	
etherStatsDropEvents	0
etherStatsOctets	0
etherStatsPkts	0
etherStatsBroadcastPkts	0
etherStatsMulticastPkts	0
etherStatsCRCAlignErrors	0
etherStatsUnderSizePkts	0
etherStatsOverSizePkts	0
etherStatsFragments	0
etherStatsJabbers	0
etherStatsCollisions	0
etherStatsPkts64Octets	0
etherStatsPkts65to127Octets	0
etherStatsPkts128to255Octets	0
etherStatsPkts256to511Octets	0
etherStatsPkts512to1023Octets	0
etherStatsPkts1024to1518Octets	0

Each field is described in the following table.

**Table 31** Monitor > Port > Port > Port Counters

LABEL	DESCRIPTION
Port Counters	
Port	This field displays the port.
Mode	This field displays the mode.
Port 1 Interface mib Counters	
ifInOctets	This field displays the ifInOctets.
ifInUcastPkts	This field displays the ifInUcastPkts.
ifInNUcastPkts	This field displays the ifInNUcastPkts.
ifInDiscards	This field displays the ifInDiscards.
ifOutOctets	This field displays the ifOutOctets.
ifOutUcastPkts	This field displays the ifOutUcastPkts.
ifOutNUcastPkts	This field displays the ifOutNUcastPkts.
ifOutDiscards	This field displays the ifOutDiscards.
ifInMulticastPkts	This field displays the ifInMulticastPkts.
ifInBroadcastPkts	This field displays the ifInBroadcastPkts.

Table 31 Monitor &gt; Port &gt; Port &gt; Port Counters (continued)

LABEL	DESCRIPTION
ifOutMulticastPkts	This field displays the ifOutMulticastPkts.
ifOutBroadcastPkts	This field displays the ifOutBroadcastPkts.
Port 1 Etherlike mib Counters	
dot3StatsAlignmentErrors	This field displays the dot3StatsAlignmentErrors.
dot3StatsFCSErrors	This field displays the dot3StatsFCSErrors.
dot3StatsSingleCollisionFrames	This field displays the dot3StatsSingleCollisionFrames.
dot3StatsMultipleCollisionFrames	This field displays the dot3StatsMultipleCollisionFrames.
dot3StatsDeferredTransmissions	This field displays the dot3StatsDeferredTransmissions.
dot3StatsLateCollisions	This field displays the dot3StatsLateCollisions.
dot3StatsExcessiveCollisions	This field displays the dot3StatsExcessiveCollisions.
dot3StatsFrameTooLongs	This field displays the dot3StatsFrameTooLongs.
dot3StatsSymbolErrors	This field displays the dot3StatsSymbolErrors.
dot3ControlInUnkownOpcodes	This field displays the dot3ControlInUnkownOpcodes.
dot3InPauseFrames	This field displays the dot3InPauseFrames.
dot3OutPauseFrames	This field displays the dot3OutPauseFrames.
Port 1 RMON mib Counters	
etherStatsDropEvents	This field displays the etherStatsDropEvents.
etherStatsOctets	This field displays the etherStatsOctets.
etherStatsPkts	This field displays the etherStatsPkts.
etherStatsBroadcastPkts	This field displays the etherStatsBroadcastPkts.
etherStatsMulticastPkts	This field displays the etherStatsMulticastPkts.
etherStatsCRCAlignErrors	This field displays the etherStatsCRCAlignErrors.
etherStatsUnderSizePkts	This field displays the etherStatsUnderSizePkts.
etherStatsOverSizePkts	This field displays the etherStatsOverSizePkts.
etherStatsFragments	This field displays the etherStatsFragments.
etherStatsJabbers	This field displays the etherStatsJabbers.
etherStatsCollisions	This field displays the etherStatsCollisions.
etherStatsPkts64Octets	This field displays the etherStatsPkts64Octets.
etherStatsPkts65to127Octets	This field displays the etherStatsPkts65to127Octets.
etherStatsPkts128to255Octets	This field displays the etherStatsPkts128to255Octets.
etherStatsPkts256to511Octets	This field displays the etherStatsPkts256to511Octets.
etherStatsPkts512to1023Octets	This field displays the etherStatsPkts512to1023Octets.
etherStatsPkts1024to1518Octets	This field displays the etherStatsPkts1024to1518Octets.

### 8.2.3 Bandwidth Utilization

Utilization is the percentage of a network's bandwidth that is currently being consumed by network traffic. Each vertical bar represents the highest utilization on a port, and can be either transmitted (Tx) traffic or received (Rx) traffic during the last time interval in seconds.

Use this screen to view the Switch's bandwidth utilization settings. Click **Monitor > Port > Port > Bandwidth Utilization** to access this screen.



Figure 92 Monitor &gt; Port &gt; Port &gt; Bandwidth Utilization



Each field is described in the following table.

Table 32 Monitor &gt; Port &gt; Port &gt; Bandwidth Utilization

LABEL	DESCRIPTION
Bandwidth Utilization	
1Gbps	This field displays the 1 Gbps.
100Mbps	This field displays the 100 Mbps.
10Mbps	This field displays the 10 Mbps.
Link down	This field displays the link down.
Refresh period	This field displays the refresh period.
IFG	This field displays the IFG.
Tx	Transmitted (Tx) traffic during the last time interval in seconds.
Rx	Received (Rx) traffic during the time interval in seconds.

## 8.3 PoE Settings

Note: The PoE function and the following screens are available for models ending in "HP" only.

The Switch supports both the IEEE 802.3af Power over Ethernet (PoE) and IEEE 802.3at High Power over Ethernet (PoE) standards. The Switch is Power Sourcing Equipment (PSE) because it provides a source of power through its Ethernet ports, and each device that receives power through an Ethernet port is a

Powered Device (PD).

In the figure below, the IP camera and IP phone get their power directly from the Switch. Aside from minimizing the need for cables and wires, PoE removes the hassle of trying to find a nearby electric outlet to power up devices.

**Figure 93** Powered Device Examples

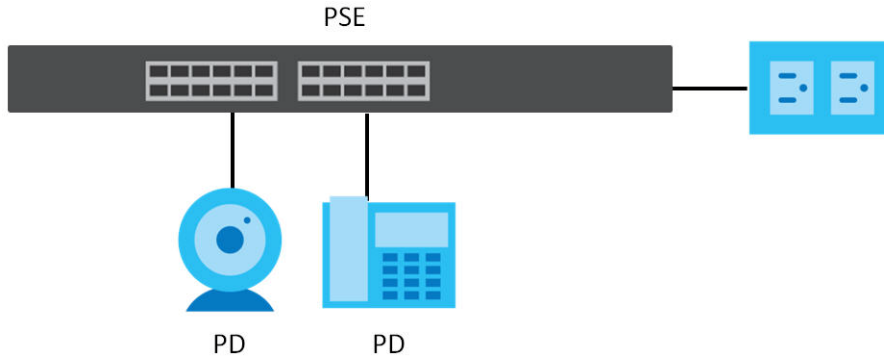

You can also set priorities so that the Switch is able to reserve and allocate power to certain PDs.

Note: The PoE devices that supply or receive power and their connected Ethernet cables must all be completely indoors.

To view the current amount of power that PDs are receiving from the Switch, click **Monitor > Port > PoE**.

**Figure 94** Monitor > Port > PoE

PoE				
PoE Mode	Total Power(W)	Consuming Power(W)	Allocated Power(W)	Remaining Power(W)
Consumption	170.0	0.0	0.0	170.0

Each field is described in the following table.

Table 33 Monitor > Port > PoE

LABEL	DESCRIPTION
PoE Mode	This field displays the power management mode used by the Switch, whether it is in <b>Classification</b> or <b>Consumption</b> mode.
Total Power(W)	This field displays the total power the Switch can provide to the connected PoE-enabled devices on the PoE ports. The total power of GS1900-10HP is 77 W and GS1900-8HP is 70 W.
Consuming Power(W)	This field displays the total amount of power the Switch is currently supplying to the connected PoE-enabled devices.
Allocated Power(W)	This field displays the total amount of power the Switch (in <b>Classification</b> mode) has reserved for PoE after negotiating with the connected PoE devices. It shows <b>NA</b> when the Switch is in <b>Consumption</b> mode. <b>Consuming Power (W)</b> can be less than or equal but not more than the <b>Allocated Power (W)</b> .
Remaining Power(W)	This field displays the amount of power the Switch can still provide for PoE. Note: The Switch must have at least 16 W of remaining power in order to supply power to a PoE device, even if the PoE device needs less than 16 W.

## 8.4 Bandwidth Management

This section shows you the maximum bandwidth using the **Bandwidth Management** screen. Bandwidth management shows the maximum allowable bandwidth for incoming and/or out-going traffic flows on a port.

### 8.4.1 Bandwidth Control

Use this screen to view the Switch's bandwidth control in egress global burst and port rate.

An egress port is an outgoing port, that is, a port through which a data packet leaves for both ports. An ingress port is an incoming port, that is, a port through which a data packet enters.

Click **Monitor > Port > Bandwidth Management > Bandwidth Control** to access this screen.

**Figure 95** Monitor > Port > Bandwidth Management > Bandwidth Control

Bandwidth Control		
Egress Global Burst	40000(Byte)	
<b>Port Rate</b>		
Port	Ingress RateLimit (Kbps)	Egress RateLimit (Kbps)
1	Disable	Disable
2	Disable	Disable
3	Disable	Disable
4	Disable	Disable
5	Disable	Disable
6	Disable	Disable
7	Disable	Disable
8	Disable	Disable
9	Disable	Disable
10	Disable	Disable
11	Disable	Disable
22	Disable	Disable
23	Disable	Disable
24	Disable	Disable
25	Disable	Disable
26	Disable	Disable

Each field is described in the following table.

**Table 34** Monitor > Port > Bandwidth Management > Bandwidth Control

LABEL	DESCRIPTION
Bandwidth Control	
Egress Global Burst	This field specifies the current egress burst size in bytes all ports.
Port Rate	View the maximum bandwidth allowed in kilobits per second (Kbps) for the traffic flow on a port.
Port	This field displays the port number.

Table 34 Monitor &gt; Port &gt; Bandwidth Management &gt; Bandwidth Control (continued)

LABEL	DESCRIPTION
Ingress RateLimit (Kbps)	View the maximum bandwidth allowed in kilobits per second (Kbps) for the incoming traffic flow on a port.
Egress RateLimit (Kbps)	View the maximum bandwidth allowed in kilobits per second (Kbps) for the out-going traffic flow on a port.

## 8.5 Storm Control

This section shows you the storm control feature.

Storm control limits the number of broadcast, multicast and unicast packets the Switch receives per second on the ports. When the maximum number of allowable broadcast, multicast and/or unicast packets is reached per second, the subsequent packets are discarded. Enabling this feature reduces broadcast, multicast and/or unicast packets in your network. You can specify limits for each packet type on each port.

Click **Monitor > Port > Storm Control** to access this screen.

Figure 96 Monitor &gt; Port &gt; Storm Control

Storm Control					
Port	State	Broadcast (pps)	Unknown Multicast (pps)	Unknown Unicast (pps)	Action
1	Disable	Disable	Disable	Disable	Drop
2	Disable	Disable	Disable	Disable	Drop
3	Disable	Disable	Disable	Disable	Drop
4	Disable	Disable	Disable	Disable	Drop
5	Disable	Disable	Disable	Disable	Drop
6	Disable	Disable	Disable	Disable	Drop
7	Disable	Disable	Disable	Disable	Drop
8	Disable	Disable	Disable	Disable	Drop
9	Disable	Disable	Disable	Disable	Drop
10	Disable	Disable	Disable	Disable	Drop
11	Disable	Disable	Disable	Disable	Drop
12	Disable	Disable	Disable	Disable	Drop
13	Disable	Disable	Disable	Disable	Drop
14	Disable	Disable	Disable	Disable	Drop
15	Disable	Disable	Disable	Disable	Drop
16	Disable	Disable	Disable	Disable	Drop
17	Disable	Disable	Disable	Disable	Drop
18	Disable	Disable	Disable	Disable	Drop
19	Disable	Disable	Disable	Disable	Drop
20	Disable	Disable	Disable	Disable	Drop
21	Disable	Disable	Disable	Disable	Drop
22	Disable	Disable	Disable	Disable	Drop
23	Disable	Disable	Disable	Disable	Drop
24	Disable	Disable	Disable	Disable	Drop
25	Disable	Disable	Disable	Disable	Drop
26	Disable	Disable	Disable	Disable	Drop

Each field is described in the following table.

Table 35 Monitor > Port > Storm Control

LABEL	DESCRIPTION
Storm Control	
Port	This field displays the port number.
State	This field displays the state.
Broadcast (pps)	Displays how many broadcast packets the port receives (in pps).
Unknown Multicast (pps)	Displays how many unknown multicast packets the port receives (in pps).
Unknown Unicast (pps)	Displays how many unknown unicast packets the port receives (in pps).
Action	Displays the action the device takes when a limit is reached. The following options are available: <ul style="list-style-type: none"><li>• <b>Drop</b> – drop the packet.</li><li>• <b>Shutdown</b> – shutdown the connection.</li></ul>

# CHAPTER 9

## Monitor: VLAN

### 9.1 Overview

This section provides information for **VLAN** in **Monitor**.

A VLAN (Virtual Local Area Network) allows a physical network to be partitioned into multiple logical networks. Devices on a logical network belong to one group. A device can belong to more than one group. With VLAN, a device cannot directly talk to or hear from devices that are not in the same groups; the traffic must first go through a router.

In MTU (Multi-Tenant Unit) applications, VLAN is vital in providing isolation and security among the subscribers. When properly configured, VLAN prevents one subscriber from accessing the network resources of another on the same LAN, therefore a user will not see the printers and hard disks of another user on the same network.

VLAN also increases network performance by limiting broadcasts to a smaller and more manageable logical broadcast domain. In traditional switched environments, all broadcast packets go to each and every individual port. With VLAN, all broadcasts are confined to a specific broadcast domain.

#### 9.1.1 What You Can Do in this Chapter

- The **VLAN** screen ([Section 9.2 on page 86](#)) displays VLAN, port, and VLAN port settings.
- The **Guest VLAN** screen ([Section 9.3 on page 89](#)) displays the global and port settings of the Switch.
- The **Voice VLAN** screen ([Section 9.4 on page 90](#)) displays the global and port settings of the Switch.

### 9.2 VLAN Settings

Use this screen to view Switch VLAN settings.

#### 9.2.1 VLAN

Use this screen to view the Switch's VLAN settings. Click **Monitor** > **VLAN** > **VLAN** > **VLAN** to access this screen.

**Figure 97** Monitor > VLAN > VLAN > VLAN

VLAN		<a href="#">VLAN</a>	<a href="#">Port</a>	<a href="#">VLAN Port</a>
VLAN ID	VLAN Name	VLAN Type		
1	default	Default		

Each field is described in the following table.

Table 36 Monitor &gt; VLAN &gt; VLAN &gt; VLAN

LABEL	DESCRIPTION
VLAN	
VLAN ID	This is the VLAN identification number.
VLAN Name	Displays a descriptive name for the VLAN for identification purposes.
VLAN Type	Displays a type for the VLAN for identification purposes.

## 9.2.2 Port

Use this screen to view the Switch's port setting in VLAN. Click **Monitor > VLAN > VLAN > Port** to access this screen.

Figure 98 Monitor &gt; VLAN &gt; VLAN &gt; Port

Port		VLAN	Port	VLAN Port
Port	PVID	Accept Frame Type	Ingress Check	VLAN Trunk
1	1	ALL	Disable	Disable
2	1	ALL	Disable	Disable
3	1	ALL	Disable	Disable
4	1	ALL	Disable	Disable
5	1	ALL	Disable	Disable
6	1	ALL	Disable	Disable
7	1	ALL	Disable	Disable
8	1	ALL	Disable	Disable
9	1	ALL	Disable	Disable
10	1	ALL	Disable	Disable
11	1	ALL	Disable	Disable
12	1	ALL	Disable	Disable
13	1	ALL	Disable	Disable
14	1	ALL	Disable	Disable
15	1	ALL	Disable	Disable
16	1	ALL	Disable	Disable
17	1	ALL	Disable	Disable
18	1	ALL	Disable	Disable
19	1	ALL	Disable	Disable
20	1	ALL	Disable	Disable
21	1	ALL	Disable	Disable
22	1	ALL	Disable	Disable
23	1	ALL	Disable	Disable
24	1	ALL	Disable	Disable
25	1	ALL	Disable	Disable
26	1	ALL	Disable	Disable
LAG1	1	ALL	Disable	Disable
LAG2	1	ALL	Disable	Disable
LAG3	1	ALL	Disable	Disable
LAG4	1	ALL	Disable	Disable
LAG5	1	ALL	Disable	Disable
LAG6	1	ALL	Disable	Disable
LAG7	1	ALL	Disable	Disable
LAG8	1	ALL	Disable	Disable

Each field is described in the following table.

Table 37 Monitor &gt; VLAN &gt; VLAN &gt; Port

LABEL	DESCRIPTION
Port	
Port	This field displays the port number.
PVID	This is the port VLAN identification number.  A PVID (Port VLAN ID) is a tag that adds to incoming untagged frames received on a port so that the frames are forwarded to the VLAN group that the tag defines.

Table 37 Monitor &gt; VLAN &gt; VLAN &gt; Port (continued)

LABEL	DESCRIPTION
Accept Frame Type	This field displays the type that is accepted by the frame. Specifies the type of frames allowed on a port. Choices are <b>All</b> , <b>Tag Only</b> and <b>Untag Only</b> . <b>All</b> accepts all untagged or tagged frames on this port. This is the default setting. <b>Tag Only</b> accepts only tagged frames on this port. All untagged frames will be dropped. <b>Untag Only</b> accepts only untagged frames on this port. All tagged frames will be dropped.
Ingress Filter	If set, the Switch discards incoming frames for VLANs that do not have this port as a member.
VLAN Trunks	Enable <b>VLAN Trunking</b> on ports connected to other switches or routers (but not ports directly connected to end users) to allow frames belonging to unknown VLAN groups to pass through the Switch.

### 9.2.3 VLAN Port

Port-based VLANs are VLANs where the packet forwarding decision is based on the destination MAC address and its associated port. Port-based VLANs require allowed outgoing ports to be defined for each port. Therefore, if you wish to allow two subscriber ports to talk to each other, for example, between conference rooms in a hotel, you must define the egress (an egress port is an outgoing port, that is, a port through which a data packet leaves) for both ports. Port-based VLANs are specific only to the Switch on which they were created.

Use this screen to view the Switch's VLAN port settings. Click **Monitor > VLAN > VLAN > VLAN Port** to access this screen.

Figure 99 Monitor &gt; VLAN &gt; VLAN &gt; VLAN Port

Port	Membership
1	Untagged
2	Untagged
3	Untagged
4	Untagged
5	Untagged
6	Untagged
7	Untagged
8	Untagged
9	Untagged
10	Untagged
11	Untagged
12	Untagged
13	Untagged
14	Untagged
15	Untagged
16	Untagged
17	Untagged
18	Untagged
19	Untagged
20	Untagged
21	Untagged
22	Untagged
23	Untagged
24	Untagged
25	Untagged
26	Untagged
LAG1	Untagged
LAG2	Untagged
LAG3	Untagged
LAG4	Untagged
LAG5	Untagged
LAG6	Untagged
LAG7	Untagged
LAG8	Untagged



Each field is described in the following table.

Table 38 Monitor > VLAN > VLAN > VLAN Port

LABEL	DESCRIPTION
VLAN Port	
VLAN ID	This is the VLAN identification number.
Port	Displays the port index value.
Membership	Displays the status of the VLAN group: <b>Forbidden</b> , <b>Excluded</b> , <b>Tagged</b> or <b>Untagged</b> .

## 9.3 Guest VLAN

When 802.1x port authentication is enabled on the Switch and its ports, clients that do not have the correct credentials are blocked from using the ports. You can configure your Switch to have one VLAN that acts as a guest VLAN. If you enable the guest VLAN (**102** in the example) on a port (**2** in the example), the user (**A** in the example) that is not IEEE 802.1x capable or fails to enter the correct user name and password can still access the port, but traffic from the user is forwarded to the guest VLAN. That is, unauthenticated users can have access to limited network resources in the same guest VLAN, such as the Internet. The rights granted to the Guest VLAN depends on how the network administrator configures switches or routers with the guest network feature.

Figure 100 Guest VLAN Example

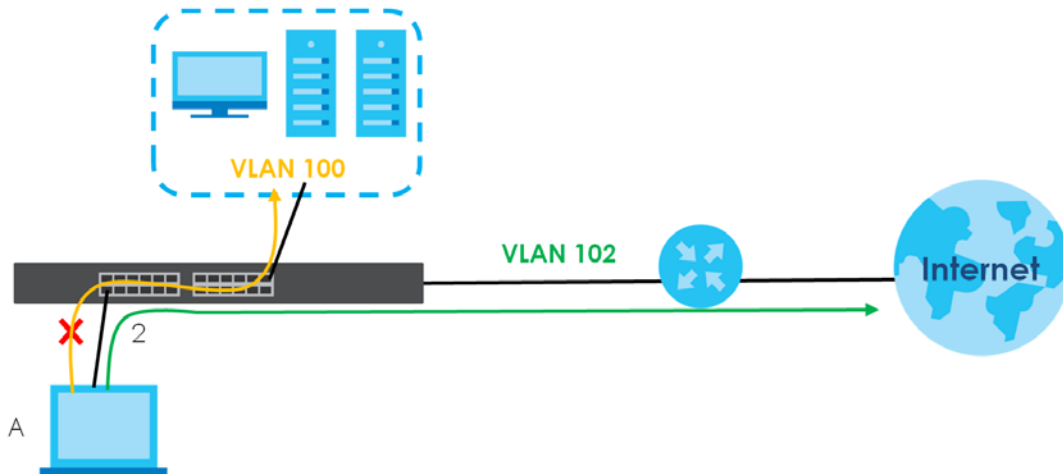

Use this screen to view the Switch's guest VLAN. Click **Monitor > VLAN > Guest VLAN** to access this screen.

Figure 101 Monitor &gt; VLAN &gt; Guest VLAN

Guest VLAN		
State	Disable	
<b>Port</b>		
Port	State	In Guest VLAN
1	Disable	No
2	Disable	No
3	Disable	No
4	Disable	No
5	Disable	No
6	Disable	No
7	Disable	No
8	Disable	No
9	Disable	No
10	Disable	No
11	Disable	No
12	Disable	No
13	Disable	No
14	Disable	No
15	Disable	No
16	Disable	No
17	Disable	No
18	Disable	No
19	Disable	No
20	Disable	No
21	Disable	No
22	Disable	No
23	Disable	No
24	Disable	No
25	Disable	No
26	Disable	No

Each field is described in the following table.

Table 39 Monitor &gt; VLAN &gt; Guest VLAN

LABEL	DESCRIPTION
Guest VLAN	
State	This field displays the state of global guest VLAN.
Port	
Port	This field displays a port number.
State	This field displays the state of a port.
In Guest VLAN	This field displays the status of the port, is the port is in guest VLAN or not.

## 9.4 Voice VLAN

Voice VLANs are VLANs configured specially for voice traffic. By adding the ports connected with voice devices to voice VLANs, you can have voice traffic transmitted within voice VLANs and perform QoS-related configuration for voice traffic as required, therefore ensuring the transmission priority of voice traffic and voice quality.

Use this screen to view Switch global and port voice VLAN settings for voice traffic. Click **Monitor > VLAN > Voice VLAN** to access this screen.

Figure 102 Monitor &gt; VLAN &gt; Voice VLAN

Voice VLAN	
State	Disable
Voice VLAN ID	none (disable)
Cos/802.1p	5
Remark Cos/802.1p	Disable
Aging Time (30-65536 min)	1440
<b>Port</b>	
Port	State
1	Disable
2	Disable
3	Disable
4	Disable
5	Disable
6	Disable
7	Disable
8	Disable
9	Disable
10	Disable
11	Disable
12	Disable
13	Disable
14	Disable
15	Disable
16	Disable
17	Disable
18	Disable
19	Disable
20	Disable
21	Disable
22	Disable
23	Disable
24	Disable
25	Disable
26	Disable

Each field is described in the following table.

Table 40 Monitor &gt; VLAN &gt; Voice VLAN

LABEL	DESCRIPTION
Voice VLAN	
State	This field displays the state of a port.
Voice VLAN ID	This is the voice VLAN identification number.
Cos/802.1p	This displays the packet's 802.1p priority field.
Remark Cos/802.1p	This field displays the state of the cos/802.1p.
Aging Time (30-65536 min)	Displays the time interval (from 30 to 65536) in minutes.
Port	
Port	This field displays a port number.
State	This field displays the state of a port.

# CHAPTER 10

## Monitor: MAC Table

### 10.1 Overview

This section provides information for **MAC Table** in **Monitor**.

The **MAC Table** screen (a MAC table is also known as a filtering database) shows how frames are forwarded or filtered across the Switch's ports. When a device (which may belong to a VLAN group) sends a packet which is forwarded to a port on the Switch, the MAC address of the device is shown on the Switch's **MAC Table**. It also shows whether the MAC address is dynamic (learned by the Switch) or static (manually entered in the **Static MAC Forwarding** screen).

The Switch uses the **MAC Table** to determine how to forward frames. See the following figure.

- 1 The Switch examines a received frame and learns the port from which this source MAC address came.
- 2 The Switch checks to see if the frame's destination MAC address matches a source MAC address already learned in the **MAC Table**.
  - If the Switch has already learned the port for this MAC address, then it forwards the frame to that port.
  - If the Switch has not already learned the port for this MAC address, then the frame is flooded to all ports. Too much port flooding leads to network congestion.
  - If the Switch has already learned the port for this MAC address, but the destination port is the same as the port it came in on, then it filters the frame.

**Figure 103** MAC Table Flowchart

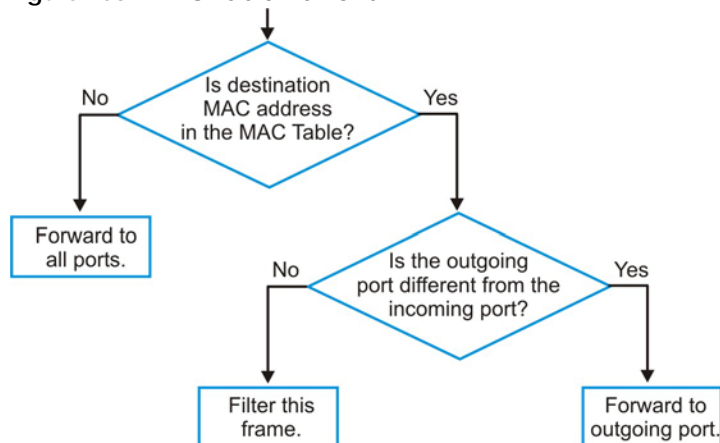

This link takes you to a screen where you can view the MAC address and VLAN ID of a device attach to a port. You can also view what kind of MAC address it is.

## 10.1.1 What You Can Do in this Chapter

The **MAC Table** screen (Section 10.2 on page 93) displays view filter and MAC table of the Switch.

## 10.2 MAC Table

Use this screen to view filter static and MAC table settings. Click **Monitor > MAC Table** to access this screen.

**Figure 104** Monitor > MAC Table

MAC Address	VLAN	Type	Port
10:BF:48:D5:AB:72	default(1)	Dynamic	24
20:6A:8A:00:F2:57	default(1)	Dynamic	24
20:6A:8A:39:FB:38	default(1)	Dynamic	24
3C:97:0E:63:AF:24	default(1)	Dynamic	24
4C:9E:FF:72:4A:87	default(1)	Static Unicast	CPU
74:27:EA:2B:FA:AA	default(1)	Dynamic	24
90:2B:34:BB:7A:A4	default(1)	Dynamic	24
B8:EC:A3:0F:CF:9F	default(1)	Dynamic	24
C0:3F:D5:F9:9A:48	default(1)	Dynamic	24
C0:3F:D5:F9:BA:0A	default(1)	Dynamic	24
DC:4A:3E:40:EC:5F	default(1)	Dynamic	24
DC:4A:3E:40:EC:67	default(1)	Dynamic	12
E4:18:6B:F7:BA:79	default(1)	Dynamic	24
E4:18:6B:F7:BA:8B	default(1)	Dynamic	24

Total Entries: 14

Each field is described in the following table.

Table 41 Monitor > MAC Table

LABEL	DESCRIPTION
MAC Table	
MAC Address	This is the MAC address of the device from which this incoming frame came.
VLAN	Displays a type for the VLAN for identification purposes.
Port	This is the port from which the above MAC address was learned.
View	This link takes you to a screen where you can view the MAC address and VLAN ID of a device attach to a port. You can also view what kind of MAC address it is.
Clear	Click <b>Clear</b> to return the fields to the factory defaults.
MAC Address	This is the MAC address of the device from which this incoming frame came.
VLAN	Displays a type for the VLAN for identification purposes.

Table 41 Monitor &gt; MAC Table (continued)

LABEL	DESCRIPTION
Type	This shows whether the MAC address is <b>dynamic</b> (learned by the Switch) or <b>static</b> (manually entered in the <b>Static MAC Forwarding</b> screen).
Port	This is the port from which the above MAC address was learned.
Total Entries	Displays the number of total entries.

# CHAPTER 11

## Monitor: Link Aggregation

### 11.1 Overview

This section provides information for **Link Aggregation** in **Monitor**.

Link aggregation (trunking) is the grouping of physical ports into one logical higher-capacity link. You may want to trunk ports if for example, it is cheaper to use multiple lower-speed links than to under-utilize a high-speed, but more costly, single-port link. However, the more ports you aggregate then the fewer available ports you have. A trunk group is one logical link containing multiple ports.

The Switch supports both static and dynamic link aggregation.

Note: In a properly planned network, it is recommended to implement static link aggregation only. This ensures increased network stability and control over the trunk groups on your Switch.

#### 11.1.1 What You Can Do in this Chapter

The **Link Aggregation** screen ([Section 11.2 on page 95](#)) displays link aggregation status.

### 11.2 Link Aggregation

Use the **Link Aggregation** screens to view Switch link aggregation status. Click **Monitor > Link Aggregation** to access this screen.

**Figure 105** Monitor > Link Aggregation

Link Aggregation					
LAG	Name	Type	Link Status	Active Member	Standby Member
LAG1		---	Not Present	---	---
LAG2		---	Not Present	---	---
LAG3		---	Not Present	---	---
LAG4		---	Not Present	---	---
LAG5		---	Not Present	---	---
LAG6		---	Not Present	---	---
LAG7		---	Not Present	---	---
LAG8		---	Not Present	---	---

Each field is described in the following table.

Table 42 Monitor > Link Aggregation

<b>LABEL</b>	<b>DESCRIPTION</b>
LAG	Displays the link aggregation status index value.
Name	This field displays the name.
Type	This field displays the type.
Link Status	This field displays the status of the link. It displays <b>Up</b> when the port is linked up or <b>Down</b> when it is not. When no any physical port is binding with this group, it displays <b>NotPresent</b> .
Active Member	Displays if this member is an active member of a trunk.
Standby Member	Displays if this member is an standby member of a trunk.



# CHAPTER 12

## Monitor: Loop Guard

### 12.1 Overview

This section provides information for **Loop Guard in Monitor**.

Loop guard is designed to handle loop problems on the edge of your network. This can occur when a port is connected to a Switch that is in a loop state. Loop state occurs as a result of human error. It happens when two ports on a switch are connected with the same cable. When a switch in loop state sends out broadcast messages the messages loop back to the switch and are re-broadcast again and again causing a broadcast storm.

If a switch (not in loop state) connects to a switch in loop state, then it will be affected by the switch in loop state in the following way:

- It will receive broadcast messages sent out from the switch in loop state.
- It will receive its own broadcast messages that it sends out as they loop back. It will then re-broadcast those messages again.

The following figure shows port **N** on switch **A** connected to switch **B**. Switch **B** is in loop state. When broadcast or multicast packets leave port **N** and reach switch **B**, they are sent back to port **N** on **A** as they are rebroadcast from **B**.

**Figure 106** Switch in Loop State

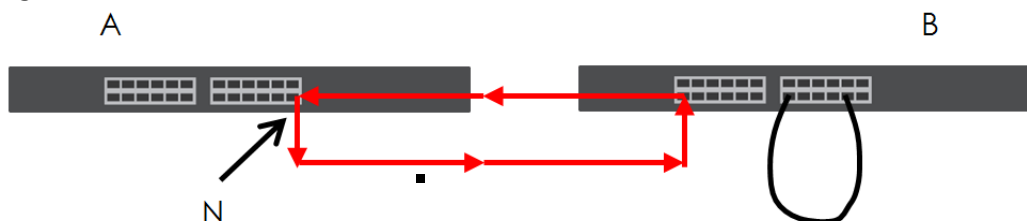

The loop guard feature checks to see if a loop guard enabled port is connected to a switch in loop state. This is accomplished by periodically sending a probe packet and seeing if the packet returns on the same port. If this is the case, the Switch will shut down the port connected to the switch in loop state.

The following figure shows a loop guard enabled port **N** on switch **A** sending a probe packet **P** to switch **B**. Since switch **B** is in loop state, the probe packet **P** returns to port **N** on **A**. The Switch then shuts down port **N** to ensure that the rest of the network is not affected by the switch in loop state.

Figure 107 Loop Guard – Probe Packet

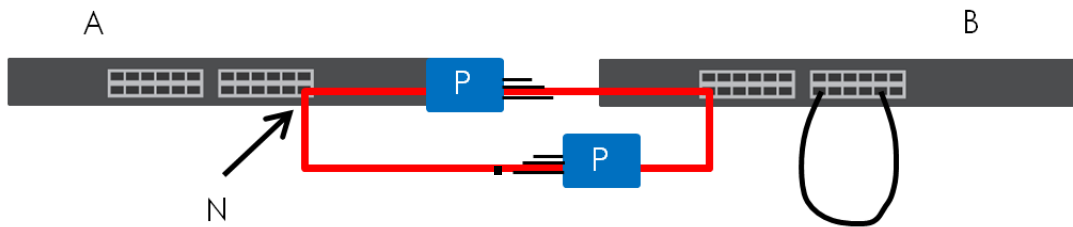

The Switch also shuts down port **N** if the probe packet returns to switch **A** on any other port. In other words loop guard also protects against standard network loops. The following figure illustrates three switches forming a loop. A sample path of the loop guard probe packet is also shown. In this example, the probe packet is sent from port **N** and returns on another port. As long as loop guard is enabled on port **N**, the Switch will shut down port **N** if it detects that the probe packet has returned to the Switch.

Figure 108 Loop Guard – Network Loop

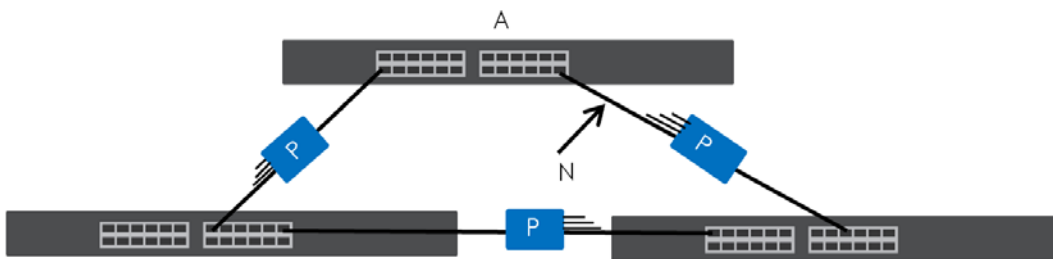

## 12.1.1 What You Can Do in this Chapter

The **Loop Guard** screen ([Section 12.2 on page 98](#)) displays loop guard status.

## 12.2 Loop Guard

Use the **Loop Guard** screen to view Switch loop guard status. Click **Monitor > Loop Guard** to access this screen.

Figure 109 Monitor &gt; Loop Guard

Loop Guard			
Port	Status	Time Left (sec)	Action
1	No Loop	---	Recovery
2	No Loop	---	Recovery
3	No Loop	---	Recovery
4	No Loop	---	Recovery
5	No Loop	---	Recovery
6	No Loop	---	Recovery
7	No Loop	---	Recovery
8	No Loop	---	Recovery
9	No Loop	---	Recovery
10	No Loop	---	Recovery
11	No Loop	---	Recovery
12	No Loop	---	Recovery
13	No Loop	---	Recovery
14	No Loop	---	Recovery
15	No Loop	---	Recovery
16	No Loop	---	Recovery
17	No Loop	---	Recovery
18	No Loop	---	Recovery
19	No Loop	---	Recovery
20	No Loop	---	Recovery
21	No Loop	---	Recovery
22	No Loop	---	Recovery
23	No Loop	---	Recovery
24	No Loop	---	Recovery
25	No Loop	---	Recovery
26	No Loop	---	Recovery

Each field is described in the following table.

Table 43 Monitor &gt; Loop Guard

LABEL	DESCRIPTION
Loop Guard	
Port	This field displays a port number.
Status	This field displays the status.
Time Left (sec)	This field displays the amount of time left in seconds.
Action	This field displays the action.

# CHAPTER 13

## Monitor: Multicast

### 13.1 Overview

This section provides information for **Multicast** in **Monitor**.

Traditionally, IP packets are transmitted in one of either two ways – Unicast (1 sender to 1 recipient) or Broadcast (1 sender to everybody on the network). Multicast delivers IP packets to just a group of hosts on the network.

IGMP (Internet Group Management Protocol) is a network-layer protocol used to establish membership in an IPv4 multicast group – it is not used to carry user data. Refer to RFC 1112, RFC 2236 and RFC 3376 for information on IGMP versions 1, 2 and 3 respectively.

#### 13.1.1 What You Can Do in this Chapter

The **IGMP** screen ([Section 13.2 on page 100](#)) displays VLAN, statistics, group, and router.

### 13.2 IGMP Settings

Use this screen to view Switch various multicast features.

#### 13.2.1 VLAN

Use this screen to view the Switch's IGMP VLAN. Click **Monitor > Multicast > IGMP > VLAN** to access this screen.

**Figure 110** Monitor > Multicast > IGMP > VLAN

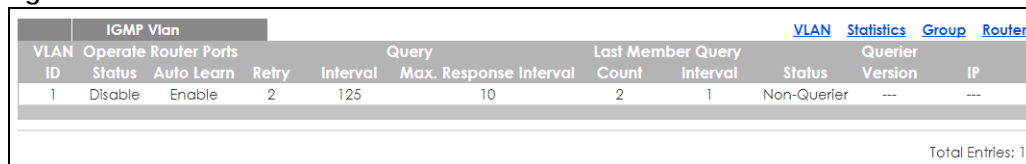

IGMP Vlan											<a href="#">VLAN</a>	<a href="#">Statistics</a>	<a href="#">Group</a>	<a href="#">Router</a>						
VLAN ID	Operate Status	Router Ports	Query	Last Member Query	Querier	Status	Version	IP	Count	Interval	Interval	Max. Response Interval	Interval	Interval	Interval	Interval	Interval	Interval	Interval	Interval
1	Disable	Enable	2	125	10	2	1	Non-Querier	---	---	---	---	---	---	---	---	---	---	---	---

Total Entries: 1

Each field is described in the following table.

Table 44 Monitor > Multicast > IGMP > VLAN

LABEL	DESCRIPTION
IGMP Vlan	
VLAN ID	Displays the identification for the VLAN.
Operate Status	Displays the status of the operation.

Table 44 Monitor > Multicast > IGMP > VLAN (continued)

LABEL	DESCRIPTION
Router Ports Auto Learn	Displays whether the router ports are auto learn or not.
Query	
Retry	Displays the number of retry.
Interval	Displays the number (in seconds) for the time interval.
Max. Response Interval (sec)	Displays the maximum response (in seconds) for the time interval.
Last Member Query	
Count	Displays the number of count.
Interval (sec)	Displays the in seconds for the time interval.
Querier	Allows the Switch to send IGMP General Query messages to the VLANs with the multicast hosts attached.
Status	This field displays the entry as querier or non-querier.
Version	This field displays the entry querier version.
IP	This field displays the entry querier IP address.
Total Entries	This field displays the number of total entries.

### 13.2.2 Statistics

Use this screen to view the Switch's IGMP statistics. Click **Monitor > Multicast > IGMP > Statistics** to access this screen.

Figure 111 Monitor > Multicast > IGMP > Statistics

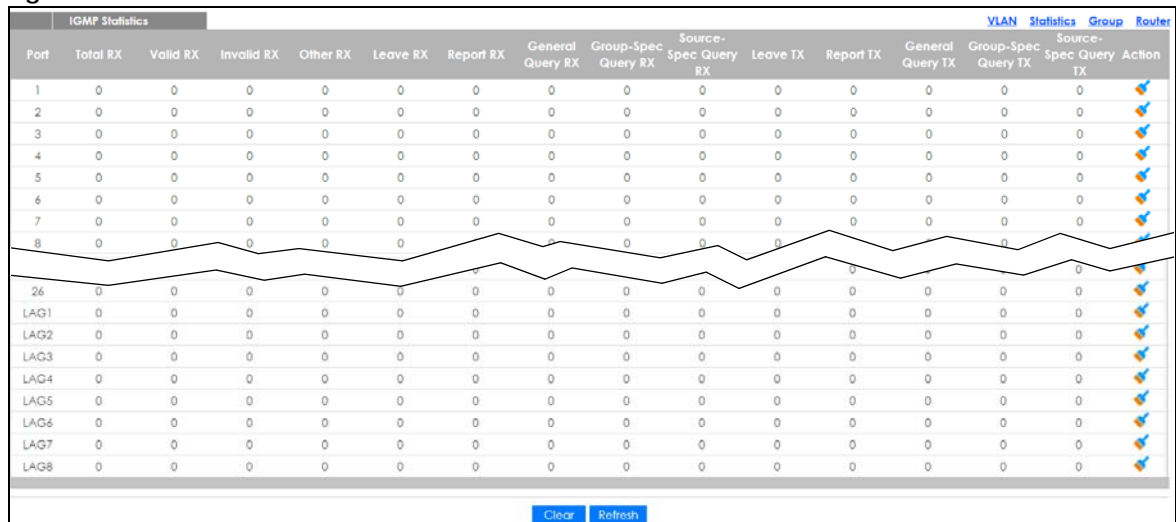

Each field is described in the following table.

Table 45 Monitor > Multicast > IGMP > Statistics

LABEL	DESCRIPTION
IGMP Statistics	
Port	This field displays a port number.
Total RX	This field displays the total amount of RX.

Table 45 Monitor &gt; Multicast &gt; IGMP &gt; Statistics (continued)

LABEL	DESCRIPTION
Valid RX	This field displays the total amount of valid RX.
Invalid RX	This field displays the total amount of invalid RX.
Other RX	This field displays the total amount of other RX.
Leave RX	This field displays the total amount of leave RX.
Report RX	This field displays the total amount of report RX.
General Query RX	This field displays the total amount of general query RX.
Group-Spec Query RX	This field displays the total amount of group-spec query RX.
Source-Spec Query RX	This field displays the total amount of source-spec query RX.
Leave TX	This field displays the total amount of leave TX.
Report TX	This field displays the total amount of report TX.
General Query TX	This field displays the total amount of general query TX.
Group-Spec Query TX	This field displays the total amount of group-spec query TX.
Source-Spec Query TX	This field displays the total amount of source-spec query TX.
Action	Click <b>Action</b> to reset the statistics of the specific field back to zero.
Clear	Click <b>Clear</b> to clear statistics on this port.
Clear	Click <b>Clear</b> to reset the fields to the factory defaults.
Refresh	Click <b>Refresh</b> to reload the page.

In the Action column, the **Action** option allows you to clear the statistics.

Click **OK** and confirm at the pop-up screen to complete the task. Click **Cancel** and confirm at the pop-up screen to discard the changes.

Figure 112 Monitor &gt; Multicast &gt; IGMP &gt; Statistics &gt; Action

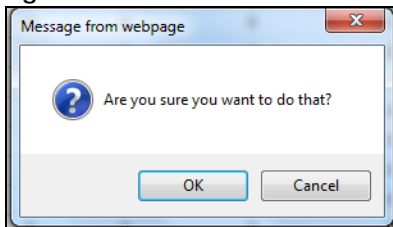

### 13.2.3 Group

Use this screen to view the Switch's IGMP group. Click **Monitor > Multicast > IGMP > Group** to access this screen.

Figure 113 Monitor &gt; Multicast &gt; IGMP &gt; Group

IGMP Group				<a href="#">VLAN</a>	<a href="#">Statistics</a>	<a href="#">Group</a>	<a href="#">Router</a>
VLAN ID	Group IP Address	Member Ports	Life(sec)				
							Total Entries: 0
							<a href="#">Clear</a> <a href="#">Refresh</a>

Each field is described in the following table.

Table 46 Monitor &gt; Multicast &gt; IGMP &gt; Group

LABEL	DESCRIPTION
IGMP Group	
VLAN ID	Displays the identification for the VLAN.
Group IP Address	This field displays the group IP address.
Member Ports	This field displays the member ports.
Life(sec)	Displays life in seconds for the time interval.
Total Entries	This field displays the number of total entries.
Clear	Click <b>Clear</b> to delete the dynamic groups.
Refresh	Click <b>Refresh</b> to reload the page.

## 13.2.4 Router

Use this screen to view the Switch's IGMP router. Click **Monitor > Multicast > IGMP > Router** to access this screen.

Figure 114 Monitor &gt; Multicast &gt; IGMP &gt; Router

IGMP Router			
VLAN ID	Dynamic Router Ports	Static Router Ports	Forbidden Router Ports
Total Entries: 0			

Each field is described in the following table.

Table 47 Monitor &gt; Multicast &gt; IGMP &gt; Router

LABEL	DESCRIPTION
IGMP Router	
VLAN ID	Displays the identification for the VLAN.
Dynamic Router Ports	This field displays the dynamic router ports.
Static Router Ports	This field displays the static router ports.
Forbidden Router Ports	This field displays the forbidden router ports.
Total Entries	This field displays the number of total entries.

# CHAPTER 14

## Monitor: Spanning Tree

### 14.1 Overview

This section provides information for **Spanning Tree** in **Monitor**.

The Switch supports Spanning Tree Protocol (STP), Common and Internal Spanning Tree (CIST), and Multiple Spanning Tree (MST).

#### 14.1.1 What You Can Do in this Chapter

The **Spanning Tree** screen ([Section 14.2 on page 104](#)) displays CIST, CIST port, MST, MST port, STP statistics.

### 14.2 Spanning Tree

Use this screen to view Switch spanning tree settings.

#### 14.2.1 CIST Settings

Use this screen to view the Switch's spanning tree CIST instance. Click **Monitor** > **Spanning Tree** > **CIST** to access this screen.

**Figure 115** Monitor > Spanning Tree > CIST

CIST Instance		<a href="#">CIST</a>	<a href="#">CIST Port</a>	<a href="#">MST</a>	<a href="#">MST Port</a>	<a href="#">STP Statistics</a>
State	Disable					
Bridge Identifier	32768/ 0/4C:9E:FF:72:4A:87					
Designated Root Bridge	0/ 0/00:00:00:00:00:00					
External Root Path Cost	0					
Regional Root Bridge	0/ 0/00:00:00:00:00:00					
Internal Root Path Cost	0					
Designated Bridge	0/ 0/00:00:00:00:00:00					
Root Port	0/0					
Remaining Hops	0					
Last Topology Change	0					

Each field is described in the following table.

**Table 48** Monitor > Spanning Tree > CIST

LABEL	DESCRIPTION
CIST Instance	
State	This field displays the state.



Table 48 Monitor > Spanning Tree > CIST (continued)

LABEL	DESCRIPTION
Bridge Identifier	This is the unique identifier for this bridge, consisting of the bridge priority plus the MAC address.
Designated Root Bridge	Root bridge refers to the base of the spanning tree.
External Root Path Cost	The cost of the path from this bridge to the CIST Root Bridge.
Regional Root Bridge	Root bridge refers to the base of the spanning tree.
Internal Root Path Cost	The cost of the path from this bridge to the internal Regional Root Bridge.
Designated Bridge	For each LAN segment, a designated bridge is selected. This bridge has the lowest cost to the root among the bridges connected to the LAN.
Root Port	On each bridge, the bridge communicates with the root through the root port. The root port is the port on this Switch with the lowest path cost to the root (the root path cost). If there is no root port, then this Switch has been accepted as the root bridge of the spanning tree network.
Remaining Hops	This field displays the number of remaining hops.
Last Topology Change	Topology change information is directly propagated throughout the network from the device that generates the topology change.

## 14.2.2 CIST Port

Use this screen to view the Switch's spanning tree CIST port status. Click **Monitor > Spanning Tree > CIST Port** to access this screen.

Figure 116 Monitor > Spanning Tree > CIST Port

CIST Port										CIST	CIST Port	RST	RST Port	STP State
Port	Identifier (Priority / Port Id)	External Path Cost Operation	Internal Path Cost Operation	Designated Root Bridge	External Root Cost	Regional Root Bridge	Internal Root Cost	Designated Bridge	Edge Port Operation	P2P MAC Operation	Port Role	Port State		
1	128 / 1	20000	20000	0 / 00:00:00:00:00:00	0	0 / 00:00:00:00:00:00	0	0 / 00:00:00:00:00:00	Yes	No	Disable	Disable		
2	128 / 2	20000	20000	0 / 00:00:00:00:00:00	0	0 / 00:00:00:00:00:00	0	0 / 00:00:00:00:00:00	Yes	No	Disable	Disable		
3	128 / 3	20000	20000	0 / 00:00:00:00:00:00	0	0 / 00:00:00:00:00:00	0	0 / 00:00:00:00:00:00	Yes	No	Disable	Disable		
4	128 / 4	20000	20000	0 / 00:00:00:00:00:00	0	0 / 00:00:00:00:00:00	0	0 / 00:00:00:00:00:00	Yes	No	Disable	Disable		
5	128 / 5	20000	20000	0 / 00:00:00:00:00:00	0	0 / 00:00:00:00:00:00	0	0 / 00:00:00:00:00:00	Yes	No	Disable	Disable		
6	128 / 6	20000	20000	0 / 00:00:00:00:00:00	0	0 / 00:00:00:00:00:00	0	0 / 00:00:00:00:00:00	Yes	No	Disable	Disable		
7	128 / 7	20000	20000	0 / 00:00:00:00:00:00	0	0 / 00:00:00:00:00:00	0	0 / 00:00:00:00:00:00	Yes	No	Disable	Disable		
8	128 / 8	20000	20000	0 / 00:00:00:00:00:00	0	0 / 00:00:00:00:00:00	0	0 / 00:00:00:00:00:00	Yes	No	Disable	Disable		
25	128 / 25	20000	20000	0 / 00:00:00:00:00:00	0	0 / 00:00:00:00:00:00	0	0 / 00:00:00:00:00:00	Yes	No	Disable	Disable		
26	128 / 26	20000	20000	0 / 00:00:00:00:00:00	0	0 / 00:00:00:00:00:00	0	0 / 00:00:00:00:00:00	Yes	No	Disable	Disable		
LAG1	128 / 27	20000	20000	0 / 00:00:00:00:00:00	0	0 / 00:00:00:00:00:00	0	0 / 00:00:00:00:00:00	Yes	No	Disable	Disable		
LAG2	128 / 28	20000	20000	0 / 00:00:00:00:00:00	0	0 / 00:00:00:00:00:00	0	0 / 00:00:00:00:00:00	Yes	No	Disable	Disable		
LAG3	128 / 29	20000	20000	0 / 00:00:00:00:00:00	0	0 / 00:00:00:00:00:00	0	0 / 00:00:00:00:00:00	Yes	No	Disable	Disable		
LAG4	128 / 30	20000	20000	0 / 00:00:00:00:00:00	0	0 / 00:00:00:00:00:00	0	0 / 00:00:00:00:00:00	Yes	No	Disable	Disable		
LAG5	128 / 31	20000	20000	0 / 00:00:00:00:00:00	0	0 / 00:00:00:00:00:00	0	0 / 00:00:00:00:00:00	Yes	No	Disable	Disable		
LAG6	128 / 32	20000	20000	0 / 00:00:00:00:00:00	0	0 / 00:00:00:00:00:00	0	0 / 00:00:00:00:00:00	Yes	No	Disable	Disable		
LAG7	128 / 33	20000	20000	0 / 00:00:00:00:00:00	0	0 / 00:00:00:00:00:00	0	0 / 00:00:00:00:00:00	Yes	No	Disable	Disable		
LAG8	128 / 34	20000	20000	0 / 00:00:00:00:00:00	0	0 / 00:00:00:00:00:00	0	0 / 00:00:00:00:00:00	Yes	No	Disable	Disable		

Each field is described in the following table.

Table 49 Monitor > Spanning Tree > CIST Port

LABEL	DESCRIPTION
Port	This field displays the port number.
Identifier (Priority / Port Id)	This field displays the identifier (in priority / port number).
External Path Cost Operation	Path cost is the cost of transmitting a frame on to a LAN through that port. It is recommended to assign this value according to the speed of the bridge. The slower the media, the higher the cost.

Table 49 Monitor &gt; Spanning Tree &gt; CIST Port (continued)

LABEL	DESCRIPTION
Internal Path Cost Operation	Path cost is the cost of transmitting a frame on to a LAN through that port. It is recommended to assign this value according to the speed of the bridge. The slower the media, the higher the cost.
Designated Root Bridge	Root bridge refers to the base of the spanning tree.
External Root Cost	This field displays the external root cost.
Regional Root Bridge	Root bridge refers to the base of the spanning tree.
Internal Root Cost	This field displays the internal root cost.
Designated Bridge	For each LAN segment, a designated bridge is selected. This bridge has the lowest cost to the root among the bridges connected to the LAN.
Edge Port Operation	An edge port changes its initial STP port state from blocking state to forwarding state immediately without going through listening and learning states right after the port is configured as an edge port or when its link status changes.
P2P MAC Operation	This field displays the state of the P2P MAC operation.
Port Role	This field displays the state of the port role.
Port State	This field displays the state of the port.

## 14.2.3 MST Settings

Use this screen to view the Switch's spanning tree MST instance. Click **Monitor > Spanning Tree > MST** to access this screen.

Figure 117 Monitor &gt; Spanning Tree &gt; MST

MST Instance	CIST	CIST Port	MST	MST Port	STP Statistics
MST ID	1				
State	Disable				
Regional Root Bridge	---/---				
Internal Root Cost	---				
Designated Bridge	--/--				
Root Port	---/---				
Remaining Hops	---/---				
Last Topology Change	---/---				

Each field is described in the following table.

Table 50 Monitor &gt; Spanning Tree &gt; MST

LABEL	DESCRIPTION
MST Instance	
MST ID	This is the unique identifier for this MST. Select a number from the drop-down menu to display results.
State	This field displays the state.
Regional Root Bridge	Root bridge refers to the base of the spanning tree.
Internal Root Cost	This field displays the internal root cost.
Designated Bridge	For each LAN segment, a designated bridge is selected. This bridge has the lowest cost to the root among the bridges connected to the LAN.

Table 50 Monitor &gt; Spanning Tree &gt; MST (continued)

LABEL	DESCRIPTION
Root Port	On each bridge, the bridge communicates with the root through the root port. The root port is the port on this Switch with the lowest path cost to the root (the root path cost). If there is no root port, then this Switch has been accepted as the root bridge of the spanning tree network.
Remaining Hops	This field displays the number of remaining hops.
Last Topology Change	Topology change information is directly propagated throughout the network from the device that generates the topology change.

## 14.2.4 MST Port

Use this screen to view the Switch's spanning tree MST port status. Click **Monitor > Spanning Tree > MST Port** to access this screen.

Figure 118 Monitor &gt; Spanning Tree &gt; MST Port

Port	MSTI ID	Identifier (Priority / Port Id)	Internal Path Cost(Operaton)	Regional Root Bridge	Internal Root Cost	Designated Bridge	Port Role	Port State
1	1	128/1	---	---/---	---	---/---	---	---
2	1	128/2	---	---/---	---	---/---	---	---
3	1	128/3	---	---/---	---	---/---	---	---
4	1	128/4	---	---/---	---	---/---	---	---
5	1	128/5	---	---/---	---	---/---	---	---
6	1	128/6	---	---/---	---	---/---	---	---
7	1	128/7	---	---/---	---	---/---	---	---
8	1	128/8	---	---/---	---	---/---	---	---
9	1	128/9	---	---/---	---	---/---	---	---
10	1	128/10	---	---/---	---	---/---	---	---
LAG1	1	128/11	---	---/---	---	---/---	---	---
LAG2	1	128/12	---	---/---	---	---/---	---	---
LAG3	1	128/13	---	---/---	---	---/---	---	---
LAG4	1	128/14	---	---/---	---	---/---	---	---
LAG5	1	128/15	---	---/---	---	---/---	---	---
LAG6	1	128/16	---	---/---	---	---/---	---	---
LAG7	1	128/17	---	---/---	---	---/---	---	---
LAG8	1	128/18	---	---/---	---	---/---	---	---

Each field is described in the following table.

Table 51 Monitor &gt; Spanning Tree &gt; MST Port

LABEL	DESCRIPTION
MST Port	
MST ID	This is the unique identifier for this MST. Select a number from the drop-down menu to display results.
Port	This field displays the port number.
MSTI ID	A VLAN can be mapped to a specific Multiple Spanning Tree Instance (MSTI). MSTI allows multiple VLANs to use the same spanning tree.
Identifier (Priority / Port Id)	This field displays the identifier (in priority / port number).
Internal Path Cost(Operaton)	Path cost is the cost of transmitting a frame on to a LAN through that port. It is recommended to assign this value according to the speed of the bridge. The slower the media, the higher the cost.

Table 51 Monitor &gt; Spanning Tree &gt; MST Port (continued)

LABEL	DESCRIPTION
Regional Root Bridge	Root bridge refers to the base of the spanning tree.
Internal Root Cost	This field displays the internal root cost.
Designated Bridge	For each LAN segment, a designated bridge is selected. This bridge has the lowest cost to the root among the bridges connected to the LAN.
Port Role	This field displays the state of the port role.
Port State	This field displays the state of the port.

## 14.2.5 STP Statistics

(R)STP detects and breaks network loops and provides backup links between switches, bridges or routers. It allows a Switch to interact with other (R)STP-compliant switches in your network to ensure that only one path exists between any two stations on the network.

The Switch uses IEEE 802.1w RSTP (Rapid Spanning Tree Protocol) that allows faster convergence of the spanning tree than STP (while also being backwards compatible with STP-only aware bridges). In RSTP, topology change information is directly propagated throughout the network from the device that generates the topology change. In STP, a longer delay is required as the device that causes a topology change first notifies the root bridge and then the root bridge notifies the network. Both RSTP and STP flush unwanted learned addresses from the filtering database. In RSTP, the port states are Discarding, Learning, and Forwarding.

Note: In this user's guide, "STP" refers to both STP and RSTP.

Use this screen to view the Switch's spanning tree STP statistics. Click **Monitor > Spanning Tree > STP Statistics** to access this screen.

Figure 119 Monitor &gt; Spanning Tree &gt; STP Statistics

Port	MST Port			CIST CIST Port MST MST Port STP Statistics		
	Configuration BDPUs Received	TCN BDPUs Received	MSTP BDPUs Received	Configuration BDPUs Transmitted	TCN BDPUs Transmitted	MSTP BDPUs Transmitted
1	0	0	0	0	0	0
2	0	0	0	0	0	0
3	0	0	0	0	0	0
4	0	0	0	0	0	0
5	0	0	0	0	0	0
6	0	0	0	0	0	0
7	0	0	0	0	0	0
23	0	0	0	0	0	0
24	0	0	0	0	0	0
25	0	0	0	0	0	0
26	0	0	0	0	0	0
LAG1	0	0	0	0	0	0
LAG2	0	0	0	0	0	0
LAG3	0	0	0	0	0	0
LAG4	0	0	0	0	0	0
LAG5	0	0	0	0	0	0
LAG6	0	0	0	0	0	0
LAG7	0	0	0	0	0	0
LAG8	0	0	0	0	0	0

Each field is described in the following table.

Table 52 Monitor > Spanning Tree > STP Statistics

LABEL	DESCRIPTION
MST Port	
Port	This field displays the port number.
Configuration BDPUs Received	This field displays the configuration BDPUs received.
TCN BDPUs Received	This field displays the TCN BDPUs received.
MSTP BDPUs Received	This field displays the Multiple Spanning Tree Protocol (MSTP) BDPUs received.
Configuration BDPUs Transmitted	This field displays the configuration BDPUs transmitted.
TCN BDPUs Transmitted	This field displays the TCN BDPUs transmitted.
MSTP BDPUs Transmitted	This field displays the Multiple Spanning Tree Protocol (MSTP) BDPUs transmitted.

# CHAPTER 15

## Monitor: LLDP

### 15.1 Overview

This section provides information for LLDP in **Monitor**.

Link Layer Discovery Protocol (LLDP), defined as IEEE 802.1ab, enables LAN devices that support LLDP to exchange their configured settings. This helps eliminate configuration mismatch issues.

#### 15.1.1 What You Can Do in this Chapter

The LLDP screen ([Section 15.2 on page 110](#)) displays statistics, remote information, and overloading.

### 15.2 LLDP Settings

This link takes you to a screen where you can view LLDP on the Switch. LLDP allows a network device to advertise its identity and capabilities on the local network. It also allows the device to maintain and store information from adjacent devices which are directly connected to the network device.

#### 15.2.1 Statistics Settings

Use this screen to view the Switch's LLDP global and port statistics. Click **Monitor > LLDP > Statistics** to access this screen.

Figure 120 Monitor &gt; LLDP &gt; Statistics

Statistics		<a href="#">Statistics</a>	<a href="#">Remote Information</a>	<a href="#">Overloading</a>			
Insertions	1						
Deletions	0						
Drops	0						
Age Outs	0						
<input type="button" value="Clear"/> <input type="button" value="Refresh"/>							
LLDP Port Statistics							
Port	TX Frames		RX Frames		RX TLVs		RX Ageouts
	Total	Total	Discarded	Errors	Discarded	Unrecognized	Total
1	0	0	0	0	0	0	0
2	0	0	0	0	0	0	0
3	0	0	0	0	0	0	0
4	0	0	0	0	0	0	0
5	0	0	0	0	0	0	0
6	0	0	0	0	0	0	0
22	0	0	0	0	0	0	0
23	0	0	0	0	0	0	0
24	465	465	0	0	0	0	0
25	0	0	0	0	0	0	0
26	0	0	0	0	0	0	0

Each field is described in the following table.



Table 53 Monitor &gt; LLDP &gt; Statistics

LABEL	DESCRIPTION
Statistics	
Insertions	This field displays the number of insertions.
Deletions	This field displays the number of deletions.
Drops	This field displays the number of drops.
Age Outs	This field displays the number of age outs.
Clear	Click <b>Clear</b> to clear statistics.
Refresh	Click <b>Refresh</b> to reload the page.
LLDP Port Statistics	
Port	This field displays the port number.
TX Frames Total	This field displays the total number of TX LLDP frames.
RX Frames Total	This field displays the total number of RX LLDP frames.
RX Frames Discarded	This field displays the number of discarded RX LLDP frames.
RX Frames Errors	This field displays the number of RX LLDP frames errors.
RX TLVs Discarded	This field displays the number of discarded RX LLDP TLVs.
RX TLVs Unrecognized	This field displays the number of unrecognized RX LLDP TLVs.
RX Ageouts Total	This field displays the total number of RX LLDP ageouts.

## 15.2.2 Remote Information

Use this screen to view the Switch's LLDP remote device information. Click **Monitor > LLDP > Remote Information** to access this screen.

Figure 121 Monitor > LLDP > Remote Information

Remote Device				<a href="#">Statistics</a> <a href="#">Remote Information</a> <a href="#">Overloading</a>			
Local Port	Chassis ID Subtype	Chassis ID	Port ID Subtype	Port ID	System Name	Time to Live	Action
24	MAC address	E4:18:6B:F7:B A:79	Locally assigned	18	11A01_64	95	 

Each field is described in the following table.

Table 54 Monitor > LLDP > Remote Information

LABEL	DESCRIPTION
Remote Device	
Local Port	This field displays the local port.
Chassis ID Subtype	This field displays the chassis ID subtype.
Chassis ID	This field displays the chassis ID.
Port ID Subtype	This field displays the port ID subtype.
Port ID	This field displays the port ID.
System Name	This field displays the descriptive name of the Switch for identification purposes.
Time to Live	This field displays the live time of this entry.
Action	
Detail	Click <b>Detail</b> to show more information about this entry.
Delete	Click <b>Delete</b> to remove the entry.

### 15.2.3 Overloading

Use this screen to view the Switch's LLDP port overloading. Click **Monitor > LLDP > Overloading** to access this screen.

Figure 122 Monitor > LLDP > Overloading

Port Overloading										<a href="#">Statistics</a> <a href="#">Remote Information</a> <a href="#">Overloading</a>		
Port	Total(Bytes)	Left to Send(Bytes)	Status	Mandatory TLVs	MED Capabilities	MED Location	MED Network Policy	Bytes Detail				
								MED Extended Power via MDI	802.3 TLVs	Optional TLVs	MED Inventory	802.1 TLVs
1	81	1407	Not Overloading	19				11	43	8		
								(Transmitted)	(Transmitted)	(Transmitted)		
2	81	1407	Not Overloading	19				11	43	8		
								(Transmitted)	(Transmitted)	(Transmitted)		
3	81	1407	Not Overloading	19				11	43	8		
								(Transmitted)	(Transmitted)	(Transmitted)		
4	81	1407	Not Overloading	19				11	43	8		
								(Transmitted)	(Transmitted)	(Transmitted)		
5	81	1407	Not Overloading	19				11	43	8		
								(Transmitted)	(Transmitted)	(Transmitted)		
6	81	1407	Not Overloading	19				11	43	8		
								(Transmitted)	(Transmitted)	(Transmitted)		
22	82	1406	Not Overloading	20				11	43	8		
								(Transmitted)	(Transmitted)	(Transmitted)		
23	82	1406	Not Overloading	20				11	43	8		
								(Transmitted)	(Transmitted)	(Transmitted)		
24	82	1406	Not Overloading	20				11	43	8		
								(Transmitted)	(Transmitted)	(Transmitted)		
25	82	1406	Not Overloading	20				11	43	8		
								(Transmitted)	(Transmitted)	(Transmitted)		
26	82	1406	Not Overloading	20				11	43	8		
								(Transmitted)	(Transmitted)	(Transmitted)		



Each field is described in the following table.

Table 55 Monitor &gt; LLDP &gt; Overloading

LABEL	DESCRIPTION
Port Overloading	
Port	This label shows the port you are viewing.
Total (Bytes)	This field displays the total in bytes.
Left to Send (Bytes)	This field displays what is left to send in bytes.
Status	This field displays whether the Switch is overloading or not.
Bytes Detail	This field displays how many bytes used by TLVs
Mandatory TLVs	This field displays how many bytes used by mandatory TLVs.
MED Capabilities	This field displays how many bytes used by MED capabilities.
MED Location	This field displays how many bytes used by MED location.
MED Network Policy	This field displays how many bytes used by MED network policy.
MED Extended Power via MDI	This field displays how many bytes used by MED extended power through MDI.
802.3 TLVs	This field displays how many bytes used by 802.3 TLVs.
Optional TLVs	This field displays how many bytes used by optional TLVs.
MED Inventory	This field displays how many bytes used by MED inventory.
802.1 TLVs	This field displays how many bytes used by 802.1 TLVs.

# CHAPTER 16

## Monitor: Security

### 16.1 Overview

This section provides information for **Security** in **Monitor**.

This link takes you to a screen where you can view the settings or traffic statistics which contain detailed information about specific activities.

#### 16.1.1 What You Can Do in this Chapter

- The **Port Security** screen ([Section 16.2 on page 114](#)) displays global and port.
- The **802.1X** screen ([Section 16.3 on page 115](#)) displays port and authenticated hosts.

### 16.2 Port Security

Port security allows only packets with dynamically learned MAC addresses and/or configured static MAC addresses to pass through a port on the Switch. The Switch can learn up to 8K MAC addresses in total with no limit on individual ports; system total MAC address entry is 8K. Static MAC address still can be configured when port security is enabled; the function of port security is concerned with dynamic MAC address learn action. When total MAC address entry is 8k, static MAC can not be configured.

Use this screen to view Switch port security settings. Click **Monitor > Security > Port Security** to access this screen.

Figure 123 Monitor &gt; Security &gt; Port Security

Port Security				
Status		Disable		
<b>Port</b>				
Port	Status	Max MAC Entry Number	Current Addr Number	Action
1	Disable	Unlimited	0	---
2	Disable	Unlimited	0	---
3	Disable	Unlimited	0	---
4	Disable	Unlimited	0	---
5	Disable	Unlimited	0	---
6	Disable	Unlimited	0	---
7	Disable	Unlimited	0	---
8	Disable	Unlimited	0	---
9	Disable	Unlimited	0	---
10	Disable	Unlimited	0	---
11	Disable	Unlimited	0	---
12	Disable	Unlimited	0	---
13	Disable	Unlimited	0	---
14	Disable	Unlimited	0	---
15	Disable	Unlimited	0	---
16	Disable	Unlimited	0	---
17	Disable	Unlimited	0	---
18	Disable	Unlimited	0	---
19	Disable	Unlimited	0	---
20	Disable	Unlimited	0	---
21	Disable	Unlimited	0	---
22	Disable	Unlimited	0	---
23	Disable	Unlimited	0	---
24	Disable	Unlimited	0	---
25	Disable	Unlimited	0	---
26	Disable	Unlimited	0	---
LAG1	Disable	Unlimited	0	---
LAG2	Disable	Unlimited	0	---
LAG3	Disable	Unlimited	0	---
LAG4	Disable	Unlimited	0	---
LAG5	Disable	Unlimited	0	---
LAG6	Disable	Unlimited	0	---
LAG7	Disable	Unlimited	0	---
LAG8	Disable	Unlimited	0	---

Each field is described in the following table.

Table 56 Monitor &gt; Security &gt; Port Security

LABEL	DESCRIPTION
Port Security	
Status	This field displays the status of global control information.
Port	
Port	This field displays a port number.
Status	This field displays the status of port based control information.
Max MAC Entry Number	Displays the designated maximum number of allowed MAC entries. The maximum MAC entry number can be learned for individual ports.
Current Addr Number	This field displays the number of the current addr.
Action	This field displays the actions the Switch takes on the associated classified traffic flow.

## 16.3 802.1X Security Settings

Use this screen to view Switch 802.1x security settings.

### 16.3.1 Port Settings

Use this screen to view the Switch's 802.1x port status. Click **Monitor > Security > 802.1X > Port** to access this screen.

**Figure 124** Monitor > Security > 802.1X > Port

Port Status		<a href="#">Port</a>	<a href="#">Authenticated Hosts</a>
Port	Status		
1	---		
2	---		
3	---		
4	---		
5	---		
6	---		
7	---		
8	---		
9	---		
10	---		
11	---		
12	---		
13	---		
14	---		
15	---		
16	---		
17	---		
18	---		
19	---		
20	---		
21	---		
22	---		
23	---		
24	---		
25	---		
26	---		

Each field is described in the following table.

**Table 57** Monitor > Security > 802.1X > Port

LABEL	DESCRIPTION
Port Status	
Port	This label shows the port you are viewing.
Status	This field displays status of the port.

### 16.3.2 Authenticated Hosts

Use this screen to view the Switch's 802.1x security authenticated host status. Click **Monitor > Security > 802.1X > Authenticated Hosts** to access this screen.

**Figure 125** Monitor > Security > 802.1X > Authenticated Hosts

Authenticated Hosts					<a href="#">Port</a>	<a href="#">Authenticated Hosts</a>
User Name	Port	Session Time	Authentication Method	MAC Address		

Each field is described in the following table.

**Table 58** Monitor > Security > 802.1X > Authenticated Hosts

LABEL	DESCRIPTION
Authenticated Hosts	
User Name	This field displays the name of a user.
Port	This label shows the port you are viewing.
Session Time	This label shows the session time.
Authentication Method	This label shows the authentication method.
MAC Address	This field displays the source MAC address in the binding.

# CHAPTER 17

## Monitor: Management

### 17.1 Overview

This section provides information for **Management** in **Monitor**.

This chapter describes how to view management settings on the Switch.

#### 17.1.1 What You Can Do in this Chapter

- The **Syslog** screen ([Section 17.2 on page 117](#)) displays logging filter select and shows system log.
- The **Error Disable** screen ([Section 17.3 on page 118](#)) displays global and port.

### 17.2 Syslog

Use this screen to view Switch syslog management. Click **Monitor > Management > Syslog** to access this screen.

**Figure 126** Monitor > Management > Syslog

No.	Timestamp	Category	Severity	Message
-----	-----------	----------	----------	---------

Each field is described in the following table.

**Table 59** Monitor > Management > Syslog

LABEL	DESCRIPTION
Logging Filter Select	
Target	Select <b>Buffered</b> or <b>Flash</b> . Buffered: Login saved to temporary memory. Flash: Login saved to permanent memory.

Table 59 Monitor &gt; Management &gt; Syslog (continued)

LABEL	DESCRIPTION
Severity	This field displays two options: Available and Acting. Severity type: crit, emerg, alert, error, warning, notice, info, and debug.
Available	Click < to move a severity type from the acting box to the available box. Click > to move a severity type to the acting box from the available box.
Acting	Click < to move a severity type from the acting box to the available box. Click > to move a severity type to the acting box from the available box.
>	Click > to move a severity type to the acting box from the available box.
<	Click < to move a severity type from the acting box to the available box.
View	Click <b>View</b> to display results.
Clear	Click <b>Clear</b> to clear results.
Show System Log	The syslog protocol allows devices to send event notification messages across an IP network to syslog servers that collect the event messages. A syslog-enabled device can generate a syslog message and send it to a syslog server
No.	This field displays the number you are viewing.
Timestamp	This field displays the timestamp.
Category	This field displays the category.
Severity	This field displays the severity.
Message	The syslog protocol allows devices to send event notification messages across an IP network to syslog servers that collect the event messages. A syslog-enabled device can generate a syslog message and send it to a syslog server.

## 17.3 Error Disable

This link takes you to a screen where you can view CPU protection and error disable recovery.

Use this screen to view Switch global and port error disable management. Click **Monitor > Management > Error Disable** to access this screen.

Figure 127 Monitor &gt; Management &gt; Error Disable

Error Disable			
Recovery Interval	300 sec		
<b>Reason Status</b>			
Error Disabled Reason	Timer Status		
Broadcast Flood	Disable		
Unknown Multicast Flood	Disable		
Unicast Flood	Disable		
Port Security	Disable		
<b>Port Status</b>			
Port	Error Disabled Reason	Time Left (sec)	Action
1	---	---	Recovery
2	---	---	Recovery
3	---	---	Recovery
4	---	---	Recovery
5	---	---	Recovery
6	---	---	Recovery
7	---	---	Recovery
8	---	---	Recovery
20	---	---	Recovery
LAG1	---	---	Recovery
LAG2	---	---	Recovery
LAG3	---	---	Recovery
LAG4	---	---	Recovery
LAG5	---	---	Recovery
LAG6	---	---	Recovery
LAG7	---	---	Recovery
LAG8	---	---	Recovery

Each field is described in the following table.

Table 60 Monitor &gt; Management &gt; Error Disable

LABEL	DESCRIPTION
Error Disable	
Recovery Interval	View the number of seconds (from 30 to 2592000) for the time interval of the recovery.
Reason Status	
Error Disabled Reason	This field displays the supported features that allow the Switch to shut down a port or discard packets on a port according to the feature requirements and what action you configure.
Timer Status	Select this option to allow the Switch to wait for the specified time interval to activate a port or allow specific packets on a port, after the error was gone. De-select this option to turn off this rule.
Port Status	
Port	This field displays the port number.
Error Disabled Reason	This field displays the supported features that allow the Switch to shut down a port or discard packets on a port according to the feature requirements and what action you configure.
Time Left (sec)	This field displays the time left in seconds.
Action	This field displays the action.

# CHAPTER 18

## Configuration: System

### 18.1 Overview

This section provides information for **System** in **Configuration**.

#### 18.1.1 What You Can Do in this Chapter

- The **IP** screen ([Section 18.2 on page 120](#)) displays IPv4 and IPv6 settings.
- The **Time** screen ([Section 18.3 on page 122](#)) displays the system time and SNTP settings.
- The **Information** screen ([Section 18.4 on page 123](#)) displays the system information.

### 18.2 IP Settings

The Switch needs an IP address for it to be managed over the network. The factory default IP address is 192.168.1.1. The subnet mask specifies the network number portion of an IP address. The factory default subnet mask is 255.255.255.0.

#### 18.2.1 IPv4 Settings

Use this screen to view the IPv4 interface status and Switch's management IPv4 addresses. Click **Configuration > System > IP > IPv4** to open this screen.

**Figure 128** Configuration > System > IP > IPv4

IPv4 Address		<a href="#">IPv4</a>	<a href="#">IPv6</a>
Mode	<input checked="" type="radio"/> Static <input type="radio"/> DHCP		
IP Address	10.214.80.211		
Subnet Mask	255.255.255.0		
Gateway	0.0.0.0		
DNS 1	0.0.0.0		
DNS 2	0.0.0.0		
Management VLAN	1	(1 - 4094)	

[Apply](#) [Cancel](#)



The following table describes the labels in this screen.

Table 61 Configuration > System > IP > IPv4

LABEL	DESCRIPTION
IPv4 Address	
Mode	Select <b>Static</b> to define the IPv4 network properties or <b>DHCP</b> to allow the device to define the properties.
IP Address	Enter the IP address of the Switch in the IP domain.
Subnet Mask	Enter the subnet mask of the Switch in the IP domain.
Gateway	Enter the IP address of the default outgoing gateway in dotted decimal notation, for example 192.168.1.254.
DNS 1	Enter the IP address for the primary domain name server. DNS (Domain Name System) is for mapping a domain name to its corresponding IP address and vice versa.
DNS 2	Enter the IP address for the secondary domain name server. DNS (Domain Name System) is for mapping a domain name to its corresponding IP address and vice versa.
Management VLAN	Enter the port number of the management VLAN.
Apply	Click <b>Apply</b> to save the changes.
Cancel	Click <b>Cancel</b> to discard the changes.

## 18.2.2 IPv6 Settings

Use this screen to view the IPv6 interface status and Switch's management IPv6 addresses.

Click **Configuration > System > IP > IPv6** to open this screen.

Figure 129 Configuration > System > IP > IPv6

The following table describes the labels in this screen.

Table 62 Configuration > System > IP > IPv6

LABEL	DESCRIPTION
IPv6 Address	
DHCPv6 Client	Select <b>Enable</b> to allow the device to act as a DHCPv6 client or <b>Disable</b> to disallow it. This field displays the Switch's DHCP settings when it is acting as a DHCPv6 client.
Auto Configuration	Select <b>Enable</b> to allow the device to auto-configure the IPv6 properties or <b>Disable</b> to manually enter the properties.
IPv6 Address	Enter the IPv6 address of the Switch in the IP domain.
Gateway	Enter the IPv6 address of the default outgoing gateway.

Table 62 Configuration &gt; System &gt; IP &gt; IPv6 (continued)

LABEL	DESCRIPTION
Apply	Click <b>Apply</b> to save the changes.
Cancel	Click <b>Cancel</b> to discard the changes.

## 18.3 Time

The Time option is used to setup the system time and SNTP (Simple Network Time Protocol) server settings.

### 18.3.1 System Time Settings

In the navigation panel, click **Configuration > System > Time > System Time** to display the screen as shown.

Figure 130 Configuration &gt; System &gt; Time &gt; System Time

The following table describes the labels in this screen.

Table 63 Configuration &gt; System &gt; Time &gt; System Time

LABEL	DESCRIPTION
System Time	
Enable SNTP	Select <b>Enable</b> to enable using a simple network time protocol (SNTP) server to manage the system time or <b>Disable</b> to manually manage system time.
Manual Time	Select the system date and time values from the dropdown lists.
Time Zone	Select the time zone from the dropdown list.
Daylight Saving Time	Select <b>Enable</b> to use Daylight Saving Time to offset the system time or <b>Disable</b> to not adjust system time.
Daylight Saving Time Offset	Enter the daylight saving time offset value in minutes.
Start Date	Select the start date of the daylight saving time period from the dropdown lists.
End Date	Select the end date of the daylight saving time period from the dropdown lists.
Apply	Click <b>Apply</b> to save the changes.
Cancel	Click <b>Cancel</b> to discard the changes.

## 18.3.2 SNTP Server Settings

In the navigation panel, click **Configuration > System > Time > SNTP Server** to display the screen as shown.

**Figure 131** Configuration > System > Time > SNTP Server

SNTP Server		<a href="#">System Time</a> <a href="#">SNTP Server</a>
Server	<input type="text"/>	( X.X.X.X or Hostname )
Server Port	123	( 1 - 65535 )
<input type="button" value="Apply"/> <input type="button" value="Cancel"/>		

The following table describes the labels in this screen.

Table 64 Configuration > System > Time > SNTP Server

LABEL	DESCRIPTION
SNTP Server	
Server	Enter the address of the simple network time protocol (SNTP) server as an IP address (192.168.0.1) or as a URL (www.zyxel.com).
Server Port	Enter the port number of the SNTP server. The numeric value can be between 1 and 65535.
Apply	Click <b>Apply</b> to save the changes.
Cancel	Click <b>Cancel</b> to discard the changes.

## 18.4 Information

The information option is used to set the following system information properties: system name, system location, and system contact information.

### 18.4.1 System Information Settings

In the navigation panel, click **Configuration > System > Information > System Information** to display the screen as shown. You can set the system name, system location, and system contact.

**Figure 132** Configuration > System > Information > System Information

System Information	
System Name	GS1900
System Location	Location
System Contact	Contact
<input type="button" value="Apply"/> <input type="button" value="Cancel"/>	

The following table describes the labels in this screen.

Table 65 Configuration > System > Information > System Information

LABEL	DESCRIPTION
System Information	
System Name	Enter the descriptive name of the Switch for identification purposes.
System Location	Enter the geographic location of the Switch for identification purposes.
System Contact	Enter the person in charge of the Switch for identification purposes.
Apply	Click <b>Apply</b> to save the changes.
Cancel	Click <b>Cancel</b> to discard the changes.

# CHAPTER 19

## Configuration: Port

### 19.1 Overview

This section provides information for **Port** in **Configuration**.

#### 19.1.1 What You Can Do in this Chapter

- The **Port** screen ([Section 19.2 on page 125](#)) displays general port settings.
- The **EEE** screen ([Section 19.3 on page 127](#)) displays the port EEE settings.
- The **PoE** screen ([Section 19.4 on page 129](#)) displays the port PoE settings.
- The **Bandwidth Management** screen ([Section 19.5 on page 134](#)) displays the port ingress and egress settings.
- The **Storm Control** screen ([Section 19.6 on page 135](#)) displays the port storm control settings.

### 19.2 Port Settings

Use this screen to view and edit general port settings.

#### 19.2.1 Port

Use this screen to view Switch port settings and select ports for configuration. Click **Configuration > Port > Port** to open this screen.

Figure 133 Configuration &gt; Port &gt; Port

Port							
<input type="checkbox"/>	Port	Port Name	State	Link Status	Speed	Duplex	FlowCtrl State
<input type="checkbox"/>	1		Enable	Down	Auto	Auto	Disable
<input type="checkbox"/>	2		Enable	Down	Auto	Auto	Disable
<input type="checkbox"/>	3		Enable	Down	Auto	Auto	Disable
<input type="checkbox"/>	4		Enable	Down	Auto	Auto	Disable
<input type="checkbox"/>	5		Enable	Down	Auto	Auto	Disable
<input type="checkbox"/>	6		Enable	Down	Auto	Auto	Disable
<input type="checkbox"/>	7		Enable	Down	Auto	Auto	Disable
<input type="checkbox"/>	8		Enable	Down	Auto	Auto	Disable
<input type="checkbox"/>	9		Enable	Down	Auto	Auto	Disable
<input type="checkbox"/>	10		Enable	Down	Auto	Auto	Disable
<input type="checkbox"/>	11		Enable	Down	Auto	Auto	Disable
<input type="checkbox"/>	12		Enable	Down	Auto	Auto	Disable
<input type="checkbox"/>	13		Enable	Down	Auto	Auto	Disable
<input type="checkbox"/>	14		Enable	Down	Auto	Auto	Disable
<input type="checkbox"/>	15		Enable	Down	Auto	Auto	Disable
<input type="checkbox"/>	16		Enable	Down	Auto	Auto	Disable
<input type="checkbox"/>	17		Enable	Down	Auto	Auto	Disable
<input type="checkbox"/>	18		Enable	Down	Auto	Auto	Disable
<input type="checkbox"/>	19		Enable	Down	Auto	Auto	Disable
<input type="checkbox"/>	20		Enable	Down	Auto	Auto	Disable
<input type="checkbox"/>	21		Enable	Down	Auto	Auto	Disable
<input type="checkbox"/>	22		Enable	Down	Auto	Auto	Disable
<input type="checkbox"/>	23		Enable	Down	Auto	Auto	Disable
<input type="checkbox"/>	24		Enable	Up	Auto	Auto	Disable
<input type="checkbox"/>	25		Enable	Down	Auto	Auto	Disable
<input type="checkbox"/>	26		Enable	Down	Auto	Auto	Disable

The following table describes the labels in this screen.

Table 66 Configuration &gt; Port &gt; Port

LABEL	DESCRIPTION
Port	
Port	Displays the port index number.
Port Name	Displays a descriptive name that identifies this port. The length of the name can be up to 32 alpha-numerical characters.  Note: Due to space limitations, the port name may be truncated in some Web Configurator screens.
State	Displays the port status as enabled or disabled.
Link Status	Displays the link status as up or down.
Speed	Displays the speed of the Ethernet connection on this port. The choices are <b>Auto</b> , <b>10M</b> , <b>100M</b> , and <b>1000M</b> .
Duplex	Displays the duplex mode of the Ethernet connection on this port. The choices are <b>auto</b> , <b>full</b> , or <b>half</b> .
FlowCtrl State	Displays the flow control state as enabled or disabled. A concentration of traffic on a port decreases port bandwidth and overflows buffer memory causing packet discards and frame losses. Flow Control is used to regulate transmission of signals to match the bandwidth of the receiving port.
Edit	Select this check box to configure the properties of a port. Click the <b>Edit</b> button change the properties of the port.
Cancel	Click <b>Cancel</b> to discard the changes.

## 19.2.2 Port Edit

Use this screen to configure Switch port settings. Click **Configuration > Port > Port > Edit** to open this screen.

Figure 134 Configuration &gt; Port &gt; Port &gt; Edit

Port	
Port List	16
Port Name	<input type="text"/>
State	<input checked="" type="radio"/> Enable <input type="radio"/> Disable
Speed	<input checked="" type="radio"/> Auto <input type="radio"/> 10M <input type="radio"/> 100M <input type="radio"/> 1000M
Duplex	<input checked="" type="radio"/> Auto <input type="radio"/> Full <input type="radio"/> Half
Flow Control	<input type="radio"/> Enable <input checked="" type="radio"/> Disable
<input type="button" value="Apply"/> <input type="button" value="Cancel"/>	

The following table describes the labels in this screen.

Table 67 Configuration &gt; Port &gt; Port &gt; Edit

LABEL	DESCRIPTION
Port	
Port List	Displays the list of port index numbers that are being configured.
Port Name	Enter a descriptive name that identifies this port. The length of the name can be up to 32 alpha-numerical characters.  Note: Due to space limitations, the port name may be truncated in some Web Configurator screens.
State	Select <b>Enable</b> to enable the ports or <b>Disable</b> to disable them.
Speed	Select the speed of the Ethernet connection on this port. The choices are <b>Auto</b> , <b>10M</b> , <b>100M</b> , and <b>1000M</b> .
Duplex	Select the duplex mode of the Ethernet connection on this port. The choices are <b>Auto</b> , <b>Full</b> , or <b>Half</b> .
FlowCtrl State	Select <b>Enable</b> to allow the device to manage data flow or <b>Disable</b> to have no data flow management. A concentration of traffic on a port decreases port bandwidth and overflows buffer memory causing packet discards and frame losses. Flow Control is used to regulate transmission of signals to match the bandwidth of the receiving port.
Apply	Click <b>Apply</b> to save the changes.
Cancel	Click <b>Cancel</b> to discard the changes.

## 19.3 EEE Settings

Use this screen to view and edit the port EEE settings.

### 19.3.1 EEE

Use this screen to view Switch port Energy-Efficient Ethernet (EEE) settings and select ports for configuration. Click **Configuration > Port > EEE > EEE** to open this screen.

**Figure 135** Configuration > Port > EEE > EEE

Port	State
1	Disable
2	Disable
3	Disable
4	Disable
5	Disable
6	Disable
7	Disable
21	Disable
22	Disable
23	Disable
24	Disable
25	Disable
26	Disable

The following table describes the labels in this screen.

**Table 68** Configuration > Port > EEE > EEE

LABEL	DESCRIPTION
EEE	
Port	Displays the port index number.
State	Displays the port status as enabled or disabled.
Edit	Select this check box to configure the properties of a port. Click the <b>Edit</b> button change the properties of the port.
Cancel	Click <b>Cancel</b> to discard the changes.

### 19.3.2 EEE Edit

Use this screen to configure Switch port EEE settings. Click **Configuration > Port > EEE > EEE > Edit** to open this screen.

**Figure 136** Configuration > Port > EEE > EEE > Edit

The following table describes the labels in this screen.

**Table 69** Configuration > Port > EEE > EEE > Edit

LABEL	DESCRIPTION
EEE	
Port List	Displays the list of port index numbers that are being configured.
State	Select <b>Enable</b> to designate the ports as EEE or <b>Disable</b> to not designate them as EEE.



Table 69 Configuration &gt; Port &gt; EEE &gt; EEE &gt; Edit (continued)

LABEL	DESCRIPTION
Apply	Click <b>Apply</b> to save the changes.
Cancel	Click <b>Cancel</b> to discard the changes.

## 19.4 PoE Settings

The Switch supports both the IEEE 802.3af Power over Ethernet (PoE) and IEEE 802.3at High Power over Ethernet (PoE) standards. The Switch is Power Sourcing Equipment (PSE) because it provides a source of power through its Ethernet ports, and each device that receives power through an Ethernet port is a Powered Device (PD).

### 19.4.1 Global Settings

In the navigation panel, click **Configuration > Port > PoE > Global** to display the screen as shown. Use this screen to configure Power over Ethernet (PoE) global settings.

Figure 137 Configuration &gt; Port &gt; PoE &gt; Global

The following table describes the labels in this screen.

Table 70 Configuration &gt; Port &gt; PoE &gt; Global

LABEL	DESCRIPTION
PoE Mode	Select the power management mode you want the Switch to use. <ul style="list-style-type: none"> <li><b>Classification</b> – Select this if you want the Switch to reserve the maximum power for each PD according to the PD's power class and priority level. If the total power supply runs out, PDs with lower priority do not get power to function. In this mode, the maximum power is reserved based on what you configure in <b>Max Power</b> or the standard power limit for each class.</li> <li><b>Consumption</b> – Select this if you want the Switch to supply the actual power that the PD needs. The Switch also allocates power based on a port's <b>Max Power</b> and the PD's power class and priority level. The Switch puts a limit on the maximum amount of power the PD can request and use. In this mode, the default maximum power that can be delivered to the PD is 33 W (IEEE 802.3at Class 4) or 22 W (IEEE 802.3af Classes 0 to 3).</li> </ul>
Pre-Allocate	This field is only available on GS1900-8HP (Revision B1) and GS1900-10HP only. Select <b>Enable</b> to have the Switch pre-allocate power to each port based on the classification of the PD device. Otherwise, select <b>Disable</b> .
Apply	Click <b>Apply</b> to save the changes.
Cancel	Click <b>Cancel</b> to discard the changes.

### 19.4.2 Port Settings

Use this screen to view Switch port PoE settings and select ports for configuration. Click **Configuration > Port > PoE > Port** to open this screen.

Figure 138 Configuration &gt; Port &gt; PoE &gt; Port

PoE Port										<a href="#">Global</a> <a href="#">Port</a>
<input type="checkbox"/>	Port	State	Class	PD Priority	Power-Up	Wide Range Detection	Consuming Power (mW)	Max Power (mW)	Time Range Name	Status
<input type="checkbox"/>	1	Enable	class0	Low	802.3at	Disable	0	0	-	-
<input type="checkbox"/>	2	Enable	class0	Low	802.3at	Disable	0	0	-	-
<input type="checkbox"/>	3	Enable	class0	Low	802.3at	Disable	0	0	-	-
<input type="checkbox"/>	4	Enable	class0	Low	802.3at	Disable	0	0	-	-
<input type="checkbox"/>	5	Enable	class0	High	802.3at	Disable	0	0	-	-
<input type="checkbox"/>	6	Enable	class0	High	802.3at	Disable	0	0	-	-
<input type="checkbox"/>	7	Enable	class0	High	802.3at	Disable	0	0	-	-
<input type="checkbox"/>	8	Enable	class0	Low	802.3at	Disable	0	0	-	-
<input type="checkbox"/>	9	Enable	class0	Low	802.3a	Disable	0	0	-	-
<input type="checkbox"/>	20	Enable	class0	Low	802.3a	Disable	0	0	-	-
<input type="checkbox"/>	21	Enable	class0	Low	802.3a	Disable	0	0	-	-
<input type="checkbox"/>	22	Enable	class0	Low	802.3a	Disable	0	0	-	-
<input type="checkbox"/>	23	Enable	class0	Low	802.3a	Disable	0	0	-	-
<input type="checkbox"/>	24	Enable	class0	Low	802.3a	Disable	0	0	-	-

[Edit](#) [Cancel](#)

The following table describes the labels in this screen.

Table 71 Configuration &gt; Port &gt; PoE &gt; Port

LABEL	DESCRIPTION
Edit	Select one or more ports in the first column of the table and click this to configure PoE settings for the ports.
Port	Displays the port index number.
State	Displays which ports can receive power from the Switch. You can set this in the <b>Configuration &gt; Port &gt; PoE Edit</b> screen. <ul style="list-style-type: none"> <li><b>Disable</b> – The powered device (PD) connected to this port cannot get power.</li> <li><b>Enable</b> – The PD connected to this port can receive power.</li> </ul>
Class	This shows the power classification of the PD. Each PD has a specified maximum power that fall under one of the classes.  The Class is a number from 0 to 4, where each value represents the range of power that the Switch provides to the PD. The power ranges for each class are as follows. <ul style="list-style-type: none"> <li><b>Class 0</b> – Default, 0.44 to 12.94</li> <li><b>Class 1</b> – Optional, 0.44 to 3.84</li> <li><b>Class 2</b> – Optional, 3.84 to 6.49</li> <li><b>Class 3</b> – Optional, 6.49 to 12.95</li> <li><b>Class 4</b> – Reserved (PSEs classify as Class 0) in a switch that supports IEEE 802.3af only. Optional, 12.95 to 25.50 in a switch that supports IEEE 802.3at.</li> </ul>
PD Priority	When the total power requested by the PDs exceeds the total PoE power budget on the Switch, you can set the PD priority to allow the Switch to provide power to ports with higher priority first. <ul style="list-style-type: none"> <li><b>Critical</b> has the highest priority.</li> <li><b>High</b> has the Switch assign power to the port after all critical priority ports are served.</li> <li><b>Medium</b> has the Switch assign power to the port after all critical and high priority ports are served.</li> <li><b>Low</b> has the Switch assign power to the port after all critical, high and medium priority ports are served.</li> </ul>

Table 71 Configuration &gt; Port &gt; PoE &gt; Port (continued)

LABEL	DESCRIPTION
Power-Up	<p>This shows how the Switch provides power to the connected PD at power-up.</p> <p><b>802.3af</b> – the Switch follows the IEEE 802.3af Power over Ethernet standard to supply power to the connected PDs during power-up.</p> <p><b>Legacy</b> – the Switch can provide power to the connected PDs that require high inrush currents at power-up.</p> <p><b>Pre-802.3at</b> – the Switch initially offers power on the port according to the IEEE 802.3af standard, and then switches to support the IEEE 802.3at standard within 75 milliseconds after a PD is connected to the port. Select this option if the Switch is performing 2-event Layer-1 classification (PoE+ hardware classification) or the connected PD is NOT performing Layer 2 power classification using Link Layer Discovery Protocol (LLDP).</p> <p><b>802.3at</b> – the Switch supports the IEEE 802.3at High Power over Ethernet standard and can supply power of up to 30W per Ethernet port. IEEE 802.3at is also known as PoE+ or PoE Plus. An IEEE 802.3at compatible device is referred to as Type 2. Power Class 4 (High Power) can only be used by Type 2 devices. If the connected PD requires a Class 4 current when it is turned on, it will be powered up in this mode.</p>
Wide Range Detection	<p>This field is available on GS1900-8HP (Revision B1) and GS1900-10HP only.</p> <p>This shows whether the Switch enables a wider detection range for the PD or not.</p> <p>The Switch detects whether a connected device is a powered device or not before supplying power to the port. For the PD detection, the Switch applies a fixed voltage to the device and then receives returned current. If the returned current is within the IEEE 802.3AF/AT standard range, the device will be considered as a valid PD by the Switch.</p> <p>However, in real cases, environmental interferences might easily cause the returned current out of the standard range. This field displays <b>Enable</b> if the Switch applies a wider range for PD detection. Otherwise, it displays <b>Disable</b>.</p>
Consuming Power (mW)	This field displays the current amount of power consumed by the PD from the Switch on this port.
Max Power (mW)	This field displays the maximum amount of power the PD could use from the Switch on this port.
Time Range	
Name	This field displays the name of the time range (schedule) rule which is applied to the port. PoE is enabled at the specified time or date.
Status	<p>This field displays whether the port can receive power from the Switch (<b>In</b>) or not (<b>Out</b>) currently.</p> <p>It shows – if there is no schedule applied to the port.</p>

### 19.4.3 PoE Edit

Use this screen to configure Switch port PoE settings. Select a port and click **Edit** in the **Configuration > Port > PoE > Port** screen to open this screen.

Figure 139 Configuration &gt; Port &gt; PoE &gt; Port &gt; Edit

The following table describes the labels in this screen.

Table 72 Configuration &gt; Port &gt; PoE &gt; Port &gt; Edit

LABEL	DESCRIPTION
PoE Port	
Port List	Displays the list of port index numbers that are being configured.
PD State	Select <b>Enable</b> to provide power to a PD connected to the port or <b>Disable</b> so the port cannot receive power from the Switch.
PD Priority	<p>This field is not available for the SFP or SFP+ ports.</p> <p>When the total power requested by the PDs exceeds the total PoE power budget on the Switch, you can set the PD priority to allow the Switch to provide power to ports with higher priority.</p> <p>Select <b>Critical</b> to give the PD connected to this port the highest priority.</p> <p>Select <b>High</b> to set the Switch to assign the remaining power to the port after all critical priority ports are served.</p> <p>Select <b>Medium</b> to set the Switch to assign the remaining power to the port after all critical and high priority ports are served.</p> <p>Select <b>Low</b> to set the Switch to assign the remaining power to the port after all critical, high and medium priority ports are served.</p>
Power-Up	<p>Set how the Switch provides power to a connected PD at power-up.</p> <p><b>802.3af</b> – the Switch follows the IEEE 802.3af Power over Ethernet standard to supply power to the connected PDs during power-up.</p> <p><b>Legacy</b> – the Switch can provide power to the connected PDs that require high inrush currents at power-up.</p> <p><b>Pre-802.3at</b> – the Switch initially offers power on the port according to the IEEE 802.3af standard, and then switches to support the IEEE 802.3at standard within 75 milliseconds after a PD is connected to the port. Select this option if the Switch is performing 2-event Layer-1 classification (PoE+ hardware classification) or the connected PD is NOT performing Layer 2 power classification using Link Layer Discovery Protocol (LLDP).</p> <p><b>802.3at</b> – the Switch supports the IEEE 802.3at High Power over Ethernet standard and can supply power of up to 30W per Ethernet port. IEEE 802.3at is also known as PoE+ or PoE Plus. An IEEE 802.3at compatible device is referred to as Type 2. Power Class 4 (High Power) can only be used by Type 2 devices. If the connected PD requires a Class 4 current when it is turned on, it will be powered up in this mode.</p>

Table 72 Configuration &gt; Port &gt; PoE &gt; Port &gt; Edit (continued)

LABEL	DESCRIPTION
Wide Range Detection	<p>This field is available on the GS1900-8HP (Revision B1) and GS1900-10HP only.</p> <p>Select whether to enable a wider detection range for the PD or not.</p> <p>The Switch detects whether a connected device is a powered device or not before supplying power to the port. For the PD detection, the Switch applies a fixed voltage to the device and then receives returned current. If the returned current is within the IEEE 802.3AF/AT standard range, the device will be considered as a valid PD by the Switch.</p> <p>However, in real cases, environmental interferences might easily cause the returned current out of the standard range. This field displays <b>Enable</b> if the Switch applies a wider range for PD detection. Otherwise, it displays <b>Disable</b>.</p>
Max Power Type	<p>Select <b>Classification-based</b> to have the Switch automatically decide the maximum amount of power it can provide on the port according to the connected PD's power classification.</p> <p>Select <b>User-defined</b> to manually specify the maximum amount of power the PD could use from the Switch on this port.</p>
Max Power Threshold	<p>Specify the maximum amount of power the Switch can provide on the port if you set <b>Max Power Type</b> to <b>User-defined</b>.</p> <p>Enter a value between 1000 and 33000 in increments of 200.</p>
Time Range	<p>Select a pre-defined schedule (created using the <b>Time Range</b> screen) to control when the Switch enables PoE to provide power on the port.</p> <p>If you leave this field blank, there is no schedule applied to the port.</p>
Apply	Click <b>Apply</b> to save the changes.
Cancel	Click <b>Cancel</b> to discard the changes.

## 19.5 Bandwidth Management

Bandwidth management means defining a maximum allowable bandwidth for incoming and/or outgoing traffic flows on a port.

### 19.5.1 Bandwidth Control

Use this screen to view Egress Bandwidth Management settings and select ports for configuration. Click **Configuration > Port > Bandwidth Management > Egress Global Burst** to open this screen.

**Figure 140** Configuration > Port > Bandwidth Management > Egress Global Burst

Egress Global Burst			
Egress Global Burst	40000	(4578-50000, unit: Byte)	
<input type="button" value="Apply"/> <input type="button" value="Cancel"/>			
Port Rate			
<input type="checkbox"/>	Port	Ingress RateLimit (Kbps)	Egress RateLimit (Kbps)
<input type="checkbox"/>	1	Disable	Disable
<input type="checkbox"/>	2	Disable	Disable
<input type="checkbox"/>	3	Disable	Disable
<input type="checkbox"/>	4	Disable	Disable
<input type="checkbox"/>	5	Disable	Disable
<input type="checkbox"/>	6	Disable	Disable
<input type="checkbox"/>	7	Disable	Disable
<input type="checkbox"/>	22	Disable	Disable
<input type="checkbox"/>	23	Disable	Disable
<input type="checkbox"/>	24	Disable	Disable
<input type="checkbox"/>	25	Disable	Disable
<input type="checkbox"/>	26	Disable	Disable
<input type="button" value="Edit"/> <input type="button" value="Cancel"/>			

The following table describes the labels in this screen.

**Table 73** Configuration > Port > Bandwidth Management > Egress Global Burst

LABEL	DESCRIPTION
Egress Global Burst	
Egress Global Burst	Specify the current egress burst size in bytes for all ports.
Port Rate	
Port	Displays the port index number.
Ingress Rate Limit (Kbps)	Displays the maximum bandwidth allowed in kilobits per second (Kbps) for the incoming traffic flow on a port.
Egress Rate Limit (Kbps)	Displays the maximum bandwidth allowed in kilobits per second (Kbps) for the outgoing traffic flow on a port.

Table 73 Configuration &gt; Port &gt; Bandwidth Management &gt; Egress Global Burst (continued)

LABEL	DESCRIPTION
Edit	Select this check box to configure the properties of a port. Click the <b>Edit</b> button change the properties of the port.
Cancel	Click <b>Cancel</b> to discard the changes.

## 19.5.2 Port Rate Edit

Use this screen to configure port rate Bandwidth Management settings. Click **Configuration > Port > Bandwidth Management > Egress Global Burst > Edit** to open this screen.

Figure 141 Configuration &gt; Port &gt; Bandwidth Management &gt; Egress Global Burst &gt; Edit

The following table describes the labels in this screen.

Table 74 Configuration &gt; Port &gt; Bandwidth Management &gt; Egress Global Burst &gt; Edit

LABEL	DESCRIPTION
Port Rate	
Port List	Displays the list of port index numbers that are being configured.
Ingress State	Select <b>Enable</b> to activate ingress peak rate limits on the ports.
Ingress Bandwidth (Kbps)	Enter the maximum bandwidth allowed in kilobits per second (Kbps) for the outgoing traffic flow on a port.
Egress State	Select <b>Enable</b> to activate egress peak rate limits on the ports.
Egress Bandwidth (Kbps)	Enter the maximum bandwidth allowed in kilobits per second (Kbps) for the outgoing traffic flow on a port.
Apply	Click <b>Apply</b> to save the changes.
Cancel	Click <b>Cancel</b> to discard the changes.

## 19.6 Storm Control

Broadcast storm control limits the number of broadcast, multicast and destination lookup failure (DLF) packets the Switch receives per second on the ports. When the maximum number of allowable broadcast, multicast and/or DLF packets is reached per second, the subsequent packets are discarded. Enable this feature to reduce broadcast, multicast and/or DLF packets in your network. You can specify limits for each packet type on each port.

## 19.6.1 Port Settings

Use this screen to view Storm Control settings for individual ports. Click **Configuration > Port > Storm Control > Storm Control** to open this screen.

**Figure 142** Configuration > Port > Storm Control > Storm Control

Storm Control						
<input type="checkbox"/>	Port	State	Broadcast (pps)	Unknown Multicast (pps)	Unknown Unicast (pps)	Action
<input type="checkbox"/>	1	Disable	Disable	Disable	Disable	Drop
<input type="checkbox"/>	2	Disable	Disable	Disable	Disable	Drop
<input type="checkbox"/>	3	Disable	Disable	Disable	Disable	Drop
<input type="checkbox"/>	4	Disable	Disable	Disable	Disable	Drop
<input type="checkbox"/>	5	Disable	Disable	Disable	Disable	Drop
<input type="checkbox"/>	6	Disable	Disable	Disable	Disable	Drop
<input type="checkbox"/>	7	Disable	Disable	Disable	Disable	Drop
<input type="checkbox"/>	8	Disable	Disable	Disable	Disable	Drop
<input type="checkbox"/>	9	Disable	Disable	Disable	Disable	Drop
<input type="checkbox"/>	10	Disable	Disable	Disable	Disable	Drop
<input type="checkbox"/>	11	Disable	Disable	Disable	Disable	Drop
<input type="checkbox"/>	12	Disable	Disable	Disable	Disable	Drop
<input type="checkbox"/>	13	Disable	Disable	Disable	Disable	Drop
<input type="checkbox"/>	14	Disable	Disable	Disable	Disable	Drop
<input type="checkbox"/>	15	Disable	Disable	Disable	Disable	Drop
<input type="checkbox"/>	16	Disable	Disable	Disable	Disable	Drop
<input type="checkbox"/>	17	Disable	Disable	Disable	Disable	Drop
<input type="checkbox"/>	18	Disable	Disable	Disable	Disable	Drop
<input type="checkbox"/>	19	Disable	Disable	Disable	Disable	Drop
<input type="checkbox"/>	20	Disable	Disable	Disable	Disable	Drop
<input type="checkbox"/>	21	Disable	Disable	Disable	Disable	Drop
<input type="checkbox"/>	22	Disable	Disable	Disable	Disable	Drop
<input type="checkbox"/>	23	Disable	Disable	Disable	Disable	Drop
<input type="checkbox"/>	24	Disable	Disable	Disable	Disable	Drop
<input type="checkbox"/>	25	Disable	Disable	Disable	Disable	Drop
<input type="checkbox"/>	26	Disable	Disable	Disable	Disable	Drop

The following table describes the labels in this screen.

**Table 75** Configuration > Port > Storm Control > Storm Control

LABEL	DESCRIPTION
Storm Control	
Port	Displays the port index number.
State	Displays whether the traffic storm control on the Switch is enabled or disabled.
Broadcast (pps)	Displays how many broadcast packets the port receives per second.
Unknown Multicast (pps)	Displays how many multicast packets the port receives per second.
Unknown Unicast (pps)	Displays how many unicast packets the port receives per second.
Action	Displays the action the device takes when a limit is reached. The following options are available: <ul style="list-style-type: none"> <li><b>Drop</b> – drop the packet.</li> <li><b>Shutdown</b> – shutdown the connection.</li> </ul>
Edit	Select this check box to configure the properties of a port. Click the <b>Edit</b> button change the properties of the port.
Cancel	Click <b>Cancel</b> to discard the changes.

## 19.6.2 Port Edit

Use this screen to configure Storm Control settings for individual ports. Click **Configuration > Port > Storm Control > Storm Control > Edit** to open this screen.



**Figure 143** Configuration > Port > Storm Control > Storm Control > Edit

Storm Control Port			
Port List			
State	<input type="radio"/> Enable <input checked="" type="radio"/> Disable		
Action	<input checked="" type="radio"/> Drop <input type="radio"/> Shutdown		
Broadcast	<input type="checkbox"/> Enable	10000	(unit:pps)
Unknown Multicast	<input type="checkbox"/> Enable	10000	(unit:pps)
Unknown Unicast	<input type="checkbox"/> Enable	10000	(unit:pps)
<input type="button" value="Apply"/> <input type="button" value="Cancel"/>			

The following table describes the labels in this screen.

**Table 76** Configuration > Port > Storm Control > Storm Control > Edit

LABEL	DESCRIPTION
Storm Control Port	
Port List	Displays the port list index numbers.
State	Select <b>Enable</b> to activate traffic storm control on the ports.
Action	Determines the action the device takes when a limit is reached. The following options are available: <ul style="list-style-type: none"> <li>• <b>Drop</b> – drop the packet when limit is reached.</li> <li>• <b>Shutdown</b> – shutdown the connection when a limit is reached.</li> </ul>
Broadcast (pps)	Click the <b>Enable</b> checkbox to activate the feature. Enter the maximum number of broadcast packets the port can receive per second.
Unknown Multicast (pps)	Click the <b>Enable</b> checkbox to activate the feature. Enter the maximum number of multicast packets the port can receive per second.
Unknown Unicast (pps)	Click the <b>Enable</b> checkbox to activate the feature. Enter the maximum number of unicast packets the port can receive per second.
Apply	Click <b>Apply</b> to save the changes.
Cancel	Click <b>Cancel</b> to discard the changes.

# CHAPTER 20

## Configuration: VLAN

### 20.1 Overview

This section provides information for **VLAN** in **Configuration**.

A VLAN (Virtual Local Area Network) allows a physical network to be partitioned into multiple logical networks. Devices on a logical network belong to one group. A device can belong to more than one group. With VLAN, a device cannot directly talk to or hear from devices that are not in the same groups; the traffic must first go through a router.

In MTU (Multi-Tenant Unit) applications, VLAN is vital in providing isolation and security among the subscribers. When properly configured, VLAN prevents one subscriber from accessing the network resources of another on the same LAN, therefore a user will not see the printers and hard disks of another user on the same network.

VLAN also increases network performance by limiting broadcasts to a smaller and more manageable logical broadcast domain. In traditional switched environments, all broadcast packets go to each and every individual port. With VLAN, all broadcasts are confined to a specific broadcast domain.

#### 20.1.1 What You Can Do in this Chapter

- The **VLAN** screen ([Section 20.2 on page 139](#)) displays VLAN, port, and VLAN port settings.
- The **Guest VLAN** screen ([Section 20.3 on page 143](#)) displays the global and port settings of the Switch.
- The **Voice VLAN** screen ([Section 20.4 on page 145](#)) displays the global, OUI, and port settings of the Switch.

## 20.2 VLAN Settings

Use this screen to view and configure VLAN settings.

### 20.2.1 VLAN

Use this screen to view VLAN settings. Click **Configuration > VLAN > VLAN > VLAN** to open this screen.

**Figure 144** Configuration > VLAN > VLAN > VLAN

VLAN			<a href="#">VLAN</a>	<a href="#">Port</a>	<a href="#">VLAN Port</a>
VLAN ID	VLAN Name	VLAN Type	Action		
1	default	Default			

[Add](#)

The following table describes the labels in this screen.

**Table 77** Configuration > VLAN > VLAN > VLAN

LABEL	DESCRIPTION
VLAN	
VLAN ID	Displays the VLAN ID number.
VLAN Name	Displays a descriptive name for the VLAN group for identification purposes. This name consists of up to 64 printable characters; spaces are allowed.
VLAN Type	Displays <b>Default</b> or <b>Static</b> .
Action	
Edit	Click <b>Edit</b> to make changes to the entry.
Add	Click <b>Add</b> to create a new VLAN entry.

### 20.2.2 VLAN Add

Use this screen to add a VLAN. Click **Configuration > VLAN > VLAN > VLAN > Add** to open this screen.

**Figure 145** Configuration > VLAN > VLAN > VLAN > Add

VLAN		<a href="#">VLAN</a>	<a href="#">Port</a>	<a href="#">VLAN Port</a>
VLAN List	<input type="text"/>			
VLAN Name Prefix	<input type="text"/>			

[Apply](#) [Cancel](#)

The following table describes the labels in this screen.

**Table 78** Configuration > VLAN > VLAN > VLAN > Add

LABEL	DESCRIPTION
VLAN	
VLAN List	Enter the VLAN ID numbers.  Use a dash to associate consecutive VLANs and a comma (no spaces) to associate non-consecutive VLANs. For example, 51–53 includes 51, 52 and 53, but 51,53 does not include 52.

Table 78 Configuration &gt; VLAN &gt; VLAN &gt; VLAN &gt; Add (continued)

LABEL	DESCRIPTION
VLAN Name Prefix	Enter a prefix for the VLAN name.
Apply	Click <b>Apply</b> to save the changes.
Cancel	Click <b>Cancel</b> to discard the changes.

## 20.2.3 Port Settings

Use this screen to view port settings and select VLANs for configuration. Click **Configuration > VLAN > VLAN > Port** to open this screen.

Figure 146 Configuration &gt; VLAN &gt; VLAN &gt; Port

Port						VLAN Port	VLAN Port
<input type="checkbox"/>	Port	PVID	Accept Frame Type	Ingress Check	VLAN Trunk		
<input type="checkbox"/>	1	1	ALL	Disable	Disable		
<input type="checkbox"/>	2	1	ALL	Disable	Disable		
<input type="checkbox"/>	3	1	ALL	Disable	Disable		
<input type="checkbox"/>	4	1	ALL	Disable	Disable		
<input type="checkbox"/>	5	1	ALL	Disable	Disable		
<input type="checkbox"/>	6	1	ALL	Disable	Disable		
<input type="checkbox"/>	7	1	ALL	Disable	Disable		
<input type="checkbox"/>	25	1	ALL	Disable	Disable		
<input type="checkbox"/>	26	1	ALL	Disable	Disable		
<input type="checkbox"/>	LAG1	1	ALL	Disable	Disable		
<input type="checkbox"/>	LAG2	1	ALL	Disable	Disable		
<input type="checkbox"/>	LAG3	1	ALL	Disable	Disable		
<input type="checkbox"/>	LAG4	1	ALL	Disable	Disable		
<input type="checkbox"/>	LAG5	1	ALL	Disable	Disable		
<input type="checkbox"/>	LAG6	1	ALL	Disable	Disable		
<input type="checkbox"/>	LAG7	1	ALL	Disable	Disable		
<input type="checkbox"/>	LAG8	1	ALL	Disable	Disable		

[Edit](#) [Cancel](#)

The following table describes the labels in this screen.

Table 79 Configuration &gt; VLAN &gt; VLAN &gt; Port

LABEL	DESCRIPTION
Port	
Port	Displays the port index number.
PVID	A PVID (Port VLAN ID) is a tag that adds to incoming untagged frames received on a port so that the frames are forwarded to the VLAN group that the tag defines.
Accept Frame Type	Specify the type of frames allowed on a port. Choices are <b>All</b> , <b>Tag Only</b> and <b>Untag Only</b> .
Ingress Check	If this check box is selected for a port, the Switch discards incoming frames for VLANs that do not include this port in its member set.
VLAN Trunk	Enable VLAN Trunking on ports connected to other switches or routers (but not ports directly connected to end users) to allow frames belonging to unknown VLAN groups to pass through the Switch.

Table 79 Configuration &gt; VLAN &gt; VLAN &gt; Port (continued)

LABEL	DESCRIPTION
Edit	Select this check box to configure the properties of a port. Click the <b>Edit</b> button change the properties of the port.
Cancel	Click <b>Cancel</b> to discard the changes.

## 20.2.4 Port Edit

Use this screen to configure port settings. Click **Configuration > VLAN > VLAN > Port > Edit** to open this screen.

Figure 147 Configuration &gt; VLAN &gt; VLAN &gt; Port &gt; Edit

The following table describes the labels in this screen.

Table 80 Configuration &gt; VLAN &gt; VLAN &gt; Port &gt; Edit

LABEL	DESCRIPTION
Port	
Port Select	Displays the list of port index numbers that are being configured.
PVID	Enter a number between 1 and 4094 as the port VLAN ID.
Accepted Type	Select <b>All</b> from the drop-down list box to accept all untagged or tagged frames on this port. This is the default setting.  Select <b>Tag Only</b> to accept only tagged frames on this port. All untagged frames will be dropped.  Select <b>Untag Only</b> to accept only untagged frames on this port. All tagged frames will be dropped.
Ingress Filtering	If this check box is selected for a port, the Switch discards incoming frames for VLANs that do not include this port in its member set.  Clear this check box to disable ingress filtering.
VLAN Trunk	Enable VLAN Trunking on ports connected to other switches or routers (but not ports directly connected to end users) to allow frames belonging to unknown VLAN groups to pass through the Switch.
Apply	Click <b>Apply</b> to save the changes.
Cancel	Click <b>Cancel</b> to discard the changes.

## 20.2.5 VLAN Port

Port-based VLANs are VLANs where the packet forwarding decision is based on the destination MAC address and its associated port. Port-based VLANs require allowed outgoing ports to be defined for each port. Therefore, if you wish to allow two subscriber ports to talk to each other, for example,

between conference rooms in a hotel, you must define the egress (an egress port is an outgoing port, that is, a port through which a data packet leaves) for both ports. Port-based VLANs are specific only to the Switch on which they were created.

Use this screen to view VLAN port settings. Click **Configuration > VLAN > VLAN > VLAN Port** to open this screen.

**Figure 148** Configuration > VLAN > VLAN > VLAN Port

VLAN Port		<a href="#">VLAN</a> <a href="#">Port</a> <a href="#">VLAN Port</a>			
VLAN ID	1 ▼				
		Membership: Untagged ▼			
Port	Membership				
*	Untagged ▼				
1	<input type="radio"/> Forbidden	<input type="radio"/> Excluded	<input type="radio"/> Tagged	<input checked="" type="radio"/> Untagged	
2	<input type="radio"/> Forbidden	<input type="radio"/> Excluded	<input type="radio"/> Tagged	<input checked="" type="radio"/> Untagged	
3	<input type="radio"/> Forbidden	<input type="radio"/> Excluded	<input type="radio"/> Tagged	<input checked="" type="radio"/> Untagged	
4	<input type="radio"/> Forbidden	<input type="radio"/> Excluded	<input type="radio"/> Tagged	<input checked="" type="radio"/> Untagged	
5	<input type="radio"/> Forbidden	<input type="radio"/> Excluded	<input type="radio"/> Tagged	<input checked="" type="radio"/> Untagged	
6	<input type="radio"/> Forbidden	<input type="radio"/> Excluded	<input type="radio"/> Tagged	<input checked="" type="radio"/> Untagged	
7	<input type="radio"/> Forbidden	<input type="radio"/> Excluded	<input type="radio"/> Tagged	<input checked="" type="radio"/> Untagged	
25	<input type="radio"/> Forbidden	<input type="radio"/> Excluded	<input type="radio"/> Tagged	<input checked="" type="radio"/> Untagged	
26	<input type="radio"/> Forbidden	<input type="radio"/> Excluded	<input type="radio"/> Tagged	<input checked="" type="radio"/> Untagged	
LAG1	<input type="radio"/> Forbidden	<input type="radio"/> Excluded	<input type="radio"/> Tagged	<input checked="" type="radio"/> Untagged	
LAG2	<input type="radio"/> Forbidden	<input type="radio"/> Excluded	<input type="radio"/> Tagged	<input checked="" type="radio"/> Untagged	
LAG3	<input type="radio"/> Forbidden	<input type="radio"/> Excluded	<input type="radio"/> Tagged	<input checked="" type="radio"/> Untagged	
LAG4	<input type="radio"/> Forbidden	<input type="radio"/> Excluded	<input type="radio"/> Tagged	<input checked="" type="radio"/> Untagged	
LAG5	<input type="radio"/> Forbidden	<input type="radio"/> Excluded	<input type="radio"/> Tagged	<input checked="" type="radio"/> Untagged	
LAG6	<input type="radio"/> Forbidden	<input type="radio"/> Excluded	<input type="radio"/> Tagged	<input checked="" type="radio"/> Untagged	
LAG7	<input type="radio"/> Forbidden	<input type="radio"/> Excluded	<input type="radio"/> Tagged	<input checked="" type="radio"/> Untagged	
LAG8	<input type="radio"/> Forbidden	<input type="radio"/> Excluded	<input type="radio"/> Tagged	<input checked="" type="radio"/> Untagged	
<input type="button" value="Apply"/> <input type="button" value="Cancel"/>					

The following table describes the labels in this screen.

Table 81 Configuration > VLAN > VLAN > VLAN Port

LABEL	DESCRIPTION
VLAN Port	
VLAN ID	Select the ID of the VLAN you want to configure.
Port	Displays the port index value.
Membership	Select <b>Forbidden</b> if you want to prohibit the port from joining this VLAN group. Select <b>Excluded</b> to remove the port from the VLAN. Select <b>Tagged</b> to set the port TX tag status to tagged in the VLAN. Select <b>Untagged</b> to set the port TX tag status to untagged in the VLAN.
Apply	Click <b>Apply</b> to save the changes.
Cancel	Click <b>Cancel</b> to discard the changes.

## 20.3 Guest VLAN

When 802.1x port authentication is enabled on the Switch and its ports, clients that do not have the correct credentials are blocked from using the ports. You can configure your Switch to have one VLAN that acts as a guest VLAN. If you enable the guest VLAN (102 in the example) on a port (2 in the example), the user (A in the example) that is not IEEE 802.1x capable or fails to enter the correct user name and password can still access the port, but traffic from the user is forwarded to the guest VLAN. That is, unauthenticated users can have access to limited network resources in the same guest VLAN, such as the Internet. The rights granted to the Guest VLAN depends on how the network administrator configures switches or routers with the guest network feature.

**Figure 149** Guest VLAN Example

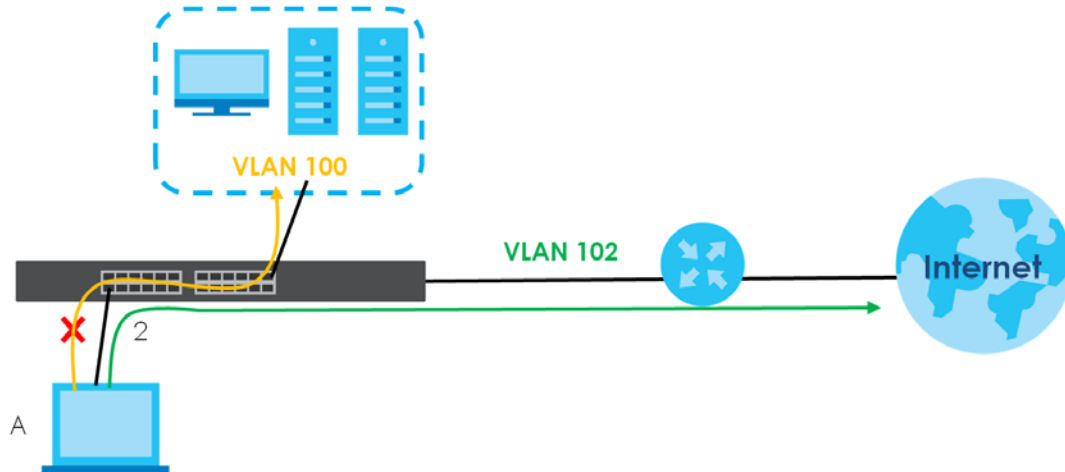

Use this screen to view and configure guest VLAN settings.

### 20.3.1 Global Settings

Use this screen to configure the global Guest VLAN settings. Click **Configuration > VLAN > Guest VLAN > Global** to open this screen.

**Figure 150** Configuration > VLAN > Guest VLAN > Global

Global		<a href="#">Global</a> <a href="#">Port</a>
State	<input type="radio"/> Enable <input checked="" type="radio"/> Disable	
Guest VLAN ID	<input type="text" value="0"/>	
<input type="button" value="Apply"/> <input type="button" value="Cancel"/>		

The following table describes the labels in this screen.

Table 82 Configuration > VLAN > Guest VLAN > Global

LABEL	DESCRIPTION
Global	
State	Select to enable the global Guest VLAN feature.
Guest VLAN ID	Enter the global guest VLAN ID.

Table 82 Configuration &gt; VLAN &gt; Guest VLAN &gt; Global (continued)

LABEL	DESCRIPTION
Apply	Click <b>Apply</b> to save the changes.
Cancel	Click <b>Cancel</b> to discard the changes.

## 20.3.2 Port Settings

Use this screen to view the Guest VLAN port settings and select VLAN ports for configuration. Click **Configuration > VLAN > Guest VLAN > Port** to open this screen.

Figure 151 Configuration &gt; VLAN &gt; Guest VLAN &gt; Port

Port	State
<input type="checkbox"/> 1	Disable
<input type="checkbox"/> 2	Disable
<input type="checkbox"/> 3	Disable
<input type="checkbox"/> 4	Disable
<input type="checkbox"/> 5	Disable
<input type="checkbox"/> 6	Disable
<input type="checkbox"/> 7	Disable
<input type="checkbox"/> 21	Disable
<input type="checkbox"/> 22	Disable
<input type="checkbox"/> 23	Disable
<input type="checkbox"/> 24	Disable
<input type="checkbox"/> 25	Disable
<input type="checkbox"/> 26	Disable

The following table describes the labels in this screen.

Table 83 Configuration &gt; VLAN &gt; Guest VLAN &gt; Port

LABEL	DESCRIPTION
Port	
Port	Displays the port index number.
State	Display the state of the selected port.
Edit	Select this check box to configure the properties of a port. Click the <b>Edit</b> button change the properties of the port.
Cancel	Click <b>Cancel</b> to discard the changes.

## 20.3.3 Port Edit

Use this screen to configure the guest VLAN port EEE settings. Click **Configuration > VLAN > Guest VLAN > Port > Edit** to open this screen.



**Figure 152** Configuration > VLAN > Guest VLAN > Port > Edit

The following table describes the labels in this screen.

Table 84 Configuration &gt; VLAN &gt; Guest VLAN &gt; Port &gt; Edit

LABEL	DESCRIPTION
Port	
Port List	Displays the list of port index numbers that are being configured.
State	Enable/Disable the guest VLAN feature.
Apply	Click <b>Apply</b> to save the changes.
Cancel	Click <b>Cancel</b> to discard the changes.

## 20.4 Voice VLAN

The Voice VLAN feature enables voice traffic forwarding on the Voice VLAN, then the switch can classify and schedule network traffic. It is recommended that there be two VLANs on a port – one for voice, one for data.

Use this screen to view and configure voice VLAN settings.

### 20.4.1 Global Settings

Use this screen to configure the global Voice VLAN settings. Click **Configuration > VLAN > Voice VLAN > Global** to open this screen.

**Figure 153** Configuration > VLAN > Voice VLAN > Global

The following table describes the labels in this screen.

Table 85 Configuration &gt; VLAN &gt; Voice VLAN &gt; Global

LABEL	DESCRIPTION
Global	
State	Select <b>Enable</b> to activate the global voice VLAN feature.

Table 85 Configuration &gt; VLAN &gt; Voice VLAN &gt; Global (continued)

LABEL	DESCRIPTION
Voice VLAN ID	Enter the global voice VLAN ID. It should be a unique VLAN ID in the system and cannot equal each port PVID. It is a conflict in configuration if the value equals management VID, MVR VID, PVID, and so on. The allowed range is 1 to 4094.
Cos/802.1p	Displays the 802.1p packet priority field.
Remark Cos/802.1p	Select to <b>Enable</b> the priority remark function for cos/802.1p.
Aging Time	Enter the voice VLAN secure learning aging time. The allowed range is 10 to 10000000 seconds. It is used when security mode or auto detect mode is enabled. In other cases, it will be based on hardware aging time. The actual aging time will be situated between the [age_time; 2 * age_time] interval.
Apply	Click <b>Apply</b> to save the changes.
Cancel	Click <b>Cancel</b> to discard the changes.

## 20.4.2 OUI Settings

Use this screen to view the OUI settings. The maximum number of entries is 16. Modifying the OUI table will restart auto detection of OUI process. Click **Configuration > VLAN > Voice VLAN > OUI** to open this screen.

Figure 154 Configuration &gt; VLAN &gt; Voice VLAN &gt; OUI

OUI		Global	OUI	Port
OUI Address	Description	Action		
00:E0:BB	3COM			
00:03:6B	Cisco			
00:E0:75	Veritel			
00:D0:1E	Pingtel			
00:01:E3	Siemens			
00:60:B9	NEC/Philips			
00:0F:E2	H3C			
00:09:6E	Avaya			

[Add](#)

The following table describes the labels in this screen.

Table 86 Configuration &gt; VLAN &gt; Voice VLAN &gt; OUI

LABEL	DESCRIPTION
OUI	
OUI Address	Displays an OUI address. A telephony OUI address is a globally unique identifier assigned to a vendor by IEEE. It must be 6 characters long and the input format is "xx-xx-xx" (x is a hexadecimal digit).
Description	Displays a description of the OUI address. Normally, it describes which vendor telephony device it belongs to. The allowed string length is 0 to 32.
Action	
Edit	Click <b>Edit</b> to make changes to the entry.
Delete	Click <b>Delete</b> to remove the entry.
Add	Click <b>Add</b> to create a new OUI entry.

### 20.4.3 OUI Add or Edit

Use this screen to add or edit an OUI address. Click **Configuration > VLAN > Voice VLAN > OUI > Add or Edit** to open this screen.

**Figure 155** Configuration > VLAN > Voice VLAN > OUI > Add or Edit

Add OUI		Global	OUI	Port
OUI Address	00:00:00			
Description	OUI			
<input type="button" value="Apply"/> <input type="button" value="Cancel"/>				

The following table describes the labels in this screen.

**Table 87** Configuration > VLAN > Voice VLAN > OUI > Add or Edit

LABEL	DESCRIPTION
Add/Edit OUI	
OUI Address	Enter an OUI address. A telephony OUI address is a globally unique identifier assigned to a vendor by IEEE. It must be 6 characters long and the input format is "xx-xx-xx" (x is a hexadecimal digit).
Description	Enter a description of the OUI address. Normally, it describes which vendor telephony device it belongs to. The allowed string length is 0 to 32.
Apply	Click <b>Apply</b> to save the changes.
Cancel	Click <b>Cancel</b> to discard the changes.

### 20.4.4 Port Settings

Use this screen to view the Voice VLAN port settings and select a port for configuration. Click **Configuration > VLAN > Voice VLAN > Port** to open this screen.

**Figure 156** Configuration > VLAN > Voice VLAN > Port

Port		Global	OUI	Port
<input type="checkbox"/>	Port	State		
<input type="checkbox"/>	1	Disable		
<input type="checkbox"/>	2	Disable		
<input type="checkbox"/>	3	Disable		
<input type="checkbox"/>	4	Disable		
<input type="checkbox"/>	5	Disable		
<input type="checkbox"/>	6	Disable		
<input type="checkbox"/>	7	Disable		
<input type="checkbox"/>	21	Disable		
<input type="checkbox"/>	22	Disable		
<input type="checkbox"/>	23	Disable		
<input type="checkbox"/>	24	Disable		
<input type="checkbox"/>	25	Disable		
<input type="checkbox"/>	26	Disable		
<input type="button" value="Edit"/> <input type="button" value="Cancel"/>				

The following table describes the labels in this screen.

Table 88 Configuration > VLAN > Voice VLAN > Port

LABEL	DESCRIPTION
Port	
Port	Displays the port index value.
State	Displays the Voice VLAN port security mode state. When the function is enabled, all non-telephonic MAC addresses in the Voice VLAN will be blocked for 10 seconds. Possible port modes are: <ul style="list-style-type: none"> <li><b>Enabled:</b> Enable Voice VLAN security mode operation.</li> <li><b>Disabled:</b> Disable Voice VLAN security mode operation.</li> </ul>
Edit	Select this check box to configure the properties of a port. Click the <b>Edit</b> button change the properties of the port.
Cancel	Click <b>Cancel</b> to discard the changes.

## 20.4.5 Port Edit

Use this screen to edit the ports security state. Click **Configuration > VLAN > Voice VLAN > Port > Edit** to open this screen.

Figure 157 Configuration > VLAN > Voice VLAN > Port > Edit

The following table describes the labels in this screen.

Table 89 Configuration > VLAN > Voice VLAN > Port > Edit

LABEL	DESCRIPTION
Port	
Port	Displays the ports index value.
State	Select the Voice VLAN port security mode state. When the function is enabled, all non-telephonic MAC addresses in the Voice VLAN will be blocked for 10 seconds. Possible port modes are: <ul style="list-style-type: none"> <li><b>Enabled:</b> Enable Voice VLAN security mode operation.</li> <li><b>Disabled:</b> Disable Voice VLAN security mode operation.</li> </ul>
Apply	Click <b>Apply</b> to save the changes.
Cancel	Click <b>Cancel</b> to discard the changes.

# CHAPTER 21

## Configuration: MAC Table

### 21.1 Overview

This section provides information for **MAC Table** in **Configuration**.

The **MAC Table** screen (a MAC table is also known as a filtering database) shows how frames are forwarded or filtered across the Switch's ports. When a device (which may belong to a VLAN group) sends a packet which is forwarded to a port on the Switch, the MAC address of the device is shown on the Switch's **MAC Table**. It also shows whether the MAC address is dynamic (learned by the Switch) or static (manually entered in the **Static MAC Forwarding** screen).

#### 21.1.1 What You Can Do in this Chapter

The **MAC Table** screen displays Static MAC, Filtering MAC, and Dynamic MAC settings.

#### 21.1.2 Static MAC

Use this screen to view Static MAC addresses settings. Click **Configuration > MAC Table > Static MAC** to open this screen.

**Figure 158** Configuration > MAC Table > Static MAC

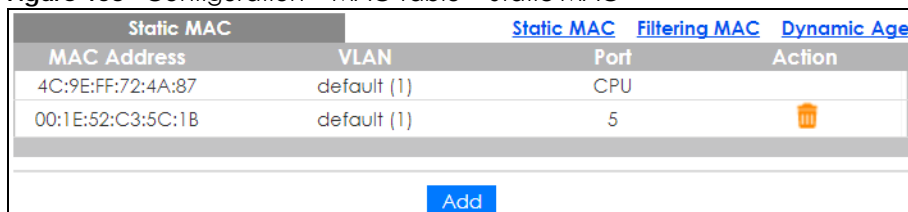

Static MAC		Static MAC	Filtering MAC	Dynamic Age
MAC Address	VLAN	Port	Action	
4C:9E:FF:72:4A:87	default (1)	CPU		
00:1E:52:C3:5C:1B	default (1)	5		

[Add](#)

The following table describes the labels in this screen.

Table 90 Configuration > MAC Table > Static MAC

LABEL	DESCRIPTION
Static MAC	
MAC Address	Displays the object MAC address from which this incoming frame came.
VLAN	Displays the VLAN group to which this frame belongs.
Port	Displays the port from which the above MAC address was learned.
Action	Click <b>Delete</b> to remove the MAC address.
Add	Click <b>Add</b> to create a new <b>Static MAC</b> entry.

### 21.1.3 Static MAC Address

Use this screen to add new Static MAC addresses. Click **Configuration > MAC Table > Static MAC > Add** to open this screen.

**Figure 159** Configuration > MAC Table > Static MAC > Add

The following table describes the labels in this screen.

Table 91 Configuration > MAC Table > Static MAC > Add

LABEL	DESCRIPTION
Static MAC	
MAC Address	Enter the object MAC address.
VLAN	Select the VLAN group which to associate the MAC address.
Port	Select the port which to associate the above MAC address.
Apply	Click <b>Apply</b> to save the changes.
Cancel	Click <b>Cancel</b> to discard the changes.

### 21.1.4 Filtering MAC Address

Use this screen to view Filtering MAC addresses. Click **Configuration > MAC Table > Filtering MAC** to open this screen.

**Figure 160** Configuration > MAC Table > Filtering MAC

The following table describes the labels in this screen.

Table 92 Configuration > MAC Table > Filtering MAC

LABEL	DESCRIPTION
Filtering MAC	
MAC Address	Displays the filtering object MAC address from which this incoming frame came.
VLAN	Displays the VLAN group to which this frame belongs.
Action	
Delete	Click <b>Delete</b> to remove the entry.
Add	Click <b>Add</b> to create a new <b>Filtering MAC</b> entry.

## 21.1.5 Filtering MAC Address (Add)

Use this screen to add new Filtering MAC addresses. Click **Configuration > MAC Table > Filtering MAC > Add** to open this screen.

**Figure 161** Configuration > MAC Table > Filtering MAC > Add

Add Filtering MAC		<a href="#">Static MAC</a>	<a href="#">Filtering MAC</a>	<a href="#">Dynamic Age</a>
MAC Address	00:00:00:00:00:00			
VLAN	1			
<input type="button" value="Apply"/> <input type="button" value="Cancel"/>				

The following table describes the labels in this screen.

Table 93 Configuration > MAC Table > Filtering MAC > Add

LABEL	DESCRIPTION
Add Filtering MAC	
MAC Address	Enter the MAC address of the device.
VLAN	Select the VLAN group to associate the filtering object MAC address.
Apply	Click <b>Apply</b> to save the changes.
Cancel	Click <b>Cancel</b> to discard the changes.

## 21.1.6 Dynamic Age

Use this screen to enter the Dynamic MAC Age. The dynamic MAC age is how long all dynamically learned MAC addresses remain in the MAC address table before they age out (and must be relearned). Click **Configuration > MAC Table > Dynamic Age** to open this screen.

**Figure 162** Configuration > MAC Table > Dynamic Age

Dynamic MAC Age		<a href="#">Static MAC</a>	<a href="#">Filtering MAC</a>	<a href="#">Dynamic Age</a>
Aging Time	300	(10 - 630 sec)		
<input type="button" value="Apply"/> <input type="button" value="Cancel"/>				

The following table describes the labels in this screen.

Table 94 Configuration > MAC Table > Dynamic Age

LABEL	DESCRIPTION
Dynamic MAC Age	
Aging Time	Enter the aging time of the MAC address. The value can be between 10 and 630 seconds.
Apply	Click <b>Apply</b> to save the changes.
Cancel	Click <b>Cancel</b> to discard the changes.

# CHAPTER 22

# Configuration: Link Aggregation

## 22.1 Overview

This section provides information for **Link Aggregation** in **Configuration**.

This chapter shows you how to logically aggregate physical links to form one logical, higher bandwidth link.

### 22.1.1 What You Can Do in this Chapter

The **Link Aggregation** screen ([Section 22.2 on page 152](#)) displays global, LAG management, LAG port, and LACP port settings.

## 22.2 Link Aggregation

Link aggregation (trunking) is the grouping of physical ports into one logical higher-capacity link. You may want to trunk ports if for example, it is cheaper to use multiple lower-speed links than to under-utilize a high-speed, but more costly, single-port link.

However, the more ports you aggregate then the fewer available ports you have. A trunk group is one logical link containing multiple ports.

The Switch supports both static and dynamic link aggregation.

Note: In a properly planned network, it is recommended to implement static link aggregation only. This ensures increased network stability and control over the trunk groups on your Switch.

### 22.2.1 Global Settings

Use this screen to configure global Link Aggregation settings. Click **Configuration > Link Aggregation > Global** to open this screen.



**Figure 163** Configuration > Link Aggregation > Global

Global		Global	LAG Management	LAG Port	LACP Port
LACP State	<input type="radio"/> Enable <input checked="" type="radio"/> Disable				
LACP System Priority	65535	(1-65535)			
Load Balance Algorithm	<input type="radio"/> MAC Address <input checked="" type="radio"/> IP/MAC Address				
<input type="button" value="Apply"/> <input type="button" value="Cancel"/>					

The following table describes the labels in this screen.

Table 95 Configuration &gt; Link Aggregation &gt; Global

LABEL	DESCRIPTION
Global	
LACP State	Select <b>Enable</b> to activate the link aggregation control protocol.
LACP System Priority	LACP system priority is a number between 1 and 65,535. The switch with the lowest system priority (and lowest port number if system priority is the same) becomes the LACP "server". The LACP "server" controls the operation of LACP setup. Enter a number to set the priority of an active port using Link Aggregation Control Protocol (LACP). The smaller the number, the higher the priority level.
Load Balance Algorithm	Select the outgoing traffic distribution type. Packets from the same source and/or to the same destination are sent over the same link within the trunk. By default, the Switch uses the <b>IP/MAC Address</b> distribution type. If the Switch is behind a router, the packet's destination or source MAC address will be changed. In this case, set the Switch to distribute traffic based on its IP address to make sure port trunking can work properly.  Select <b>MAC Address</b> to distribute traffic based on a combination of the packet's source and destination MAC addresses.  Select <b>IP/MAC Address</b> to distribute traffic based on a combination of the packet's source and destination IP addresses.
Apply	Click <b>Apply</b> to save the changes.
Cancel	Click <b>Cancel</b> to discard the changes.

## 22.2.2 LAG Management

Use this screen to view LAG management settings. Click **Configuration > Link Aggregation > LAG Management** to open this screen.

**Figure 164** Configuration > Link Aggregation > LAG Management

LAG Management		Global	LAG Management	LAG Port	LACP Port	
LAG	Name	Type	Link Status	Active Member	Standby Member	Action
<input type="button" value="Add"/>						

The following table describes the labels in this screen.

Table 96 Configuration &gt; Link Aggregation &gt; LAG Management

LABEL	DESCRIPTION
LAG Management	
LAG	Displays the link aggregation group (LAG), that is, one logical link containing multiple ports.
Name	Displays the name of the link aggregation group.

Table 96 Configuration &gt; Link Aggregation &gt; LAG Management (continued)

LABEL	DESCRIPTION
Type	This field displays how these ports were added to the trunk group. It displays: <b>Static</b> – if the ports are configured as static members of a trunk group. <b>LACP</b> – if the ports are configured to join a trunk group through LACP.
Link Status	Displays link status as either <b>Link up</b> or <b>Link down</b> .
Active Member	Displays if this member is an active member of a trunk.
Standby Member	Displays if this member is a standby member of a trunk.
Action	
Edit	Click <b>Edit</b> to make changes to the entry.
Delete	Click <b>Delete</b> to remove the entry.
Add	Click <b>Add</b> to create a new <b>LAG Management</b> entry.

### 22.2.3 LAG Management (Add)

Use this screen to add a LAG. Click **Configuration > Link Aggregation > LAG Management > Add** to open this screen.

Figure 165 Configuration &gt; Link Aggregation &gt; LAG Management &gt; Add

The following table describes the labels in this screen.

Table 97 Configuration &gt; Link Aggregation &gt; LAG Management &gt; Add

LABEL	DESCRIPTION
LAG Management	
LAG	Select the link aggregation group (LAG).
Name	Enter the name of this entry.
Type	Select <b>Static</b> or <b>LACP</b> .
Member Ports	Select the member ports to be part of the LAG.

Table 97 Configuration &gt; Link Aggregation &gt; LAG Management &gt; Add (continued)

LABEL	DESCRIPTION
Apply	Click <b>Apply</b> to save the changes.
Cancel	Click <b>Cancel</b> to discard the changes.

## 22.2.4 LAG Port

Use this screen to view LAG port settings. Click **Configuration > Link Aggregation > LAG Port** to open this screen.

Figure 166 Configuration &gt; Link Aggregation &gt; LAG Port

LAG Port		Global	LAG Management	LAG Port	LACP Port			
<input type="checkbox"/>	LAG	Name	Port Type	State	Speed	Duplex	FlowCtrl State	FlowCtrl Status
<input type="checkbox"/>	LAG1			Enable	Auto	Auto	Disable	Disable
<input type="checkbox"/>	LAG2			Enable	Auto	Auto	Disable	Disable
<input type="checkbox"/>	LAG3			Enable	Auto	Auto	Disable	Disable
<input type="checkbox"/>	LAG4			Enable	Auto	Auto	Disable	Disable
<input type="checkbox"/>	LAG5			Enable	Auto	Auto	Disable	Disable
<input type="checkbox"/>	LAG6			Enable	Auto	Auto	Disable	Disable
<input type="checkbox"/>	LAG7			Enable	Auto	Auto	Disable	Disable
<input type="checkbox"/>	LAG8			Enable	Auto	Auto	Disable	Disable

The following table describes the labels in this screen.

Table 98 Configuration &gt; Link Aggregation &gt; LAG Port

LABEL	DESCRIPTION
LAG Port	
LAG	Displays the LAG index value.
Name	Displays the LAG name.
Port Type	Displays the port type.
State	Displays the state as <b>Enable</b> or <b>Disable</b> .
Speed	Displays the speed value as <b>Auto</b> , <b>Auto-10M</b> , <b>Auto-100M</b> , <b>Auto-1000M</b> , <b>Auto-10/100M</b> , <b>10M</b> , <b>100M</b> , or <b>1000M</b> .
Duplex	Displays the duplex value as <b>Full</b> , <b>Half</b> , or <b>Auto</b> .
FlowCtrl State	Displays whether flow control is <b>Enable</b> or <b>Disable</b> .
FlowCtrl Status	Displays whether flow control is in use ( <b>Enable</b> ) or not ( <b>Disable</b> ).
Edit	Select this check box to configure the properties of a port. Click the <b>Edit</b> button change the properties of the port.
Cancel	Click <b>Cancel</b> to discard the changes.

## 22.2.5 LAG Port Edit

Use this screen to edit a LAG port. Click **Configuration > Link Aggregation > LAG Port > Edit** to open this screen.

**Figure 167** Configuration > Link Aggregation > LAG Port > Edit

The following table describes the labels in this screen.

**Table 99** Configuration > Link Aggregation > LAG Port > Edit

LABEL	DESCRIPTION
LAG Port	
LAG	Displays the LAG index values.
State	Select the state to be <b>Enable</b> or <b>Disable</b> .
Speed	Displays the speed value as <b>Auto</b> , <b>10M</b> , <b>100M</b> , or <b>1000M</b> .
Flow Control	Select <b>Enable</b> to use the flow control feature.
Apply	Click <b>Apply</b> to save the changes.
Cancel	Click <b>Cancel</b> to discard the changes.

## 22.2.6 LACP Port

Use this screen to view LACP Port settings. Click **Configuration > Link Aggregation > LACP Port** to open this screen.

**Figure 168** Configuration > Link Aggregation > LACP Port

Port	Priority	Timer(sec)
1	1	30
2	1	30
3	1	30
4	1	30
5	1	30
6	1	30
7	1	30
8	1	30
22	1	30
23	1	30
24	1	30
25	1	30
26	1	30

The following table describes the labels in this screen.

Table 100 Configuration > Link Aggregation > LACP Port

LABEL	DESCRIPTION
LACP Port	
Port	Displays the port index number.
Priority	Displays the priority value.
Timer (sec)	Displays the Timer value in seconds.  Timeout is the time interval between the individual port exchanges of LACP packets in order to check that the peer port in the trunk group is still up. If a port does not respond after three tries, then it is deemed to be "down" and is removed from the trunk. Set a short timeout (one second) for busy trunked links to ensure that disabled ports are removed from the trunk group as soon as possible.
Edit	Select this check box to configure the properties of a port. Click the <b>Edit</b> button change the properties of the port.
Cancel	Click <b>Cancel</b> to discard the changes.

## 22.2.7 LACP Port Edit

Use this screen to edit a LACP Port. Click **Configuration > Link Aggregation > LACP Port > Edit** to open this screen.

Figure 169 Configuration > Link Aggregation > LACP Port > Edit

The following table describes the labels in this screen.

Table 101 Configuration > Link Aggregation > LACP Port > Edit

LABEL	DESCRIPTION
LACP Port	
Port List	Displays the list of port index numbers to be configured.
Priority	Enter a value for the port priority. The number can be between 1 and 65,535.
Timer	Select a timer value of either 1 second or 30 seconds.
Apply	Click <b>Apply</b> to save the changes.
Cancel	Click <b>Cancel</b> to discard the changes.

# CHAPTER 23

## Configuration: Loop Guard

### 23.1 Overview

This section provides information for **Loop Guard** in **Configuration**.

This chapter shows you how to configure the Switch to guard against loops on the edge of your network.

### 23.2 Loop Guard

Loop guard allows you to configure the Switch to shut down a port if it detects that packets sent out on that port loop back to the Switch. While you can use Spanning Tree Protocol (STP) to prevent loops in the core of your network, STP cannot prevent loops that occur on the edge of your network.

#### 23.2.1 Global Settings

Use this screen to configure the global Loop Guard. Click **Configuration** > **Loop Guard** > **Global** to open this screen.

**Figure 170** Configuration > Loop Guard > Global

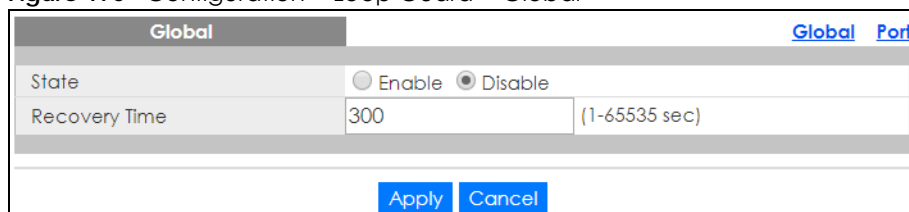

Global		Global	Port
State	<input type="radio"/> Enable <input checked="" type="radio"/> Disable		
Recovery Time	300	(1-65535 sec)	
<input type="button" value="Apply"/> <input type="button" value="Cancel"/>			

The following table describes the labels in this screen.

Table 102 Configuration > Loop Guard > Global

LABEL	DESCRIPTION
Global	
State	Select <b>Enable</b> to activate loop protection on this Switch.
Recovery Time	Enter the period (in seconds) for which a port will be kept disabled in the event of a loop is detected (and the port action shuts down the port).
Apply	Click <b>Apply</b> to save the changes.
Cancel	Click <b>Cancel</b> to discard the changes.

## 23.2.2 Loop Guard Port

Use this screen to view the port's Loop Guard settings. Click **Configuration > Loop Guard > Port** to open this screen.

**Figure 171** Configuration > Loop Guard > Port

Port	State	Action
1	Disable	Shutdown Port
2	Disable	Shutdown Port
3	Disable	Shutdown Port
4	Disable	Shutdown Port
5	Disable	Shutdown Port
6	Disable	Shutdown Port
7	Disable	Shutdown Port
22	Disable	Shutdown Port
23	Disable	Shutdown Port
24	Disable	Shutdown Port
25	Disable	Shutdown Port
26	Disable	Shutdown Port

The following table describes the labels in this screen.

Table 103 Configuration > Loop Guard > Port

LABEL	DESCRIPTION
Port	
Port	Displays the port index number.
State	Displays whether the loop guard feature is <b>Enable</b> or <b>Disable</b> on the port.
Action	Displays the action to take by the Switch. The options are <b>Log</b> , <b>Shutdown Port</b> , and <b>Shutdown and Log</b> .
Edit	Select this check box to configure the properties of a port. Click the <b>Edit</b> button change the properties of the port.
Cancel	Click <b>Cancel</b> to discard the changes.

## 23.2.3 Port Edit

Use this screen to configure Loop Guard settings on a port. Click **Configuration > Loop Guard > Port > Edit** to open this screen.

**Figure 172** Configuration > Loop Guard > Port > Edit

The following table describes the labels in this screen.

Table 104 Configuration > Loop Guard > Port > Edit

LABEL	DESCRIPTION
Port	
Port List	Displays the list of port index numbers to be configured.
State	Select to enable or disable the loop guard feature on the port.
Action	Select to have the Switch shut down a port and/or generate a log message if it detects that packets sent out on that port loop back to the Switch.
Apply	Click <b>Apply</b> to save the changes.
Cancel	Click <b>Cancel</b> to discard the changes.



# CHAPTER 24

## Configuration: Mirror

### 24.1 Overview

This section provides information for **Mirror** in **Configuration**.

### 24.2 Mirror Settings

Port mirroring allows you to copy a traffic flow to a monitor port (the port you copy the traffic to) in order that you can examine the traffic from the monitor port without interference.

The Switch supports local port mirroring.

#### 24.2.1 Mirror

Use this screen to configure Mirroring. Click **Configuration** > **Mirror** to open this screen.

Figure 173 Configuration &gt; Mirror

The following table describes the labels in this screen.

Table 105 Configuration &gt; Mirror

LABEL	DESCRIPTION
Mirror	
Mirroring	Select <b>Enable</b> to activate port mirroring on the Switch or <b>Disable</b> to disable the feature.
Monitor Port	The monitor port is the port you copy the traffic to in order to examine it in more detail without interfering with the traffic flow on the original ports. Type the port number of the monitor port.
Egress	Specify the ports to mirror outgoing traffic.
Available	Click < to move a severity type from the acting box to the available box. Click > to move a severity type to the acting box from the available box.
Acting	Click < to move a severity type from the acting box to the available box. Click > to move a severity type to the acting box from the available box.
>	Click > to move a severity type to the acting box from the available box.
<	Click < to move a severity type from the acting box to the available box.
Ingress	Specify the ports to mirror incoming traffic.
Available	Click < to move a severity type from the acting box to the available box. Click > to move a severity type to the acting box from the available box.
Acting	Click < to move a severity type from the acting box to the available box. Click > to move a severity type to the acting box from the available box.
>	Click > to move a severity type to the acting box from the available box.

Table 105 Configuration &gt; Mirror (continued)

LABEL	DESCRIPTION
<	Click < to move a severity type from the acting box to the available box.
Apply	Click <b>Apply</b> to save the changes.
Cancel	Click <b>Cancel</b> to discard the changes.

# CHAPTER 25

## Configuration: Time Range Group

### 25.1 Overview

You can set up one-time and recurring schedules for time-oriented features, such as PoE. The Switch supports one-time and recurring schedules. One-time schedules are effective only once, while recurring schedules usually repeat. Both types of schedules are based on the current date and time in the Switch.

#### 25.1.1 What You Can Do

The **Time Range Group** screen ([Section 25.2.1 on page 164](#)) displays or defines a time range (schedule) rule on the Switch.

### 25.2 Time Range Group





Use this screen to view or edit a time range rule on the Switch.

#### 25.2.1 Time Range Group Settings

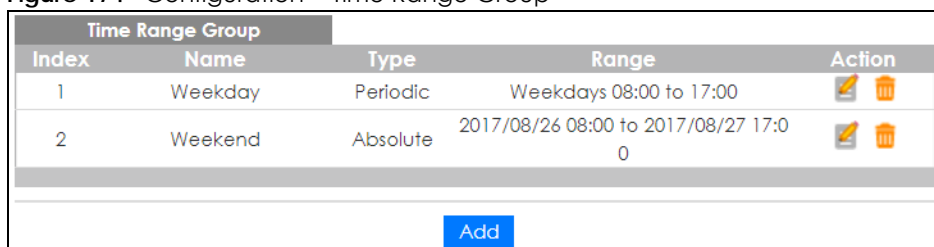
Use this screen to view the time range rules. Click **Configuration > Time Range Group** in the navigation panel to display the screen as shown.

**Figure 174** Configuration > Time Range Group



Time Range Group				
Index	Name	Type	Range	Action
1	Weekday	Periodic	Weekdays 08:00 to 17:00	 
2	Weekend	Absolute	2017/08/26 08:00 to 2017/08/27 17:00 0	 

[Add](#)

The following table describes the labels in this screen.

Table 106 Configuration > Time Range Group

LABEL	DESCRIPTION
Index	This field displays the index number of the rule.
Name	This field displays the descriptive name for this rule. This is for identification purpose only.
Type	This field displays the type of the rule.

Table 106 Configuration &gt; Time Range Group (continued)

LABEL	DESCRIPTION
Range	This field displays the time periods to which this rule applies.
Action	Click <b>Edit</b> to change the rule settings. Click <b>Delete</b> to remove the rule.
Add	Click <b>Add</b> to create a new time range rule.

## 25.2.2 Time Range Add

Use this screen to add a new time range (schedule) rule. Click **Configuration > Time Range Group > Add** in the navigation panel to display the screen as shown.

Figure 175 Configuration &gt; Time Range Group &gt; Add

The following table describes the labels in this screen.

Table 107 Configuration &gt; Time Range Group &gt; Add

LABEL	DESCRIPTION
Name	Enter a descriptive name for this rule for identifying purposes.
Type	Select <b>Absolute</b> to create a one-time schedule. One-time schedules begin on a specific start date and time and end on a specific stop date and time. One-time schedules are useful for long holidays and vacation periods.  Alternatively, select <b>Periodic</b> to create a recurring schedule. Recurring schedules begin at a specific start time and end at a specific stop time on selected days of the week (Sunday, Monday, Tuesday, Wednesday, Thursday, Friday, and Saturday). Recurring schedules are useful for defining the workday and off-work hours.
Absolute	This section is available only when you set <b>Type</b> to <b>Absolute</b> .
Start	Specify the year, month, day, hour and minute when the schedule begins.
End	Specify the year, month, day, hour and minute when the schedule ends.
Periodic	This section is available only when you set <b>Type</b> to <b>Periodic</b> .  Select the first option if you want to define a recurring schedule for a consecutive time period. You then select the day of the week, hour and minute when the schedule begins and ends respectively.  Select the second option if you want to define a recurring schedule for multiple non-consecutive time periods. You need to select each day of the week the recurring schedule is effective. You also need to specify the hour and minute when the schedule begins and ends each day. The schedule begins and ends in the same day.

Table 107 Configuration &gt; Time Range Group &gt; Add (continued)

LABEL	DESCRIPTION
Apply	Click <b>Apply</b> to save your changes to the Switch's run-time memory. The Switch loses these changes if it is turned off or loses power, so use the <b>Save</b> link on the top navigation panel to save your changes to the non-volatile memory when you are done configuring.
Cancel	Click <b>Cancel</b> to reset the fields to your previous configuration.

## 25.2.3 Time Range Edit

Use this screen to modify an existing time range rule. Click **Configuration > Time Range Group > Edit** in the navigation panel to display the screens as shown.

### 25.2.3.1 Edit an Absolute Time Range Rule

Click the **Edit** button in the **Action** field to modify an absolute time range rule.

Figure 176 Configuration &gt; Time Range Group &gt; Edit (Absolute)

Time Range Group	
Name	Weekend
Type	Absolute
Range	Start 2017 ▾ 08 ▾ 26 ▾ 08 ▾ : 00 ▾
	End 2017 ▾ 08 ▾ 27 ▾ 17 ▾ : 00 ▾
<input type="button" value="Apply"/> <input type="button" value="Cancel"/>	

The following table describes the labels in this screen.

Table 108 Configuration &gt; Time Range Group &gt; Edit (Absolute)

LABEL	DESCRIPTION
Name	This field displays the descriptive name for this rule. This is for identification purpose only.
Type	This field displays the type of the rule.
Range	Specify the year, month, day, hour and minute when the schedule begins and ends.
Apply	Click <b>Apply</b> to save your changes to the Switch's run-time memory. The Switch loses these changes if it is turned off or loses power, so use the <b>Save</b> link on the top navigation panel to save your changes to the non-volatile memory when you are done configuring.
Cancel	Click <b>Cancel</b> to reset the fields to your previous configuration.

### 25.2.3.2 Edit a Periodic Time Range Rule

Click the **Edit** button in the **Action** field to modify a periodic time range rule. A screen will appear showing the name, type, and range of this rule. Click the **Edit** button again to modify it, or you can click the **Add** button to create a new range under a periodic time range rule.

**Figure 177** Configuration > Time Range Group > Edit (Periodic)

Time Range Group		
Name	Weekday	
Type	Periodic	
Index	Range	Action
1	Weekdays 08:00 to 17:00	
<a href="#">Add</a>		

The following table describes the labels in this screen.

**Table 109** Configuration > Time Range Group > Edit (Periodic)

LABEL	DESCRIPTION
Time Range Group	
Name	This field displays the descriptive name for this rule. This is for identification purpose only.
Type	This field displays the type of the rule.
Index	This field displays the index number of the rule.
Range	This field displays the time periods to which this rule applies.
Action	Click <b>Edit</b> to change the rule settings. Click <b>Delete</b> to remove the rule.
Add	Click <b>Add</b> to create a new range.

**Figure 178** Configuration > Time Range Group > Edit (Periodic) > Add

Time Range Group	
Name	Weekday
Type	Periodic
Range	<input type="radio"/> Sun 00 : 00 to Sun 00 : 00 <input checked="" type="radio"/> <input type="checkbox"/> Mon <input type="checkbox"/> Tue <input type="checkbox"/> Wed <input type="checkbox"/> Thu <input type="checkbox"/> Fri <input type="checkbox"/> Sat <input type="checkbox"/> Sun <input checked="" type="checkbox"/> Weekday <input type="checkbox"/> Weekend <input type="checkbox"/> Daily
	08 : 00 to 17 : 00
<a href="#">Apply</a> <a href="#">Cancel</a>	

The following table describes the labels in this screen.

**Table 110** Configuration > Time Range Group > Edit (Periodic) > Add

LABEL	DESCRIPTION
Time Range Group	
Name	Enter a descriptive name for this rule for identifying purposes.
Type	This field displays the type of the rule.
Range	Select the first option if you want to define a recurring schedule for a consecutive time period. You then select the day of the week, hour and minute when the schedule begins and ends respectively.  Select the second option if you want to define a recurring schedule for multiple non-consecutive time periods. You need to select each day of the week the recurring schedule is effective. You also need to specify the hour and minute when the schedule begins and ends each day. The schedule begins and ends in the same day.

Table 110 Configuration > Time Range Group > Edit (Periodic) > Add (continued)

LABEL	DESCRIPTION
Apply	Click <b>Apply</b> to save your changes to the Switch's run-time memory. The Switch loses these changes if it is turned off or loses power, so use the <b>Save</b> link on the top navigation panel to save your changes to the non-volatile memory when you are done configuring.
Cancel	Click <b>Cancel</b> to reset the fields to your previous configuration.



# CHAPTER 26

## Configuration: Multicast

### 26.1 Overview

This section provides information for **Multicast** in **Configuration**.

Traditionally, IP packets are transmitted in one of either two ways – Unicast (1 sender to 1 recipient) or Broadcast (1 sender to everybody on the network). Multicast delivers IP packets to just a group of hosts on the network.

### 26.2 IGMP Settings

IGMP (Internet Group Management Protocol) is a network-layer protocol used to establish membership in an IPv4 multicast group – it is not used to carry user data. Refer to RFC 1112, RFC 2236 and RFC 3376 for information on IGMP versions 1, 2 and 3 respectively.

#### 26.2.1 Global Settings

Use this screen to view the **IGMP Global** settings. Click **Configuration > Multicast > IGMP > Global** to open this screen.

**Figure 179** Configuration > Multicast > IGMP > Global

Global	Global	VLAN	Router Port	Profile	Throttling
Snooping State	<input type="radio"/> Enable	<input checked="" type="radio"/> Disable			
Snooping Version	<input checked="" type="radio"/> v2	<input type="radio"/> v3			
Unknown Multicast Action	<input checked="" type="radio"/> Flood	<input type="radio"/> Drop	<input type="radio"/> Router Port		
<input type="button" value="Apply"/> <input type="button" value="Cancel"/>					

The following table describes the labels in this screen.

Table 111 Configuration > Multicast > IGMP > Global

LABEL	DESCRIPTION
Global	
Snooping State	Select <b>Enable</b> to turn on IGMP packet snooping or <b>Disable</b> to turn snooping off.
Snooping Version	Select <b>v2</b> or <b>v3</b> depending on the snooping version you require.

Table 111 Configuration &gt; Multicast &gt; IGMP &gt; Global (continued)

LABEL	DESCRIPTION
Unknown Multicast Action	Select to send the IPv4 unknown multicast frame to the router port. The following options are available: <ul style="list-style-type: none"> <li>• <b>Flood</b> – select to send the frames to all ports.</li> <li>• <b>Drop</b> – select to discard the frames.</li> <li>• <b>Router Port</b> – select to send the frame to router port.</li> </ul>
Apply	Click <b>Apply</b> to save the changes.
Cancel	Click <b>Cancel</b> to discard the changes.

## 26.2.2 VLAN Settings

Use this screen to view the **IGMP VLAN** settings. Click **Configuration > Multicast > IGMP > VLAN** to open this screen.

Figure 180 Configuration &gt; Multicast &gt; IGMP &gt; VLAN

IGMP Vlan										Global	VLAN	Router Port	Profile	Throttling
VLAN ID	State	Router Ports Auto Learn	Query Retry	Interval	Max. Response Interval	Last Member Query Count	Interval	Querier State	Version					
1	Disable	Enable	2	125	10	2	1	Disable	---					

Total Entries: 1

[Edit](#)

The following table describes the labels in this screen.

Table 112 Configuration &gt; Multicast &gt; IGMP &gt; VLAN

LABEL	DESCRIPTION
IGMP Vlan	
VLAN ID	Displays the ID of a static VLAN; the valid range is between 1 and 4094.
State	Display the status of the VLAN as enabled or disabled.
Router Ports Auto Learn	Displays the Switch learn multicast router port member status of any VLANs as enabled or disabled.
Query	
Retry	Displays the number of query retry times.
Interval	Displays the amount of time (in seconds) between general query messages sent by the router connected to the upstream port.
Max. Response Interval (sec)	Displays the amount of time (in seconds) the router connected to the upstream port waits for a response to an IGMP general query message.
Last Member Query	
Count	Displays the number of queries.
Interval	Displays the amount of time (in milliseconds) between the IGMP group-specific queries sent by an upstream port when an IGMP Done message is received.
Querier	
State	Displays the Switch current VLAN querier entry as <b>Enable</b> or <b>Disable</b> .
Version	Displays the Switch current VLAN querier entry version.
Edit	Click <b>Edit</b> to change the properties of the IGMP VLAN entry.

## 26.2.3 Edit IGMP

Use this screen to configure the **IGMP VLAN** settings. Click **Configuration > Multicast > IGMP > VLAN > Edit** to open this screen.

**Figure 181** Configuration > Multicast > IGMP > VLAN > Edit

IGMP Edit		Global	VLAN	Router Port	Profile	Throttling
VLAN List						
IGMP State	<input type="radio"/> Enable <input checked="" type="radio"/> Disable					
Router Ports Auto Learn	<input checked="" type="radio"/> Enable <input type="radio"/> Disable					
Query Retry	2	(1-7)				
Query Interval	125	(30-18000)				
Query Max. Response Interval	10	(5-20)				
Last Member Query Counter	2	(1-7)				
Last Member Query Interval	1	(1-25)				
IGMP Querier State	<input type="radio"/> Enable <input checked="" type="radio"/> Disable					
IGMP Querier Version	<input checked="" type="radio"/> v2 <input type="radio"/> v3					
<input type="button" value="Apply"/> <input type="button" value="Cancel"/>						

The following table describes the labels in this screen.

Table 113 Configuration > Multicast > IGMP > VLAN > Edit

LABEL	DESCRIPTION
IGMP Edit	
VLAN List	Enter the ID of a static VLAN; the valid range is between 1 and 4094.
IGMP State	Select the status of the VLAN to <b>Enable</b> or <b>Disable</b> the function.
Router Ports Auto Learn	Select <b>Enabled</b> to have the Switch learn multicast router membership information of any VLANs automatically.
Query Retry	Enter the number of query retry times. The value can be between 1 and 7.
Query Interval	Enter the amount of time (in seconds) between general query messages sent by the router connected to the upstream port. The value can be between 30 and 18000.
Query Max. Response Interval	Enter the amount of time (in seconds) the router connected to the upstream port waits for a response to an IGMP general query message.
Last Member Query Count	Enter the number of queries.
Last Member Query Interval	Enter the amount of time (in seconds) between the IGMP group-specific queries sent by an upstream port when an IGMP Done message is received.
IGMP Querier State	Select the IGMP querier status to <b>Enable</b> or <b>Disable</b> the function.
IGMP Querier Version	Select the IGMP Querier version to <b>v2</b> or <b>v3</b> .
Apply	Click <b>Apply</b> to save the changes.
Cancel	Click <b>Cancel</b> to discard the changes.

## 26.2.4 Router Port

Use this screen to view the **Router Port** settings. Click **Configuration > Multicast > IGMP > Router Port** to open this screen.

**Figure 182** Configuration > Multicast > IGMP > Router Port

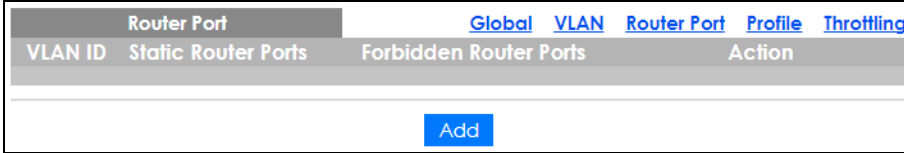

The following table describes the labels in this screen.

Table 114 Configuration > Multicast > IGMP > Router Port

LABEL	DESCRIPTION
Router Port	
VLAN ID	Displays the ID of a static VLAN; the valid range is between 1 and 4094.
Static Router Ports	Displays the ports that are defined as static router ports.
Forbidden Router Ports	Displays the ports that are defined as forbidden router ports.
Action	
Edit	Click <b>Edit</b> to make changes to the entry.
Delete	Click <b>Delete</b> to remove the entry.
Add	Click <b>Add</b> to create a new <b>Router Port</b> entry.

## 26.2.5 Add or Edit Router Port

Use this screen to configure the **Router Port** settings. Click **Configuration > Multicast > IGMP > Router Port > Add** or **Edit** to open this screen.

**Figure 183** Configuration > Multicast > IGMP > Router Port > Add or Edit

The following table describes the labels in this screen.

Table 115 Configuration > Multicast > IGMP > Router Port > Add or Edit

LABEL	DESCRIPTION
IGMP Router Edit	
VLAN List	Enter the static VLAN IDs (valid range for each ID value is between 1 and 4094).
Static Router Ports Selects	Select the ports to be static router ports.
Forbidden Router Ports Selects	Select the ports to be forbidden router ports.
Apply	Click <b>Apply</b> to save the changes.
Cancel	Click <b>Cancel</b> to discard the changes.

## 26.2.6 Profile Settings

Use this screen to view the **IGMP Profile** settings. Click **Configuration > Multicast > IGMP > Profile** to open this screen.

**Figure 184** Configuration > Multicast > IGMP > Profile

The following table describes the labels in this screen.

Table 116 Configuration &gt; Multicast &gt; IGMP &gt; Profile

LABEL	DESCRIPTION
IGMP Profile	
Profile	Displays the <b>Profile</b> index number.
Group From	Displays the profile start group IP address.
Group To	Displays the profile end group IP address.
Match Action	Displays the action of the profile as <b>Permit</b> or <b>Deny</b> .
Action	
Edit	Click <b>Edit</b> to make changes to the entry.
Delete	Click <b>Delete</b> to remove the entry.
Add	Click <b>Add</b> to create a new <b>IGMP Profile</b> entry.

## 26.2.7 Add or Edit Profile

Use this screen to configure the **IGMP Profile** settings. Click **Configuration > Multicast > IGMP > Profile > Add** or **Edit** to open this screen.

Figure 185 Configuration &gt; Multicast &gt; IGMP &gt; Profile &gt; Add or Edit

IGMP Profile		Global	VLAN	Router Port	Profile	Throttling
Profile	1	(1-128)				
Group From						
Group To						
Match Action	<input checked="" type="radio"/> Permit <input type="radio"/> Deny					
<input type="button" value="Apply"/> <input type="button" value="Cancel"/>						

The following table describes the labels in this screen.

Table 117 Configuration &gt; Multicast &gt; IGMP &gt; Profile &gt; Add or Edit

LABEL	DESCRIPTION
IGMP Profile	
Profile	Enter the <b>Profile</b> index number.
Group From	Enter the profile start group IP address.
Group To	Enter the profile end group IP address.
Match Action	Select the action of the profile as to be <b>Permit</b> or <b>Deny</b> .
Apply	Click <b>Apply</b> to save the changes.
Cancel	Click <b>Cancel</b> to discard the changes.

## 26.2.8 Throttling Settings

Use this screen to view the **Throttling** settings. Click **Configuration > Multicast > IGMP > Throttling** to open this screen.

**Figure 186** Configuration > Multicast > IGMP > Throttling

IGMP Port Throttling		Global	VLAN	Router Port	Profile	Throttling
<input type="checkbox"/>	Port	Max. Groups	Exceed Group Number Action	Filter Profile ID		
<input type="checkbox"/>	1	256	Deny	None		
<input type="checkbox"/>	2	256	Deny	None		
<input type="checkbox"/>	3	256	Deny	None		
<input type="checkbox"/>	4	256	Deny	None		
<input type="checkbox"/>	5	256	Deny	None		
<input type="checkbox"/>	6	256	Deny	None		
<input type="checkbox"/>	7	256	Deny	None		
<input type="checkbox"/>	23	256	Deny	None		
<input type="checkbox"/>	24	256	Deny	None		
<input type="checkbox"/>	25	256	Deny	None		
<input type="checkbox"/>	26	256	Deny	None		
<input type="checkbox"/>	LAG1	256	Deny	None		
<input type="checkbox"/>	LAG2	256	Deny	None		
<input type="checkbox"/>	LAG3	256	Deny	None		
<input type="checkbox"/>	LAG4	256	Deny	None		
<input type="checkbox"/>	LAG5	256	Deny	None		
<input type="checkbox"/>	LAG6	256	Deny	None		
<input type="checkbox"/>	LAG7	256	Deny	None		
<input type="checkbox"/>	LAG8	256	Deny	None		

The following table describes the labels in this screen.

**Table 118** Configuration > Multicast > IGMP > Throttling

LABEL	DESCRIPTION
IGMP Port Throttling	
Port	Displays the port index value.
Max. Groups	Displays the maximum number of groups.
Exceed Group Number Action	Displays the action taken by the groups as <b>Permit</b> or <b>Deny</b> .
Filter Profile ID	Displays the throttling filter profile ID.
Edit	Select this check box to configure the properties of a port. Click the <b>Edit</b> button change the properties of the port.
Cancel	Click <b>Cancel</b> to discard the changes.

## 26.2.9 Edit Throttling

Use this screen to configure the **Throttling** settings. Click **Configuration > Multicast > IGMP > Throttling > Edit** to open this screen.

**Figure 187** Configuration > Multicast > IGMP > Throttling > Edit

IGMP Port Throttling		Global	VLAN	Router Port	Profile	Throttling
Port List						
Max. Groups	256	(0-256)				
Exceed Group Number Action	<input checked="" type="radio"/> Deny <input type="radio"/> Replace					
Filter Profile ID	None ▼					
<input type="button" value="Apply"/> <input type="button" value="Cancel"/>						

The following table describes the labels in this screen.

Table 119 Configuration &gt; Multicast &gt; IGMP &gt; Throttling &gt; Edit

LABEL	DESCRIPTION
IGMP Port Throttling	
Port List	Enter the port index values.
Max. Groups	Enter the maximum number of groups. Enter a value between 0 and 256.
Exceed Group Number Action	Select the action taken by the groups to be <b>Deny</b> or <b>Replace</b> .
Filter Profile ID	Select the throttling filter profile ID from the dropdown list.
Apply	Click <b>Apply</b> to save the changes.
Cancel	Click <b>Cancel</b> to discard the changes.



# CHAPTER 27

## Configuration: Spanning Tree

### 27.1 Overview

This section provides information for **Spanning Tree** in **Configuration**.

The Switch supports Spanning Tree Protocol (STP), Rapid Spanning Tree Protocol (RSTP) and Multiple Spanning Tree Protocol (MSTP) as defined in the following standards.

- IEEE 802.1D Spanning Tree Protocol
- IEEE 802.1w Rapid Spanning Tree Protocol
- IEEE 802.1s Multiple Spanning Tree Protocol

The Switch also allows you to set up multiple STP configurations (or trees). Ports can then be assigned to the trees.

### 27.2 Spanning Tree

(R)STP detects and breaks network loops and provides backup links between switches, bridges or routers. It allows a switch to interact with other (R)STP-compliant switches in your network to ensure that only one path exists between any two stations on the network.

#### 27.2.1 Global Settings

Use this screen to view the **Global** settings. Click **Configuration > Spanning Tree > Global** to open this screen.

**Figure 188** Configuration > Spanning Tree > Global

Global	<a href="#">Global</a>	<a href="#">STP Port</a>	<a href="#">CIST</a>	<a href="#">CIST Port</a>	<a href="#">MST</a>	<a href="#">MST Port</a>
State	<input type="radio"/> Enable <input checked="" type="radio"/> Disable					
BPDU Forward	<input checked="" type="radio"/> Flooding <input type="radio"/> Filtering					
PathCost Method	<input type="radio"/> Short <input checked="" type="radio"/> Long					
Version	RSTP ▾					
Configuration Name	4C:9E:FF:72:4A:87					(Max.32 character)
Configuration Revision	0					(0 - 65535)
<input type="button" value="Apply"/> <input type="button" value="Cancel"/>						

The following table describes the labels in this screen.

Table 120 Configuration &gt; Spanning Tree &gt; Global

LABEL	DESCRIPTION
Global	
State	Select to <b>Enable</b> or <b>Disable</b> the Spanning-Tree function.
BPDU Forward	Select the bridge protocol data units forward (BPDU) option to be <b>Flooding</b> or <b>Filtering</b> .
Path Cost Method	Select <b>Short</b> or <b>Long</b> as a <b>Path Cost</b> method.  Path cost is the cost of transmitting a frame on to a LAN through that port. It is recommended that you assign this value according to the speed of the bridge. The slower the media, the higher the cost.
Version	Select the type of spanning tree protocol to use. The following options are available: <ul style="list-style-type: none"> <li>• <b>STP</b></li> <li>• <b>RSTP</b></li> <li>• <b>MSTP</b></li> </ul>
Configuration Name	Enter the name of the configuration in hexadecimal. The maximum number characters is 32.
Configuration Revision	Enter the revision number of configuration. The number can be between 0 and 65535.
Apply	Click <b>Apply</b> to save the changes.
Cancel	Click <b>Cancel</b> to discard the changes.

## 27.2.2 STP Port

Use this screen to view the **STP Port** settings. Click **Configuration > Spanning Tree > STP Port** to open this screen.

Figure 189 Configuration &gt; Spanning Tree &gt; STP Port

STP Port				Global	STP Port	CIST	CIST Port	MST	MST Port
<input type="checkbox"/>	Port	State	External Cost	Edge Port	BPDU Filter	P2P	MAC		
<input type="checkbox"/>	1	Enable	0	Yes	No	Yes			
<input type="checkbox"/>	2	Enable	0	Yes	No	Yes			
<input type="checkbox"/>	3	Enable	0	Yes	No	Yes			
<input type="checkbox"/>	4	Enable	0	Yes	No	Yes			
<input type="checkbox"/>	5	Enable	0	Yes	No	Yes			
<input type="checkbox"/>	6	Enable	0	Yes	No	Yes			
<input type="checkbox"/>	7	Enable	0	Yes	No	Yes			
<input type="checkbox"/>	25	Enable	0	Yes	No	Yes			
<input type="checkbox"/>	26	Enable	0	Yes	No	Yes			
<input type="checkbox"/>	LAG1	Enable	0	Yes	No	Yes			
<input type="checkbox"/>	LAG2	Enable	0	Yes	No	Yes			
<input type="checkbox"/>	LAG3	Enable	0	Yes	No	Yes			
<input type="checkbox"/>	LAG4	Enable	0	Yes	No	Yes			
<input type="checkbox"/>	LAG5	Enable	0	Yes	No	Yes			
<input type="checkbox"/>	LAG6	Enable	0	Yes	No	Yes			
<input type="checkbox"/>	LAG7	Enable	0	Yes	No	Yes			
<input type="checkbox"/>	LAG8	Enable	0	Yes	No	Yes			

The following table describes the labels in this screen.

Table 121 Configuration > Spanning Tree > STP Port

LABEL	DESCRIPTION
STP Port	
Port	Displays the index number of the STP port.
State	Display the status of the STP port as enabled or disabled.
External Cost	Displays the external path cost.
Edge Port	Displays the edge port status as <b>Yes</b> or <b>No</b> .
BPDU Filter	Displays the BPDU filter status as <b>Yes</b> or <b>No</b> .
P2P MAC	Displays the P2P MAC status as <b>Yes</b> or <b>No</b> .
Edit	Select this check box to configure the properties of a port. Click the <b>Edit</b> button change the properties of the port.
Cancel	Click <b>Cancel</b> to discard the changes.

### 27.2.3 STP Port Edit

Use this screen to configure the **STP Port Edit** settings. Click **Configuration > Spanning Tree > STP Port > Edit** to open this screen.

Figure 190 Configuration > Spanning Tree > STP Port > Edit

The following table describes the labels in this screen.

Table 122 Configuration > Spanning Tree > STP Port > Edit

LABEL	DESCRIPTION
STP Port	
Port List	Enter the index number of the STP ports.
External Path Cost (0=Auto)	Enter the external path cost. Enter <b>0</b> for Auto.
State	Select the state of the STP port as enabled or disabled.
Edge Port	Select this check box to configure a port as an edge port when it is directly attached to a computer. An edge port changes its initial STP port state from blocking state to forwarding state immediately without going through listening and learning states right after the port is configured as an edge port or when its link status changes.  Note: An edge port becomes a non-edge port as soon as it receives a Bridge Protocol Data Unit (BPDU).
BPDU Filter	Select <b>Yes</b> to activate BPDU filter or <b>No</b> to deactivate it.

Table 122 Configuration &gt; Spanning Tree &gt; STP Port &gt; Edit (continued)

LABEL	DESCRIPTION
P2P MAC	Select <b>Yes</b> to activate P2P MAC or <b>No</b> to deactivate it.
Migrate	Select <b>Yes</b> to activate Migrate or <b>No</b> to deactivate it.
Apply	Click <b>Apply</b> to save the changes.
Cancel	Click <b>Cancel</b> to discard the changes.

## 27.2.4 CIST Settings

Use this screen to view the **CIST** settings. Click **Configuration > Spanning Tree > CIST** to open this screen.

Figure 191 Configuration &gt; Spanning Tree &gt; CIST

CIST Instance	Global	STP Port	CIST	CIST Port	MSI	MST Port
Priority	32768 ▾					
Max Hops	20	(1-40)				
Forward Delay	15	(4-30)				
Max Age	20	(6-40)				
Tx Hold Count	6	(1-10)				
Hello Time	2	(1-10)				
<input type="button" value="Apply"/> <input type="button" value="Cancel"/>						

The following table describes the labels in this screen.

Table 123 Configuration &gt; Spanning Tree &gt; CIST

LABEL	DESCRIPTION
CIST Instance	
Priority	Configure priority of CIST bridge ID. Priority is part of bridge ID, used for CIST root bridge selection.
Max Hops	Enter a maximum number of hops value. The value can be between 1 and 40.
Forward Delay	This is the maximum time (in seconds) a switch will wait before changing states. This delay is required because every switch must receive information about topology changes before it starts to forward frames. In addition, each port needs time to listen for conflicting information that would make it return to a blocking state; otherwise, temporary data loops might result. The allowed range is 4 to 30 seconds.  As a general rule: $2 * (\text{Forward Delay} - 1) \geq \text{Max Age} \geq 2 * (\text{Hello Time} + 1)$
Max Age	This is the maximum time (in seconds) a switch can wait without receiving a BPDU before attempting to reconfigure. All switch ports (except for designated ports) should receive BPDUs at regular intervals. Any port that ages out STP information (provided in the last BPDU) becomes the designated port for the attached LAN. If it is a root port, a new root port is selected from among the switch ports attached to the network. The allowed range is 6 to 40 seconds.
Tx Hold Count	Enter a transmission hold count value. The value can be between 1 and 10.
Hello Time	This is the time interval in seconds between BPDU (Bridge Protocol Data Units) configuration message generations by the root switch. The allowed range is 1 to 10 seconds.
Apply	Click <b>Apply</b> to save the changes.
Cancel	Click <b>Cancel</b> to discard the changes.

## 27.2.5 CIST Port

Use this screen to view the **CIST Port** settings. Click **Configuration > Spanning Tree > CIST Port** to open this screen.

**Figure 192** Configuration > Spanning Tree > CIST Port

CIST Port		<a href="#">Global</a>	<a href="#">STP Port</a>	<a href="#">CIST</a>	<a href="#">CIST Port</a>	<a href="#">MST</a>	<a href="#">MST Port</a>
<input type="checkbox"/>	Port	Priority	External Path Cost	Internal Path Cost			
<input type="checkbox"/>	1	128	0	0			
<input type="checkbox"/>	2	128	0	0			
<input type="checkbox"/>	3	128	0	0			
<input type="checkbox"/>	4	128	0	0			
<input type="checkbox"/>	5	128	0	0			
<input type="checkbox"/>	6	128	0	0			
<input type="checkbox"/>	7	128	0	0			
<input type="checkbox"/>	24	128	0	0			
<input type="checkbox"/>	25	128	0	0			
<input type="checkbox"/>	26	128	0	0			
<input type="checkbox"/>	LAG1	128	0	0			
<input type="checkbox"/>	LAG2	128	0	0			
<input type="checkbox"/>	LAG3	128	0	0			
<input type="checkbox"/>	LAG4	128	0	0			
<input type="checkbox"/>	LAG5	128	0	0			
<input type="checkbox"/>	LAG6	128	0	0			
<input type="checkbox"/>	LAG7	128	0	0			
<input type="checkbox"/>	LAG8	128	0	0			

[Edit](#) [Cancel](#)

The following table describes the labels in this screen.

**Table 124** Configuration > Spanning Tree > CIST Port

LABEL	DESCRIPTION
CIST Port	
Port	Displays the index number of the STP port.
Priority	Displays the priority for each port here.
External Path Cost	Displays the external path cost.
Internal Path Cost	Displays the internal path cost.
Edit	Select this check box to configure the properties of a port. Click the <b>Edit</b> button change the properties of the port.
Cancel	Click <b>Cancel</b> to discard the changes.

## 27.2.6 CIST Port Edit

Use this screen to configure the **CIST Port Edit** settings. Click **Configuration > Spanning Tree > CIST Port > Edit** to open this screen.

**Figure 193** Configuration > Spanning Tree > CIST Port > Edit

STP CIST Port		<a href="#">Global</a>	<a href="#">STP Port</a>	<a href="#">CIST</a>	<a href="#">CIST Port</a>	<a href="#">MST</a>	<a href="#">MST Port</a>
Port List							
Priority	128						
Internal Path Cost(0 = Auto)	0						
<input type="button" value="Apply"/> <input type="button" value="Cancel"/>							

The following table describes the labels in this screen.

Table 125 Configuration &gt; Spanning Tree &gt; CIST Port &gt; Edit

LABEL	DESCRIPTION
STP CIST Port	
Port List	Enter the index number of the STP ports.
Priority	Configure the priority for each port here.  Priority decides which port should be disabled when more than one port forms a loop in a switch. Ports with a higher priority numeric value are disabled first. The allowed range is between 0 and 255 and the default value is 128.
Internal Path Cost (0=Auto)	Enter the internal path cost. Enter <b>0</b> or Auto.
Apply	Click <b>Apply</b> to save the changes.
Cancel	Click <b>Cancel</b> to discard the changes.

## 27.2.7 MST Settings

Use this screen to view the **MST** settings. Click **Configuration > Spanning Tree > MST** to open this screen.

**Figure 194** Configuration > Spanning Tree > MST

MST Instance		<a href="#">Global</a>	<a href="#">STP Port</a>	<a href="#">CIST</a>	<a href="#">CIST Port</a>	<a href="#">MST</a>	<a href="#">MST Port</a>
MSTI	VLAN List	VLAN Count	Priority	Action			
<input type="button" value="Add"/>							

The following table describes the labels in this screen.

Table 126 Configuration &gt; Spanning Tree &gt; MST

LABEL	DESCRIPTION
MST Instance	
MSTI	This displays the Multiple Spanning Tree Instances (MSTI).
VLAN List	This displays a list of MSTI VLANs.
VLAN Count	This displays the VLAN count.
Priority	This displays the priority for each port here.
Action	
Edit	Click <b>Edit</b> to make changes to the entry.
Delete	Click <b>Delete</b> to remove the entry.
Add	Click <b>Add</b> to create a new <b>MST Instance</b> entry.

## 27.2.8 Add or Edit MST

Use this screen to configure the **MST** settings. Click **Configuration > Spanning Tree > MST > Add** or **Edit** to open this screen.

**Figure 195** Configuration > Spanning Tree > MST > Add or Edit

MST Instance		Global	STP Port	CIST	CIST Port	MST	MST Port
MSTI ID	1						
VLAN List					(1-4094)		
Priority	32768						
<input type="button" value="Apply"/> <input type="button" value="Cancel"/>							

The following table describes the labels in this screen.

Table 127 Configuration > Spanning Tree > MST > Add or Edit

LABEL	DESCRIPTION
MST Instance	
MST ID	Select a Multiple Spanning Tree Instance (MSTI) ID.
VLAN List	Enter a MSTI VLAN ID
Priority	Select a MSTI bridge ID priority value.
Apply	Click <b>Apply</b> to save the changes.
Cancel	Click <b>Cancel</b> to discard the changes.

## 27.2.9 MST Port Settings

Use this screen to view the **MST Port** settings. Click **Configuration > Spanning Tree > MST Port** to open this screen.

**Figure 196** Configuration > Spanning Tree > MST Port

MST Port				
<a href="#">Global</a> <a href="#">STP Port</a> <a href="#">CIST</a> <a href="#">CIST Port</a> <a href="#">MST</a> <a href="#">MST Port</a>				
MST ID		1		
<input type="checkbox"/>	Port	MSTI ID	Priority	Internal Path Cost
<input type="checkbox"/>	1	1	128	0
<input type="checkbox"/>	2	1	128	0
<input type="checkbox"/>	3	1	128	0
<input type="checkbox"/>	4	1	128	0
<input type="checkbox"/>	5	1	128	0
<input type="checkbox"/>	6	1	128	0
<input type="checkbox"/>	7	1	128	0
<input type="checkbox"/>	24	1	128	0
<input type="checkbox"/>	25	1	128	0
<input type="checkbox"/>	26	1	128	0
<input type="checkbox"/>	LAG1	1	128	0
<input type="checkbox"/>	LAG2	1	128	0
<input type="checkbox"/>	LAG3	1	128	0
<input type="checkbox"/>	LAG4	1	128	0
<input type="checkbox"/>	LAG5	1	128	0
<input type="checkbox"/>	LAG6	1	128	0
<input type="checkbox"/>	LAG7	1	128	0
<input type="checkbox"/>	LAG8	1	128	0

The following table describes the labels in this screen.

Table 128 Configuration &gt; Spanning Tree &gt; MST Port

LABEL	DESCRIPTION
MST Port	
MST ID	Select the MST port ID number from the dropdown list.
Port	This displays the index number of the MST port.
MSTI ID	This displays the index value of the MSTI.
Priority	This displays the priority for each port.
Internal Path Cost	This displays the internal path cost.
Edit	Select this check box to configure the properties of a port. Click the <b>Edit</b> button change the properties of the port.
Cancel	Click <b>Cancel</b> to discard the changes.

## 27.2.10 MST Port Edit

Use this screen to configure the **MST Port Edit** settings. Click **Configuration > Spanning Tree > MST Port > Edit** to open this screen.



**Figure 197** Configuration > Spanning Tree > MST Port > Edit

MST Port		<a href="#">Global</a>	<a href="#">STP Port</a>	<a href="#">CIST</a>	<a href="#">CIST Port</a>	<a href="#">MST</a>	<a href="#">MST Port</a>
MSTI ID	1						
Port List							
Priority	128 ▼						
Internal Path Cost(0 = Auto)	0						
<input type="button" value="Apply"/> <input type="button" value="Cancel"/>							

The following table describes the labels in this screen.

**Table 129** Configuration > Spanning Tree > MST Port > Edit

LABEL	DESCRIPTION
STP MST Port	
MST ID	This displays the MST ID number.
Port List	Enter the index number of the MTP ports.
Priority	Configure the priority for each port here.  Priority decides which port should be disabled when more than one port forms a loop in a switch. Ports with a higher priority numeric value are disabled first. The allowed range is between 0 and 255 and the default value is 128.
Internal Path Cost (0=Auto)	Enter the internal path cost. Enter 0 for Auto.
Apply	Click <b>Apply</b> to save the changes.
Cancel	Click <b>Cancel</b> to discard the changes.

# CHAPTER 28

## Configuration: LLDP

### 28.1 Overview

This section provides information for LLDP in **Configuration**.

Use the **Link Layer Discovery Protocol (LLDP)** screens to configure LLDP Switch settings.

### 28.2 LLDP Settings

This page allows the user to inspect and configure the current LLDP port settings.

#### 28.2.1 Global Settings

Use this screen to configure the **Global** settings. Click **Configuration > LLDP > Global** to open this screen.

**Figure 198** Configuration > LLDP > Global

Global		<a href="#">Global</a>	<a href="#">Port</a>	<a href="#">Local Information</a>	<a href="#">MED Network Policy</a>	<a href="#">MED Port</a>
State	<input checked="" type="radio"/> Enable <input type="radio"/> Disable					
Transmission Interval	30	(5-32768 sec)				
Hold Multiplier	4	(2-10)				
Reinitialization Delay	2	(1-10 sec)				
Transmit Delay	2	(1-8192 sec)				
LLDP-MED Fast Start Repeat Count	3	(1-10)				
<input type="button" value="Apply"/> <input type="button" value="Cancel"/>						

The following table describes the labels in this screen.

**Table 130** Configuration > LLDP > Global

LABEL	DESCRIPTION
Global	
State	Select <b>Enable</b> to activate the global LLDP.
Transmission Interval	Enter the transmission interval value. The switch periodically transmits LLDP frames to its neighbors for having the network discovery information up-to-date. The interval between each LLDP frame is determined by the Tx Interval value. Valid values are restricted to 5 – 32768 seconds.

Table 130 Configuration &gt; LLDP &gt; Global (continued)

LABEL	DESCRIPTION
Hold Multiplier	Enter the hold multiplier value.  Each LLDP frame contains information about how long the information in the LLDP frame shall be considered valid. The LLDP information valid period is set to Tx Hold multiplied by Tx Interval seconds. Valid values are restricted to 2 – 10 times.
Reinitialization Delay	Enter the re-initialization delay value.  When a port is disabled, LLDP is disabled or the switch is rebooted, an LLDP shutdown frame is transmitted to the neighboring units, signaling that the LLDP information is not valid anymore. Tx Reinit controls the amount of seconds between the shutdown frame and a new LLDP initialization. Valid values are restricted to 1 – 10 seconds.
Transmit Delay	Enter the transmission delay value.  If some configuration is changed (for example, the IP address) a new LLDP frame is transmitted, but the time between the LLDP frames will always be at least the value of Tx Delay seconds. Tx Delay cannot be larger than 1/4 of the Tx Interval value. Valid values are restricted to 1 – 8192 seconds.
LLDP-MED Fast Start Repeat Count	Enter the LLDP-MED fast start repeat count value.  Because there is a risk of an LLDP frame being lost during transmission between neighbors, it is recommended to repeat the fast start transmission multiple times to increase the possibility of the neighbors receiving the LLDP frame. With Fast start repeat count it is possible to specify the number of times the fast start transmission would be repeated. The recommended value is four times, given that four LLDP frames with a 1 second interval will be transmitted, when an LLDP frame with new information is received.
Apply	Click <b>Apply</b> to save the changes.
Cancel	Click <b>Cancel</b> to discard the changes.

## 28.2.2 Port Settings

Use this screen to view the **Port** settings. Click **Configuration > LLDP > Port** to open this screen.

Figure 199 Configuration > LLDP > Port

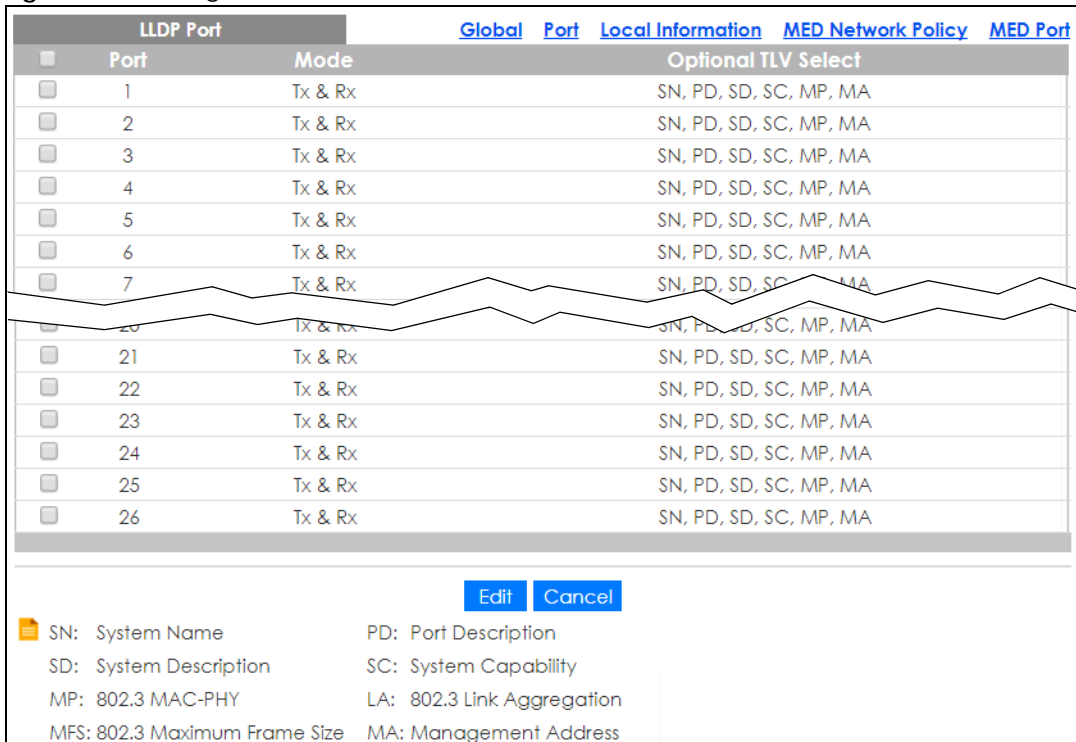

The following table describes the labels in this screen.

Table 131 Configuration > LLDP > Port

LABEL	DESCRIPTION
LLDP VLAN	
Port	Displays the index number of the LLDP port.
Mode	Displays the mode of the LLDP port as <b>Disable</b> , <b>Tx Only</b> , <b>Rx Only</b> , or <b>Tx &amp; Rx</b> .
Optional TLV Select	Displays the TLV as one or more of the following options: <ul style="list-style-type: none"> <li>• SN – System Name</li> <li>• PD – Port Description</li> <li>• SD – System Description</li> <li>• SC – System Capability</li> <li>• MP – 802.3 MAC-PHY</li> <li>• LA – 802.3 Link Aggregation</li> <li>• MFS – 802.3 Maximum Frame Size</li> <li>• MA – Management Address</li> </ul>
Edit	Select this check box to configure the properties of a port. Click the <b>Edit</b> button change the properties of the port.
Cancel	Click <b>Cancel</b> to discard the changes.

### 28.2.3 Port Edit

Use this screen to configure the **Port Edit** settings. Click **Configuration > LLDP > Port > Edit** to open this screen.

**Figure 200** Configuration > LLDP > Port > Edit

The following table describes the labels in this screen.

**Table 132** Configuration > LLDP > Port > Edit

LABEL	DESCRIPTION
LLDP Port	
Port List	Displays the index number of the LLDP ports.
Mode	Select the mode of the LLDP port as <b>Disable</b> , <b>Tx Only</b> , <b>Rx Only</b> , or <b>Tx &amp; Rx</b> .
Optional TLV Select	Select the TLV as one or more of the following options: <ul style="list-style-type: none"> <li>• <b>SN</b> – System Name</li> <li>• <b>PD</b> – Port Description</li> <li>• <b>SD</b> – System Description</li> <li>• <b>SC</b> – System Capability</li> <li>• <b>MP</b> – 802.3 MAC-PHY</li> <li>• <b>LA</b> – 802.3 Link Aggregation</li> <li>• <b>MFS</b> – 802.3 Maximum Frame Size</li> <li>• <b>MA</b> – Management Address</li> </ul>
Apply	Click <b>Apply</b> to save the changes.
Cancel	Click <b>Cancel</b> to discard the changes.

## 28.2.4 Local Information Settings

Use this screen to view the **Local Information** settings. Click **Configuration > LLDP > Local Information** to open this screen.

Figure 201 Configuration &gt; LLDP &gt; Local Information

Local Information		<a href="#">Global</a>	<a href="#">Port</a>	<a href="#">Local Information</a>	<a href="#">MED Network Policy</a>	<a href="#">MED Port</a>
Chassis ID Subtype	MAC Address					
Chassis ID	4C:9E:FF:72:4A:87					
System Name	GS1900					
System Description	GS1900-24HP					
Capabilities Supported	Bridge					
Capabilities Enable	Bridge					
Port ID Subtype	Interface name					
<b>MED Port Location</b>						
<input type="checkbox"/>	Port	Coordinate	Civic Address	ECS ELIN		
<input type="checkbox"/>	1	Latitude:0.0000 North, Longitude:0.0000 East, Altitude:0.0000 , Map Datum:	---	---		
<input type="checkbox"/>	2	Latitude:0.0000 North, Longitude:0.0000 East, Altitude:0.0000 , Map Datum:	---	---		
<input type="checkbox"/>	3	Latitude:0.0000 North, Longitude:0.0000 East, Altitude:0.0000 , Map Datum:	---	---		
<input type="checkbox"/>	4	Latitude:0.0000 North, Longitude:0.0000 East, Altitude:0.0000 , Map Datum:	---	---		
<input type="checkbox"/>	5	Latitude:0.0000 North, Longitude:0.0000 East, Altitude:0.0000 , Map Datum:	---	---		
<input type="checkbox"/>	22	Latitude:0.0000 North, Longitude:0.0000 East, Altitude:0.0000 , Map Datum:	---	---		
<input type="checkbox"/>	23	Latitude:0.0000 North, Longitude:0.0000 East, Altitude:0.0000 , Map Datum:	---	---		
<input type="checkbox"/>	24	Latitude:0.0000 North, Longitude:0.0000 East, Altitude:0.0000 , Map Datum:	---	---		
<input type="checkbox"/>	25	Latitude:0.0000 North, Longitude:0.0000 East, Altitude:0.0000 , Map Datum:	---	---		
<input type="checkbox"/>	26	Latitude:0.0000 North, Longitude:0.0000 East, Altitude:0.0000 , Map Datum:	---	---		
		<a href="#">Edit</a>	<a href="#">Cancel</a>			

The following table describes the labels in this screen.

Table 133 Configuration &gt; LLDP &gt; Local Information

LABEL	DESCRIPTION
Local Information	
Chassis ID Subtype	Displays the chassis ID subtype.
Chassis ID	The <b>Chassis ID</b> is the identification of the neighbor's LLDP frames.
System Name	<b>System Name</b> is the name advertised by the neighbor unit.
System Description	Displays the <b>System Description</b> .

Table 133 Configuration &gt; LLDP &gt; Local Information (continued)

LABEL	DESCRIPTION
Capabilities Supported	<p><b>Capabilities Supported</b> describes the neighbor unit's capabilities. The possible capabilities are:</p> <ol style="list-style-type: none"> <li>1. Other</li> <li>2. Repeater</li> <li>3. Bridge</li> <li>4. WLAN Access Point</li> <li>5. Router</li> <li>6. Telephone</li> <li>7. DOCSIS cable device</li> <li>8. Station only</li> <li>9. Reserved</li> </ol> <p>When a capability is enabled, the capability is followed by (+). If the capability is disabled, the capability is followed by (-).</p>
Capabilities Enable	Displays which capability is enabled.
Port ID Subtype	Displays the <b>Port ID Subtype</b> .
MED Port Location	
Port	Displays the index number of the LLDP ports.
Coordinate	Displays the location coordinate of the LLDP ports.
Civic Address	Displays the location of the civic addresses in hexadecimal.
ECS ELIN	<p>Emergency Call Service (for example, E911 and others), such as defined by TIA or NENA.</p> <p>Emergency Call Service ELIN identifier data format is defined to carry the ELIN identifier as used during emergency call setup to a traditional CAMA or ISDN trunk-based PSAP. This format consists of a numerical digit string, corresponding to the ELIN to be used for emergency calling.</p>
Edit	Select this check box to configure the properties of a port. Click the <b>Edit</b> button change the properties of the port.
Cancel	Click <b>Cancel</b> to discard the changes.

## 28.2.5 Local Information Edit

Use this screen to configure the **Port Edit** settings. Click **Configuration > LLDP > Local Information > Edit** to open this screen.

Figure 202 Configuration > LLDP > Local Information > Edit

MED Port Location		Global	Port	Local Information	MED Network Policy	MED Port
Port List						
Location Coordinate	Latitude	<input type="text" value="0.0000"/>	°	North	▼	
	Longitude	<input type="text" value="0.0000"/>	°	East	▼	
	Altitude	<input type="text" value="0.0000"/>		Meters	▼	
	MapDatum	<input type="text" value="WGS84"/>				
Location Civic Address	Country code	<input type="text"/>				
	State	<input type="text"/>				
	Country	<input type="text"/>				
	City	<input type="text"/>				
	City district	<input type="text"/>				
	Block (Neighbourhood)	<input type="text"/>				
	Street	<input type="text"/>				
	Leading street direction	<input type="text"/>				
	Trailing street suffix	<input type="text"/>				
	Street suffix	<input type="text"/>				
	House no.	<input type="text"/>				
	House no. suffix	<input type="text"/>				
	Landmark	<input type="text"/>				
	Additional location info	<input type="text"/>				
	Name	<input type="text"/>				
	Zip code	<input type="text"/>				
	Building	<input type="text"/>				
	Apartment	<input type="text"/>				
Floor	<input type="text"/>					
Room no.	<input type="text"/>					
Place type	<input type="text"/>					
Postal community name	<input type="text"/>					
P.O. Box	<input type="text"/>					
Location ECS ELIN	<input type="text"/>					
<input type="button" value="Apply"/> <input type="button" value="Cancel"/>						

The following table describes the labels in this screen.

Table 134 Configuration > LLDP > Local Information > Edit

LABEL	DESCRIPTION
MED Port Location	
Port List	Displays the index number of the LLDP ports. The value is made of 16 pairs of hexadecimal characters.
Location Coordinates	
Latitude	<b>Latitude</b> SHOULD be normalized to within 0 – 90 degrees with a maximum of four digits. It is possible to specify the direction to either <b>North</b> of the equator or <b>South</b> of the equator.



Table 134 Configuration &gt; LLDP &gt; Local Information &gt; Edit (continued)

LABEL	DESCRIPTION
Longitude	<p><b>Longitude</b> SHOULD be normalized to within 0 – 180 degrees with a maximum of four digits.</p> <p>It is possible to specify the direction to either <b>East</b> of the prime meridian or <b>West</b> of the prime meridian.</p>
Altitude	<p><b>Altitude</b> SHOULD be normalized to within –32767 to 32767 with a maximum of four digits.</p> <p>It is possible to select between two altitude types (floors or meters).</p> <p><b>Meters:</b> Representing meters of Altitude defined by the vertical datum specified.</p> <p><b>Floors:</b> Representing altitude in a form more relevant in buildings which have different floor-to-floor dimensions. An altitude = 0.0 is meaningful even outside a building, and represents ground level at the given latitude and longitude. Inside a building, 0.0 represents the floor level associated with ground level at the main entrance.</p>
Map Datum	<p>The <b>Map Datum</b> is used for the coordinates given in these options:</p> <p><b>WGS84:</b> (Geographical 3D) – World Geodesic System 1984, CRS Code 4327, Prime Meridian Name: Greenwich.</p> <p><b>NAD83/NAVD88:</b> North American Datum 1983, CRS Code 4269, Prime Meridian Name: Greenwich; The associated vertical datum is the North American Vertical Datum of 1988 (NAVD88). This datum pair is to be used when referencing locations on land, not near tidal water (which would use Datum = NAD83/MLLW).</p> <p><b>NAD83/MLLW:</b> North American Datum 1983, CRS Code 4269, Prime Meridian Name: Greenwich; The associated vertical datum is Mean Lower Low Water (MLLW). This datum pair is to be used when referencing locations on water/sea/ocean.</p>
Location Civic Address	<p>IETF Geopriv Civic Address based Location Configuration Information (Civic Address LCI).</p> <ul style="list-style-type: none"> <li>• <b>Country code:</b> The two-letter ISO 3166 country code in capital ASCII letters – Example: DK, DE or US.</li> <li>• <b>State:</b> National subdivisions (state, canton, region, province, prefecture).</li> <li>• <b>County:</b> County, parish, gun (Japan), district.</li> <li>• <b>City:</b> City, township, shi (Japan) – Example: Copenhagen.</li> <li>• <b>City district:</b> City division, borough, city district, ward, chou (Japan).</li> <li>• <b>Block (Neighborhood):</b> Neighborhood, block.</li> <li>• <b>Street:</b> Street – Example: Poppelvej.</li> <li>• <b>Leading street direction:</b> Leading street direction – Example: N.</li> <li>• <b>Trailing street suffix:</b> Trailing street suffix – Example: SW.</li> <li>• <b>Street suffix:</b> Street suffix - Example: Ave, Platz.</li> <li>• <b>House no.:</b> House number – Example: 21.</li> <li>• <b>House no. suffix:</b> House number suffix – Example: A, 1/2.</li> <li>• <b>Landmark:</b> Landmark or vanity address – Example: Columbia University.</li> <li>• <b>Additional location info:</b> Additional location info – Example: South Wing.</li> <li>• <b>Name:</b> Name (residence and office occupant) – Example: Flemming Jahn.</li> <li>• <b>Zip code:</b> Postal/zip code – Example: 2791.</li> <li>• <b>Building:</b> Building (structure) – Example: Low Library.</li> <li>• <b>Apartment:</b> Unit (Apartment, suite) – Example: Apt 42.</li> <li>• <b>Floor:</b> Floor – Example: 4.</li> <li>• <b>Room no.:</b> Room number – Example: 450F.</li> <li>• <b>Place type:</b> Place type – Example: Office.</li> <li>• <b>Postal community name:</b> Postal community name – Example: Leonia.</li> <li>• <b>P.O. Box:</b> Post office box (P.O. BOX) – Example: 12345.</li> </ul>
Location ECS ELIN	<p>Emergency Call Service (for example, E911 and others), such as defined by TIA or NENA.</p> <p>Emergency Call Service ELIN identifier data format is defined to carry the ELIN identifier as used during emergency call setup to a traditional CAMA or ISDN trunk-based PSAP. This format consists of a numerical digit string, corresponding to the ELIN to be used for emergency calling.</p>

Table 134 Configuration &gt; LLDP &gt; Local Information &gt; Edit (continued)

LABEL	DESCRIPTION
Apply	Click <b>Apply</b> to save the changes.
Cancel	Click <b>Cancel</b> to discard the changes.

## 28.2.6 MED Network Policy

Use this screen to view the **MED Network Policy** settings. Click **Configuration > LLDP > MED Network Policy** to open this screen.

Figure 203 Configuration &gt; LLDP &gt; MED Network Policy

Network Policy Configuration						
No.	Application	VLAN ID	VLAN Tag	L2 Priority	DSCP Value	Action
Add						

The following table describes the labels in this screen.

Table 135 Configuration &gt; LLDP &gt; MED Network Policy

LABEL	DESCRIPTION
Network Policy Configuration	
No.	Displays index of network policy.
Application	Displays the <b>Application type</b> indicating the primary function of the applications.
VLAN ID	Displays the VLAN ID (VID) for the port as defined in IEEE 802.1Q-2003.
VLAN Tag	Displays the <b>VLAN Tag</b> value as <b>Tagged</b> or <b>Untagged</b> .
L2 Priority	Displays the L2 priority layer value.
DSCP Value	Displays the <b>DSCP Value</b> .
Action	
Edit	Click <b>Edit</b> to make changes to the entry.
Delete	Click <b>Delete</b> to remove the entry.
Add	Click <b>Add</b> to create a new <b>Network Policy Configuration</b> entry.

## 28.2.7 MED Network Policy Add or Edit

Use this screen to configure the **Port Edit** settings. Click **Configuration > LLDP > MED Network Policy > Add** or **Edit** to open this screen.

Figure 204 Configuration &gt; LLDP &gt; MED Network Policy &gt; Add or Edit

New Network Policy	
No.	1
Application	Voice
VLAN ID	1 (1-4094)
VLAN Tag	<input type="radio"/> Tagged <input checked="" type="radio"/> Untagged
L2 Priority	0 (0-7)
DSCP Value	0 (0-63)
Apply Cancel	

The following table describes the labels in this screen.

Table 136 Configuration > LLDP > MED Network Policy > Add or Edit

LABEL	DESCRIPTION
New Network Policy	
No.	Select the index of network policy
Application	<p>Select the <b>Application</b> type indicating the primary function of the applications defined for this network policy, advertised by an Endpoint or Network Connectivity Device. The possible application types are shown below.</p> <ol style="list-style-type: none"> <li>1. <b>Voice</b> – for use by dedicated IP Telephony handsets and other similar appliances supporting interactive voice services. These devices are typically deployed on a separate VLAN for ease of deployment and enhanced security by isolation from data applications.</li> <li>2. <b>Voice Signaling</b> – for use in network topologies that require a different policy for the voice signaling than for the voice media.</li> <li>3. <b>Guest Voice</b> – to support a separate limited feature-set voice service for guest users and visitors with their own IP Telephony handsets and other similar appliances supporting interactive voice services.</li> <li>4. <b>Guest Voice Signaling</b> – for use in network topologies that require a different policy for the guest voice signaling than for the guest voice media.</li> <li>5. <b>Softphone Voice</b> – for use by softphone applications on typical data centric devices, such as PCs or laptops.</li> <li>6. <b>Video Conferencing</b> – for use by dedicated Video Conferencing equipment and other similar appliances supporting real-time interactive video or audio services.</li> <li>7. <b>Streaming Video</b> – for use by broadcast or multicast based video content distribution and other similar applications supporting streaming video services that require specific network policy treatment. Video applications relying on TCP with buffering would not be an intended use of this application type.</li> <li>8. <b>Video Signaling</b> – for use in network topologies that require a separate policy for the video signaling than for the video media.</li> </ol>
VLAN ID	Enter the <b>VLAN ID</b> (VID) for the port as defined in IEEE 802.1Q-2003. A value of 1 through 4094 is used to define a valid VLAN ID. A value of 0 (Priority Tagged) is used if the device is using priority tagged frames as defined by IEEE 802.1Q-2003, meaning that only the IEEE 802.1D priority level is significant and the default PVID of the ingress port is used instead.
VLAN Tag	<p><b>TAG</b> is indicative of whether the specified application type is using a tagged or an untagged VLAN. Select <b>Tagged</b> or <b>Untagged</b>.</p> <p><b>Untagged:</b> The device is using an untagged frame format and as such does not include a tag header as defined by IEEE 802.1Q-2003.</p> <p><b>Tagged:</b> The device is using the IEEE 802.1Q tagged frame format.</p>
L2 Priority	<b>Priority</b> is the Layer 2 priority to be used for the specified application type. One of the eight priority levels (0 through 7).
DSCP Value	<b>DSCP</b> is the DSCP value to be used to provide Diffserv node behavior for the specified application type as defined in IETF RFC 2474. Contain one of 64 code point values (0 through 63).
Apply	Click <b>Apply</b> to save the changes.
Cancel	Click <b>Cancel</b> to discard the changes.

## 28.2.8 MED Port

Use this screen to view the **MED Port** settings. Click **Configuration > LLDP > MED Port** to open this screen.

**Figure 205** Configuration > LLDP > MED Port

MED Port		<a href="#">Global</a>	<a href="#">Port</a>	<a href="#">Local Information</a>	<a href="#">MED Network Policy</a>	<a href="#">MED Port</a>
<input type="checkbox"/>	Port	State	Network Policy	Location	PoE	Inventory
<input type="checkbox"/>	1	Disable	No	No	No	No
<input type="checkbox"/>	2	Disable	No	No	No	No
<input type="checkbox"/>	3	Disable	No	No	No	No
<input type="checkbox"/>	4	Disable	No	No	No	No
<input type="checkbox"/>	5	Disable	No	No	No	No
<input type="checkbox"/>	6	Disable	No	No	No	No
<input type="checkbox"/>	21	Disable	No	No	No	No
<input type="checkbox"/>	22	Disable	No	No	No	No
<input type="checkbox"/>	23	Disable	No	No	No	No
<input type="checkbox"/>	24	Disable	No	No	No	No
<input type="checkbox"/>	25	Disable	No	No	No	No
<input type="checkbox"/>	26	Disable	No	No	No	No

The following table describes the labels in this screen.

**Table 137** Configuration > LLDP > MED Port

LABEL	DESCRIPTION
MED Port	
Port	Displays the <b>MED Port</b> value.
State	Displays the state of the MED port as <b>Enable</b> or <b>Disable</b> .
Network Policy	Displays the <b>Network Policy</b> value.
Location	Displays the <b>Location</b> value.
PoE	Displays the <b>PoE</b> value.
Inventory	Displays the <b>Inventory</b> value.
Edit	Select this check box to configure the properties of a port. Click the <b>Edit</b> button change the properties of the port.
Cancel	Click <b>Cancel</b> to discard the changes.

## 28.2.9 MED Port Edit

Use this screen to configure the **MED Port Edit** settings. Click **Configuration > LLDP > MED Port > Edit** to open this screen.

**Figure 206** Configuration > LLDP > MED Port > Edit

The following table describes the labels in this screen.

**Table 138** Configuration > LLDP > MED Port > Edit

LABEL	DESCRIPTION
MED Port	
Port List	Displays the <b>Port List</b> .
State	Select <b>Enable</b> to activate the MED Port feature.
MED Optional TLVs	Select one or more of the MED Optional TLVs: <ul style="list-style-type: none"> <li>• <b>Network Policy</b></li> <li>• <b>Location</b></li> <li>• <b>PoE PSE</b></li> <li>• <b>Inventory</b></li> </ul>
MED Network Policy	Select one or more of the <b>MED Network Policies</b> in <b>Available</b> and move them to <b>Acting</b> to activate.
Apply	Click <b>Apply</b> to save the changes.
Cancel	Click <b>Cancel</b> to discard the changes.

# CHAPTER 29

## Configuration: QoS

### 29.1 Overview

This section provides information for **QoS** (Quality of Service) in **Configuration**.

### 29.2 General Settings

Quality of Service (QoS) refers to both a network's ability to deliver data with minimum delay, and the networking methods used to control the use of bandwidth. Without QoS, all traffic data is equally likely to be dropped when the network is congested. This can cause a reduction in network performance and make the network inadequate for time-critical application such as video-on-demand.

#### 29.2.1 Port Settings

Use this screen to view the **Port** settings. Click **Configuration** > **QoS** > **General** > **Port** to open this screen.

Figure 207 Configuration &gt; QoS &gt; General &gt; Port

QoS Port		<a href="#">Port</a>	<a href="#">Queue</a>	<a href="#">CoS Mapping</a>	<a href="#">DSCP Mapping</a>	<a href="#">IP Precedence Mapping</a>
<input type="checkbox"/>	Port	CoS Value	Remark CoS	Remark DSCP	Remark IP Precedence	
<input type="checkbox"/>	1	0	Disable	Disable	Disable	
<input type="checkbox"/>	2	0	Disable	Disable	Disable	
<input type="checkbox"/>	3	0	Disable	Disable	Disable	
<input type="checkbox"/>	4	0	Disable	Disable	Disable	
<input type="checkbox"/>	5	0	Disable	Disable	Disable	
<input type="checkbox"/>	6	0	Disable	Disable	Disable	
<input type="checkbox"/>	7	0	Disable	Disable	Disable	
<input type="checkbox"/>	8	0	Disable	Disable	Disable	
<input type="checkbox"/>	9	0	Disable	Disable	Disable	
<input type="checkbox"/>	23	0	Disable	Disable	Disable	
<input type="checkbox"/>	24	0	Disable	Disable	Disable	
<input type="checkbox"/>	25	0	Disable	Disable	Disable	
<input type="checkbox"/>	26	0	Disable	Disable	Disable	
<input type="checkbox"/>	LAG1	0	Disable	Disable	Disable	
<input type="checkbox"/>	LAG2	0	Disable	Disable	Disable	
<input type="checkbox"/>	LAG3	0	Disable	Disable	Disable	
<input type="checkbox"/>	LAG4	0	Disable	Disable	Disable	
<input type="checkbox"/>	LAG5	0	Disable	Disable	Disable	
<input type="checkbox"/>	LAG6	0	Disable	Disable	Disable	
<input type="checkbox"/>	LAG7	0	Disable	Disable	Disable	
<input type="checkbox"/>	LAG8	0	Disable	Disable	Disable	

The following table describes the labels in this screen.

Table 139 Configuration &gt; QoS &gt; General &gt; Port

LABEL	DESCRIPTION
QoS Port	
Port	Displays the QoS port list.
CoS Value	Displays the CoS value, range: 0 – 7.
Remark CoS	Displays if this function is disabled or enabled.
Remark DSCP	Displays if this function is disabled or enabled.
Remark IP Precedence	Displays if this function is disabled or enabled.
Edit	Select this check box to configure the properties of a port. Click the <b>Edit</b> button change the properties of the port.
Cancel	Click <b>Cancel</b> to discard the changes.

## 29.2.2 Port Edit

Use this screen to configure the **Port Edit** settings. Click **Configuration > QoS > General > Port > Edit** to open this screen.

**Figure 208** Configuration > QoS > General > Port > Edit

QoS Port		<a href="#">Port</a>	<a href="#">Queue</a>	<a href="#">CoS Mapping</a>	<a href="#">DSCP Mapping</a>	<a href="#">IP Precedence Mapping</a>
Port List						
CoS Value	0					
CoS Remark	<input type="radio"/> Enable <input checked="" type="radio"/> Disable					
DSCP Remark	<input type="radio"/> Enable <input checked="" type="radio"/> Disable					
IP Precedence Remark	<input type="radio"/> Enable <input checked="" type="radio"/> Disable					
<input type="button" value="Apply"/> <input type="button" value="Cancel"/>						

The following table describes the labels in this screen.

**Table 140** Configuration > QoS > General > Port > Edit

LABEL	DESCRIPTION
QoS Port	
Port List	Displays the index number of the QoS ports.
CoS Value	Select the <b>CoS Value</b> from the dropdown list.
CoS Remark	Select Enable to activate <b>CoS Remark</b> .
DSCP Remark	Select Enable to activate <b>DSCP Remark</b> .
IP Precedence Remark	Select Enable to activate <b>IP Precedence Remark</b> .
Apply	Click <b>Apply</b> to save the changes.
Cancel	Click <b>Cancel</b> to discard the changes.

### 29.2.3 Queue Settings

Use this screen to view the **Queue** settings. Click **Configuration > QoS > General > Queue** to open this screen.

**Figure 209** Configuration > QoS > General > Queue

QoS Queue		<a href="#">Port</a>	<a href="#">Queue</a>	<a href="#">CoS Mapping</a>	<a href="#">DSCP Mapping</a>	<a href="#">IP Precedence Mapping</a>
Queue ID	Schedule Algorithm Weight(1 - 127)					
0	<input checked="" type="radio"/> Strict <input type="radio"/> WRR	1				
1	<input checked="" type="radio"/> Strict <input type="radio"/> WRR	2				
2	<input checked="" type="radio"/> Strict <input type="radio"/> WRR	3				
3	<input checked="" type="radio"/> Strict <input type="radio"/> WRR	4				
4	<input checked="" type="radio"/> Strict <input type="radio"/> WRR	5				
5	<input checked="" type="radio"/> Strict <input type="radio"/> WRR	9				
6	<input checked="" type="radio"/> Strict <input type="radio"/> WRR	13				
7	<input checked="" type="radio"/> Strict <input type="radio"/> WRR	15				
<input type="button" value="Apply"/> <input type="button" value="Cancel"/>						



The following table describes the labels in this screen.

Table 141 Configuration > QoS > General > Queue

LABEL	DESCRIPTION
QoS Queue	
Queue ID	Displays the <b>Queue ID</b> value.
Schedule Algorithm	Select the <b>Schedule Algorithm</b> as <b>Strict</b> or <b>WRR</b> .
Weight (1-127)	Enter the weight of the QoS item.
Apply	Click <b>Apply</b> to save the changes.
Cancel	Click <b>Cancel</b> to discard the changes.

## 29.2.4 CoS Mapping

Use this screen to configure the **CoS Mapping** settings. Click **Configuration > QoS > General > CoS Mapping** to open this screen.

Figure 210 Configuration > QoS > General > CoS Mapping

**CoS Mapping** [Port](#) [Queue](#) [CoS Mapping](#) [DSCP Mapping](#) [IP Precedence Mapping](#)

**CoS to Queue Mapping**

Class of Service (CoS)	Queue ID (0 - 7)
0	1
1	0
2	2
3	3
4	4
5	5
6	6
7	7

**Queue to CoS Mapping**

Queue ID	Class of Service (CoS) (0 - 7)
0	1
1	0
2	2
3	3
4	4
5	5
6	6
7	7

[Apply](#) [Cancel](#)

The following table describes the labels in this screen.

Table 142 Configuration > QoS > General > CoS Mapping

LABEL	DESCRIPTION
CoS to Queue Mapping	
Class of Service (CoS)	Displays a listing of the CoS, range: 0 – 7.

Table 142 Configuration > QoS > General > CoS Mapping (continued)

LABEL	DESCRIPTION
Queue ID (0-7)	Click the drop-down menu to map the CoS to a specific Queue ID.
Queue to CoS Mapping	
Queue ID	Displays a listing of the Queue ID, range: 0 – 7.
Class of Service (CoS) (0-7)	Click the drop-down menu to map the Queue ID to a specific CoS.
Apply	Click <b>Apply</b> to save the changes.
Cancel	Click <b>Cancel</b> to discard the changes.

## 29.2.5 DSCP Mapping

Use this screen to configure the **DSCP Mapping** settings. Click **Configuration > QoS > General > DSCP Mapping** to open this screen.

Figure 211 Configuration > QoS > General > DSCP Mapping

DSCP Mapping

[Port](#)
[Queue](#)
[CoS Mapping](#)
[DSCP Mapping](#)
[IP Precedence Mapping](#)

**DSCP to Queue Mapping**

DSCP (0-7)	0	0 ▼	1	0 ▼	2	0 ▼	3	0 ▼
	4	0 ▼	5	0 ▼	6	0 ▼	7	0 ▼
DSCP (8-15)	8	1 ▼	9	1 ▼	10	1 ▼	11	1 ▼
	12	1 ▼	13	1 ▼	14	1 ▼	15	1 ▼
DSCP (16-23)	16	2 ▼	17	2 ▼	18	2 ▼	19	2 ▼
	20	2 ▼	21	2 ▼	22	2 ▼	23	2 ▼
DSCP (24-31)	24	3 ▼	25	3 ▼	26	3 ▼	27	3 ▼
	28	3 ▼	29	3 ▼	30	3 ▼	31	3 ▼
DSCP (32-39)	32	4 ▼	33	4 ▼	34	4 ▼	35	4 ▼
	36	4 ▼	37	4 ▼	38	4 ▼	39	4 ▼
DSCP (40-47)	40	5 ▼	41	5 ▼	42	5 ▼	43	5 ▼
	44	5 ▼	45	5 ▼	46	5 ▼	47	5 ▼
DSCP (48-55)	48	6 ▼	49	6 ▼	50	6 ▼	51	6 ▼
	52	6 ▼	53	6 ▼	54	6 ▼	55	6 ▼
DSCP (56-63)	56	7 ▼	57	7 ▼	58	7 ▼	59	7 ▼
	60	7 ▼	61	7 ▼	62	7 ▼	63	7 ▼

**Queue to DSCP Mapping**

Queue ID	DSCP (0 - 63)
0	0 ▼
1	8 ▼
2	16 ▼
3	24 ▼
4	32 ▼
5	40 ▼
6	48 ▼
7	56 ▼

Apply
Cancel

The following table describes the labels in this screen.

Table 143 Configuration > QoS > General > DSCP Mapping

LABEL	DESCRIPTION
DSCP Mapping	
DSCP to Queue Mapping	
Queue ID	Displays the DSCP <b>Queue ID</b> value.
Queue to DSCP Mapping	
DSCP (0-63)	Select the DSCP mapping value from the dropdown list.
Apply	Click <b>Apply</b> to save the changes.
Cancel	Click <b>Cancel</b> to discard the changes.

## 29.2.6 IP Precedence Mapping

Use this screen to configure the **IP Precedence Mapping** settings. Click **Configuration > QoS > General > IP Precedence Mapping** to open this screen.

Figure 212 Configuration > QoS > General > IP Precedence Mapping

**IP Precedence Mapping** [Port](#) [Queue](#) [CoS Mapping](#) [DSCP Mapping](#) [IP Precedence Mapping](#)

**IP Precedence to Queue Mapping**

IP Precedence	Queue ID (0 - 7)
0	0 ▼
1	1 ▼
2	2 ▼
3	3 ▼
4	4 ▼
5	5 ▼
6	6 ▼
7	7 ▼

**Queue to IP Precedence Mapping**

Queue ID	IP Precedence (0 - 7)
0	0 ▼
1	1 ▼
2	2 ▼
3	3 ▼
4	4 ▼
5	5 ▼
6	6 ▼
7	7 ▼

[Apply](#) [Cancel](#)

The following table describes the labels in this screen.

Table 144 Configuration > QoS > General > IP Precedence Mapping

LABEL	DESCRIPTION
IP Precedence Mapping	
IP Precedence to Queue Mapping	

Table 144 Configuration &gt; QoS &gt; General &gt; IP Precedence Mapping (continued)

LABEL	DESCRIPTION
IP Precedence	Displays a listing of IP Precedence, range: <b>0 – 7</b> .
Queue ID (0–7)	Click the drop-down menu to map an IP Precedence designation to a specific Queue ID (0 – 7).
Queue to IP Precedence Mapping	
Queue ID	Displays a listing of Queue ID, range: <b>0 – 7</b> .
IP Precedence (0–7)	Click the drop-down menu to map a Queue ID to a specific IP precedence.
Apply	Click <b>Apply</b> to save the changes.
Cancel	Click <b>Cancel</b> to discard the changes.

## 29.3 Trust Mode

### 29.3.1 Global Settings

Use this screen to view the **Global** settings. Click **Configuration > QoS > Trust Mode > Global** to open this screen.

Figure 213 Configuration &gt; QoS &gt; Trust Mode &gt; Global

The following table describes the labels in this screen.

Table 145 Configuration &gt; QoS &gt; Trust Mode &gt; Global

LABEL	DESCRIPTION
Global	
Trust Mode	Select the <b>Trust Mode</b> from the dropdown list.
Apply	Click <b>Apply</b> to save the changes.
Cancel	Click <b>Cancel</b> to discard the changes.

### 29.3.2 Port Settings

Use this screen to view the **Port** settings. Click **Configuration > QoS > Trust Mode > Port** to open this screen.

**Figure 214** Configuration > QoS > Trust Mode > Port

QoS Port		Global Port
<input type="checkbox"/>	Port	Mode
<input type="checkbox"/>	1	Untrust
<input type="checkbox"/>	2	Untrust
<input type="checkbox"/>	3	Untrust
<input type="checkbox"/>	4	Untrust
<input type="checkbox"/>	5	Untrust
<input type="checkbox"/>	6	Untrust
<input type="checkbox"/>	7	Untrust
<input type="checkbox"/>	8	Untrust
<input type="checkbox"/>	24	Untrust
<input type="checkbox"/>	25	Untrust
<input type="checkbox"/>	26	Untrust
<input type="checkbox"/>	LAG1	Untrust
<input type="checkbox"/>	LAG2	Untrust
<input type="checkbox"/>	LAG3	Untrust
<input type="checkbox"/>	LAG4	Untrust
<input type="checkbox"/>	LAG5	Untrust
<input type="checkbox"/>	LAG6	Untrust
<input type="checkbox"/>	LAG7	Untrust
<input type="checkbox"/>	LAG8	Untrust

The following table describes the labels in this screen.

**Table 146** Configuration > QoS > Trust Mode > Port

LABEL	DESCRIPTION
QoS Port	
Port	Displays the port index value.
Mode	Displays the Trust status as <b>Trust</b> or <b>Untrust</b> .
Edit	Select this check box to configure the properties of a port. Click the <b>Edit</b> button change the properties of the port.
Cancel	Click <b>Cancel</b> to discard the changes.

### 29.3.3 Trust Mode Edit

Use this screen to configure the **Trust Mode** settings. Click **Configuration > QoS > Trust Mode > Port > Edit** to open this screen.

**Figure 215** Configuration > QoS > Trust Mode > Port > Edit

QoS Port		Global Port
Port List		
Mode	<input type="radio"/> Trust <input checked="" type="radio"/> Untrust	

The following table describes the labels in this screen.

Table 147 Configuration > QoS > Trust Mode > Port > Edit

LABEL	DESCRIPTION
QoS Port	
Port List	Displays the port index values.
Mode	Select the <b>Trust Mode</b> for the QoS port list as <b>Trust</b> or <b>Untrust</b> .
Apply	Click <b>Apply</b> to save the changes.
Cancel	Click <b>Cancel</b> to discard the changes.

# CHAPTER 30

## Configuration: Security

### 30.1 Overview

This section provides information for **Security** in **Configuration**.

### 30.2 Port Security

#### 30.2.1 Global Settings

Use this screen to view the **Global** settings. Click **Configuration > Security > Port Security > Global** to open this screen.

**Figure 216** Configuration > Security > Port Security > Global

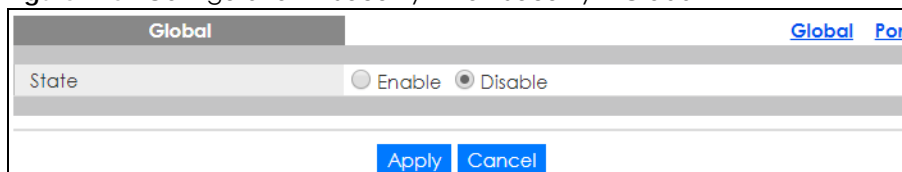

The screenshot shows a web interface for configuring global port security. At the top, there is a header with the word 'Global' and two links, 'Global' and 'Port'. Below the header is a 'State' section with two radio buttons: 'Enable' and 'Disable'. The 'Disable' radio button is selected. At the bottom of the screen, there are two buttons: 'Apply' and 'Cancel'.

The following table describes the labels in this screen.

Table 148 Configuration > Security > Port Security > Global

LABEL	DESCRIPTION
Global	
State	Select the global security setting to be enabled or disabled.
Apply	Click <b>Apply</b> to save the changes.
Cancel	Click <b>Cancel</b> to discard the changes.

#### 30.2.2 Port Settings

Use this screen to view the **Port** settings. Click **Configuration > Security > Port Security > Port** to open this screen.

Figure 217 Configuration &gt; Security &gt; Port Security &gt; Port

Port				<a href="#">Global</a>	<a href="#">Port</a>
<input type="checkbox"/>	Port	State	Max. MAC Entry Number	Action	
<input type="checkbox"/>	1	Disable	Unlimited	---	
<input type="checkbox"/>	2	Disable	Unlimited	---	
<input type="checkbox"/>	3	Disable	Unlimited	---	
<input type="checkbox"/>	4	Disable	Unlimited	---	
<input type="checkbox"/>	5	Disable	Unlimited	---	
<input type="checkbox"/>	6	Disable	Unlimited	---	
<input type="checkbox"/>	7	Disable	Unlimited	---	
<input type="checkbox"/>	23	Disable	Unlimited	---	
<input type="checkbox"/>	24	Disable	Unlimited	---	
<input type="checkbox"/>	25	Disable	Unlimited	---	
<input type="checkbox"/>	26	Disable	Unlimited	---	
<input type="checkbox"/>	LAG1	Disable	Unlimited	---	
<input type="checkbox"/>	LAG2	Disable	Unlimited	---	
<input type="checkbox"/>	LAG3	Disable	Unlimited	---	
<input type="checkbox"/>	LAG4	Disable	Unlimited	---	
<input type="checkbox"/>	LAG5	Disable	Unlimited	---	
<input type="checkbox"/>	LAG6	Disable	Unlimited	---	
<input type="checkbox"/>	LAG7	Disable	Unlimited	---	
<input type="checkbox"/>	LAG8	Disable	Unlimited	---	

The following table describes the labels in this screen.

Table 149 Configuration &gt; Security &gt; Port Security &gt; Port

LABEL	DESCRIPTION
Port	
Port	Displays the port index value.
State	Displays the Trust status as <b>Enable</b> or <b>Disable</b> .
Max. MAC Entry Number	Displays the designated maximum number of allowed MAC entries. The maximum MAC entry number can be learned for individual ports.
Action	Displays the <b>Action</b> as <b>Discard</b> or <b>Shutdown</b> .
Edit	Select this check box to configure the properties of a port. Click the <b>Edit</b> button change the properties of the port.
Cancel	Click <b>Cancel</b> to discard the changes.

### 30.2.3 Port Edit

Use this screen to configure the **Port** settings. Select the ports you want to configure and then click **Edit** in the **Configuration > Security > Port Security > Port** screen to open this screen.



**Figure 218** Configuration > Security > Port Security > Port > Edit

The following table describes the labels in this screen.

**Table 150** Configuration > Security > Port Security > Port > Edit

LABEL	DESCRIPTION
Port Security	
Port List	Displays the port index value.
State	Select <b>Enable</b> or <b>Disable</b> for the Trust status.
Max MAC Entry Number	Enter the maximum MAC entry number (maximum MAC entry number can be learned for individual ports).
Action	Select the <b>Action</b> as <b>Discard</b> or <b>Shutdown</b> .
Apply	Click <b>Apply</b> to save the changes.
Cancel	Click <b>Cancel</b> to discard the changes.

## 30.3 Port Isolation

### 30.3.1 Port Isolation Settings

Use this screen to view the **Port** settings. Click **Configuration > Security > Port Isolation** to open this screen.

**Figure 219** Configuration > Security > Port Isolation

Port	State
<input type="checkbox"/> 1	Disable
<input type="checkbox"/> 2	Disable
<input type="checkbox"/> 3	Disable
<input type="checkbox"/> 4	Disable
<input type="checkbox"/> 5	Disable
<input type="checkbox"/> 6	Disable
<input type="checkbox"/> 7	Disable
<input type="checkbox"/> 8	Disable
<input type="checkbox"/> 9	Disable
<input type="checkbox"/> 10	Disable

The following table describes the labels in this screen.

Table 151 Configuration > Security > Port Isolation

LABEL	DESCRIPTION
Port Isolation	
Port	Displays the port index value.
State	Displays the Trust status as <b>Enable</b> or <b>Disable</b> .
Edit	Select this check box to configure the properties of a port. Click the <b>Edit</b> button change the properties of the port.
Cancel	Click <b>Cancel</b> to discard the changes.

### 30.3.2 Port Isolation Edit

Use this screen to configure the **Port** settings. Click **Configuration > Security > Port Isolation > Edit** to open this screen.

Figure 220 Configuration > Security > Port Isolation > Edit

The following table describes the labels in this screen.

Table 152 Configuration > Security > Port Isolation > Edit

LABEL	DESCRIPTION
Port Isolation	
Port List	Displays the port list index values.
State	Select <b>Enable</b> or <b>Disable</b> for the <b>Protected Port</b> status.
Apply	Click <b>Apply</b> to save the changes.
Cancel	Click <b>Cancel</b> to discard the changes.

## 30.4 802.1X Settings

### 30.4.1 Global Settings

Use this screen to view the **Global** settings. Click **Configuration > Security > 802.1X > Global** to open this screen.

Figure 221 Configuration > Security > 802.1X > Global

The following table describes the labels in this screen.

Table 153 Configuration > Security > 802.1X > Global

LABEL	DESCRIPTION
Global	
State	Select the 802.1X security setting to be enabled or disabled.
Apply	Click <b>Apply</b> to save the changes.
Cancel	Click <b>Cancel</b> to discard the changes.

## 30.4.2 Port Settings

Use this screen to view the **Port** settings. Click **Configuration > Security > 802.1X > Port** to open this screen.

Figure 222 Configuration > Security > 802.1X > Port

Port							Global	Port
<input type="checkbox"/>	Port	State	Reauthentication	Reauthentication Period	Quiet Period	Supplicant Timeout	Maximum Request Retries	
<input type="checkbox"/>	1	No Authentication	Enable	3600	60	30	2	
<input type="checkbox"/>	2	No Authentication	Enable	3600	60	30	2	
<input type="checkbox"/>	3	No Authentication	Enable	3600	60	30	2	
<input type="checkbox"/>	4	No Authentication	Enable	3600	60	30	2	
<input type="checkbox"/>	5	No Authentication	Enable	3600	60	30	2	
<input type="checkbox"/>	6	No Authentication	Enable	3600	60	30	2	
<input type="checkbox"/>	7	No Authentication	Enable	3600	60	30	2	
<input type="checkbox"/>	8	No Authentication	Enable	3600	60	30	2	
<input type="checkbox"/>	9	No Authentication	Enable	3600	60	30	2	
<input type="checkbox"/>	10	No Authentication	Enable	3600	60	30	2	
<input type="checkbox"/>	11	No Authentication	Enable	3600	60	30	2	
<input type="checkbox"/>	12	No Authentication	Enable	3600	60	30	2	
<input type="checkbox"/>	13	No Authentication	Enable	3600	60	30	2	
<input type="checkbox"/>	14	No Authentication	Enable	3600	60	30	2	
<input type="checkbox"/>	15	No Authentication	Enable	3600	60	30	2	
<input type="checkbox"/>	16	No Authentication	Enable	3600	60	30	2	
<input type="checkbox"/>	17	No Authentication	Enable	3600	60	30	2	
<input type="checkbox"/>	18	No Authentication	Enable	3600	60	30	2	
<input type="checkbox"/>	19	No Authentication	Enable	3600	60	30	2	
<input type="checkbox"/>	20	No Authentication	Enable	3600	60	30	2	
<input type="checkbox"/>	21	No Authentication	Enable	3600	60	30	2	
<input type="checkbox"/>	22	No Authentication	Enable	3600	60	30	2	
<input type="checkbox"/>	23	No Authentication	Enable	3600	60	30	2	
<input type="checkbox"/>	24	No Authentication	Enable	3600	60	30	2	
<input type="checkbox"/>	25	No Authentication	Enable	3600	60	30	2	
<input type="checkbox"/>	26	No Authentication	Enable	3600	60	30	2	

[Edit](#) [Cancel](#)

The following table describes the labels in this screen.

Table 154 Configuration > Security > 802.1X > Port

LABEL	DESCRIPTION
Port	
Port	Displays the port index value.
State	Displays the Trust status as enabled or disabled.
Reauthentication	Displays if Reauthentication function is enabled. If enabled, the subscriber has to periodically re-enter his or her user name and password to stay connected to the port.
Reauthentication Period	Displays the Reauthentication period for the function: the period of time when a client has to re-enter his or her user name and password to stay connected to the port.
Quiet Period	Display the time out period to transmit request after receiving a rejection from the server.
Supplicant Time out	Display the time out period to transmit a request when the client does not respond.

Table 154 Configuration &gt; Security &gt; 802.1X &gt; Port (continued)

LABEL	DESCRIPTION
Maximum Request Retries	Enter the maximum number of request retries.
Edit	Select this check box to configure the properties of a port. Click the <b>Edit</b> button change the properties of the port.
Cancel	Click <b>Cancel</b> to discard the changes.

### 30.4.3 Port Edit

Use this screen to configure the **Port** settings. Click **Configuration > Security > 802.1X > Port > Edit** to open this screen.

Figure 223 Configuration &gt; Security &gt; 802.1X &gt; Port &gt; Edit

The following table describes the labels in this screen.

Table 155 Configuration &gt; Security &gt; 802.1X &gt; Port &gt; Edit

LABEL	DESCRIPTION
802.1X Port	
Port List	Displays the port index value.
State	Displays the Trust status as enabled or disabled.
Reauthentication State	Specify if a subscriber has to periodically re-enter his or her user name and password to stay connected to the port. Select <b>Enable</b> to activate feature.
Reauthentication Period	Specify how often a client has to re-enter his or her user name and password to stay connected to the port.
Quiet Period	Display the time out period to transmit request after receiving a rejection from the sever.
Supplicant Period	Display the time out period to transmit a request when the client does not respond.
Maximum Request Retries	Enter the maximum number of request retries.
Apply	Click <b>Apply</b> to save the changes.
Cancel	Click <b>Cancel</b> to discard the changes.

## 30.5 DoS Settings

The Switch protects against Denial of Service (DoS) attacks, such as Scan attack and Ping of Death. The goal of DoS attacks is not to steal information, but to disable a device or network on the Internet.

By default, the DoS feature is disabled. You need to enable it on the Switch and its ports. See [Table 159 on page 215](#) for the types of DoS attacks that the Switch prevents when you turn on this feature. You cannot set the Switch to block a specific type of DoS attacks.

Note: DoS protection does not work on LACP-enabled ports.

### 30.5.1 Global Settings

Use this screen to view the **Global** settings. Click **Configuration > Security > DoS > Global** to open this screen.

**Figure 224** Configuration > Security > DoS > Global

The following table describes the labels in this screen.

Table 156 Configuration > Security > DoS > Global

LABEL	DESCRIPTION
Global	
State	Select the DoS security setting to be enabled or disabled.
Apply	Click <b>Apply</b> to save the changes.
Cancel	Click <b>Cancel</b> to discard the changes.

### 30.5.2 Port Settings

Use this screen to view the **Port** settings. Click **Configuration > Security > DoS > Port** to open this screen.

**Figure 225** Configuration > Security > DoS > Port

Port	State
<input type="checkbox"/> 1	Disable
<input type="checkbox"/> 2	Disable
<input type="checkbox"/> 3	Disable
<input type="checkbox"/> 4	Disable
<input type="checkbox"/> 5	Disable
<input type="checkbox"/> 6	Disable
<input type="checkbox"/> 7	Disable
<input type="checkbox"/> 8	Disable
<input type="checkbox"/> 9	Disable
<input type="checkbox"/> 10	Disable
<input type="checkbox"/> 11	Disable
<input type="checkbox"/> 12	Disable
<input type="checkbox"/> 13	Disable
<input type="checkbox"/> 14	Disable
<input type="checkbox"/> 15	Disable
<input type="checkbox"/> 16	Disable
<input type="checkbox"/> 17	Disable
<input type="checkbox"/> 18	Disable
<input type="checkbox"/> 19	Disable
<input type="checkbox"/> 20	Disable
<input type="checkbox"/> 21	Disable
<input type="checkbox"/> 22	Disable
<input type="checkbox"/> 23	Disable
<input type="checkbox"/> 24	Disable
<input type="checkbox"/> 25	Disable
<input type="checkbox"/> 26	Disable

The following table describes the labels in this screen.

**Table 157** Configuration > Security > DoS > Port

LABEL	DESCRIPTION
Port	
Port	Displays the port index value.
State	Displays the port's DoS feature as <b>Enable</b> or <b>Disable</b> .
Edit	Select this check box to configure the properties of a port. Click the <b>Edit</b> button change the properties of the port.
Cancel	Click <b>Cancel</b> to discard the changes.

### 30.5.3 Port Edit

Use this screen to configure the **Port** settings.

Click **Configuration > Security > DoS > Port > Edit** to open this screen.

**Figure 226** Configuration > Security > DoS > Port > Edit

Port List: \_\_\_\_\_

State:  Enable  Disable

The following table describes the labels in this screen.

Table 158 Configuration &gt; Security &gt; DoS &gt; Port &gt; Edit

LABEL	DESCRIPTION
Port	
Port List	Displays the port index value.
State	Select <b>Enable</b> to activate the port's DoS feature.
Apply	Click <b>Apply</b> to save the changes.
Cancel	Click <b>Cancel</b> to discard the changes.

## 30.5.4 DoS Attack Types

The following table describes the types of DoS attacks that the Switch can prevent when you enable the DoS feature on the Switch and the ports.

Table 159 DoS Attack Types

TYPE	PACKET TYPE	DESCRIPTION
DA_EQUAL_SA	Layer 2	These attacks result from sending a specially crafted packet to a machine where the source MAC address is the same as the destination MAC address. The system attempts to reply to itself, resulting in system lockup.
LAND	Layer 3 IPv4/IPv6	These attacks result from sending a specially crafted packet to a machine where the source host IPv4/IPv6 address is the same as the destination host IPv4/IPv6 address. The system attempts to reply to itself, resulting in system lockup.
UDP_BLAT / TCP_BLAT (Blat Attack)	Layer 3 IPv4/IPv6	These attacks result from sending a specially crafted packet to a machine where the source host UDP/TCP port is the same as the destination host UDP/TCP port. The system attempts to reply to itself, resulting in system lockup.
PoD (Ping of Death)	Layer 3 IPv4/IPv6	Ping of Death uses a "ping" utility to create and send an IP packet that exceeds the maximum 65,536 bytes of data allowed by the IP specification. This may cause systems to crash, hang or reboot.
IPv6_FRAG_LEN_MIN	Layer 3 IPv6	This attack uses IPv6 fragmented packets (excluding the last one) whose payload length is less than 1240 bytes.
ICMP_FRAG_PKT	Layer 3 IPv4/IPv6	This attack uses many small fragmented ICMP packets.
ICMPv4_PING_MAX / ICMPv6_PING_MAX	Layer 3 IPv4/IPv6	This attack uses Ping packets whose length is larger than 512 bytes.
SMURF	Layer 3 IPv4	This attack uses Internet Control Message Protocol (ICMP) echo requests packets (pings) to cause network congestion or outages.
SYNchronization (SYN), ACKnowledgment (ACK) and FINish (FIN) packets are used to initiate, acknowledge and conclude TCP/IP communication sessions. The following scans exploit weaknesses in the TCP/IP specification and try to illicit a response from a host to identify ports for an attack:		
TCP_HDR_LEN_MIN	Layer 3 IPv4	TCP packets with header length less than 20 bytes.
SYN_SPORT_LESS_1024	Layer 3 IPv4/IPv6	TCP SYN packets with source port less than 1024.
NULL_SCAN (Scan Attack)	Layer 3 IPv4/IPv6	TCP sequence number is zero and all control bits are zeros.
XMAS (Scan Attack)	Layer 3 IPv4/IPv6	TCP sequence number is zero and the FIN, URG and PSH bits are set.
SYN_FIN	Layer 3 IPv4/IPv6	SYN and FIN bits are set in the TCP packet.

# CHAPTER 31

## Configuration: AAA

### 31.1 Overview

This section provides information for **AAA** in **Configuration**.

Use the **AAA** screens to configure authentication, authorization and accounting settings on the Switch.

### 31.2 Auth Method

Authentication is the process of determining who a user is and validating access to the Switch. The Switch can authenticate users who try to log in based on user accounts configured on the Switch itself. The Switch can also use an external authentication server to authenticate a large number of users.

#### 31.2.1 Auth Method Settings

Use this screen to view the **Auth Method** settings. Click **Configuration > AAA > Auth Method** to open this screen.

**Figure 227** Configuration > AAA > Auth Method

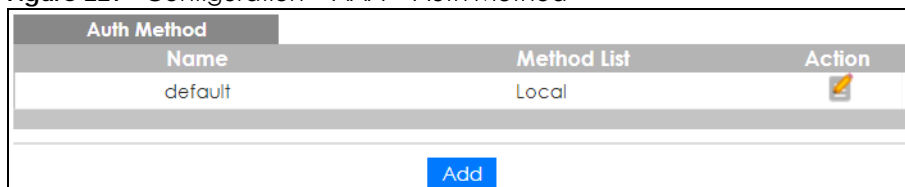

Auth Method		
Name	Method List	Action
default	Local	

[Add](#)

The following table describes the labels in this screen.

**Table 160** Configuration > AAA > Auth Method

LABEL	DESCRIPTION
Auth Method	
Name	Displays the authentication method name. The name can be between 1 and 31 ASCII Alphanumeric Characters.
Method List	Displays the list of authentication methods as being <b>Local</b> or <b>Radius</b> or <b>TACACS+</b> .
Action	Click the <b>Action</b> button to change the configuration settings for a VLAN entry.
Add	Click <b>Add</b> to create a new <b>Auth Method</b> entry.

#### 31.2.2 Auth Method Add or Edit

Use this screen to configure the **Auth Method** settings. Click **Configuration > AAA > Auth Method > Add** or **Edit** to open this screen.



**Figure 228** Configuration > AAA > Auth Method > Add or Edit

The following table describes the labels in this screen.

Table 161 Configuration &gt; AAA &gt; Auth Method &gt; Add or Edit

LABEL	DESCRIPTION
Auth Method	
Name	Enter the authentication method name. The name can be between 1 and 31 ASCII Alphanumeric Characters.
Method 1	Select the first authentication method as being <b>Local</b> , <b>Radius</b> , or <b>TACACS+</b> .
Method 2	Select the second authentication method as being <b>Empty</b> , <b>Local</b> , <b>Radius</b> , or <b>TACACS+</b> .
Method 3	Select the third authentication method as being <b>Empty</b> , <b>Local</b> , <b>Radius</b> , or <b>TACACS+</b> .
Apply	Click <b>Apply</b> to save the changes.
Cancel	Click <b>Cancel</b> to discard the changes.

## 31.3 RADIUS Settings

### 31.3.1 RADIUS

Use this screen to configure the **RADIUS** settings. Click **Configuration > AAA > RADIUS** to open this screen.

**Figure 229** Configuration > AAA > RADIUS

The following table describes the labels in this screen.

Table 162 Configuration &gt; AAA &gt; RADIUS

LABEL	DESCRIPTION
RADIUS Servers	
Server	Displays the server names as an IP address or a domain name.
Auth Port	Displays the authentication port numbers as a value between 0 and 65535.
Key	Displays the authentication key.
Time out	Displays the number of time outs for replies. The value can be between 1 and 30 seconds.
Retries	Displays the number of retries. The value can be between 1 and 30.

Table 162 Configuration &gt; AAA &gt; RADIUS (continued)

LABEL	DESCRIPTION
Priority	Displays the server priority as <b>High</b> or <b>Low</b> .
Usage Type	Displays the server usage type as <b>Login</b> , <b>802.1X</b> , or <b>All</b> .
Action	
Edit	Click to <b>Edit</b> modify the entry.
Delete	Click <b>Delete</b> to delete the entry.
Add	Click <b>Add</b> to create a new <b>Server</b> entry.

### 31.3.2 RADIUS Add or Edit

Use this screen to configure the **RADIUS** settings. Click **Configuration > AAA > RADIUS > Add** or **Edit** to open this screen.

Figure 230 Configuration &gt; AAA &gt; RADIUS &gt; Add or Edit

RADIUS		
Server		( X.X.X.X or Hostname )
Authentication Port	1812	(0-65535)
Key String		(0 -63 ASCII Alphanumeric Characters Used )
Timeout for Reply	3	(1 - 30 sec)
Retries	3	(1 - 10)
Server Priority	<input checked="" type="radio"/> High <input type="radio"/> Low	
Usage	<input type="radio"/> Login <input type="radio"/> 802.1X <input checked="" type="radio"/> All	
<input type="button" value="Apply"/> <input type="button" value="Cancel"/>		

The following table describes the labels in this screen.

Table 163 Configuration &gt; AAA &gt; RADIUS &gt; Add or Edit

LABEL	DESCRIPTION
RADIUS	
Server	Enter the server names as an IP address or a domain name.
Authentication Port	Enter the authentication port numbers as a value between <b>0</b> and <b>65535</b> .
Key String	Enter the authentication key string: 0 – 63 ASCII Alphanumeric Characters.
Timeout for Reply	Enter the number of time outs for replies. The value can be between <b>1</b> and <b>30</b> seconds.
Retries	Enter the number of retries. The value can be between <b>1</b> and <b>30</b> .
Server Priority	Select the server priority as <b>High</b> or <b>Low</b> .
Usage	Select the server usage type as <b>Login</b> , <b>802.1X</b> , or <b>All</b> .
Apply	Click <b>Apply</b> to save the changes.
Cancel	Click <b>Cancel</b> to discard the changes.

## 31.4 TACACS+ Settings

### 31.4.1 TACACS+

Use this screen to configure the **TACACS+** settings. Click **Configuration > AAA > TACACS+** to open this screen.

**Figure 231** Configuration > AAA > TACACS+

TACACS+ Servers					
Server	Port	key	Timeout	Priority	Action
<input type="button" value="Add"/>					

The following table describes the labels in this screen.

Table 164 Configuration > AAA > TACACS+

LABEL	DESCRIPTION
TACACS+ Servers	
Server	Displays the server names as an IP address or a domain name.
Port	Displays the port numbers as a value between <b>0</b> and <b>65535</b> .
Key	Displays the authentication key.
Timeout	Displays the number of time outs for replies. The value can be between <b>1</b> and <b>30</b> seconds.
Priority	Displays the priority as <b>High</b> or <b>Low</b> .
Action	
Edit	Click to <b>Edit</b> modify the entry.
Delete	Click <b>Delete</b> to delete the entry.
Add	Click <b>Add</b> to create a new <b>Server</b> entry.

### 31.4.2 TACACS+ Add or Edit

Use this screen to configure the **TACACS+** settings. Click **Configuration > AAA > TACACS+ > Add** or **Edit** to open this screen.

**Figure 232** Configuration > AAA > TACACS+ > Add or Edit

TACACS+		
Server	<input type="text"/>	(X.X.X.X or Hostname)
Port	49	(0-65535)
Key String	<input type="text"/>	(0 -63 ASCII Alphanumeric Characters Used )
Timeout for Reply	5	(1-30 sec)
Server Priority	<input checked="" type="radio"/> High <input type="radio"/> Low	
<input type="button" value="Apply"/> <input type="button" value="Cancel"/>		

The following table describes the labels in this screen.

Table 165 Configuration > AAA > TACACS+ > Add or Edit

LABEL	DESCRIPTION
TACACS+	
Server	Enter the server names as an IP address or a domain name.
Port	Enter the port numbers as a value between <b>0</b> and <b>65535</b> .
Key String	Enter the authentication key string: 0 – 63 ASCII alphanumeric characters.
Timeout for Reply	Enter the number of time outs for replies. The value can be between <b>1</b> and <b>30</b> seconds.
Server Priority	Select the server priority as <b>High</b> or <b>Low</b> .
Apply	Click <b>Apply</b> to save the changes.
Cancel	Click <b>Cancel</b> to discard the changes.

# CHAPTER 32

## Configuration: Management

### 32.1 Overview

This section provides information for **Management** in **Configuration**.

Use the **Management** screens to configure settings on the Switch. The following sub-menus are accessed from this section: **Syslog**, **SNMP**, **Error Disable**, **HTTP/HTTPS**, **TELNET/SSH**, **Users**, **Remote Access Control**.

### 32.2 Syslog Settings

The syslog feature can store logs in the Switch's memory or send logs to an external syslog server.

#### 32.2.1 Global Settings

Use this screen to view and configure the **Global** settings. Click **Configuration > Management > Syslog > Global** to open this screen.

**Figure 233** Configuration > Management > Syslog > Global

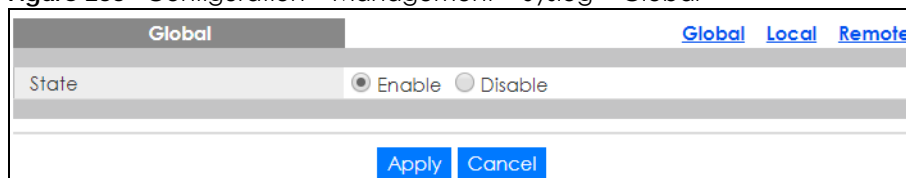

The following table describes the labels in this screen.

Table 166 Configuration > Management > Syslog > Global

LABEL	DESCRIPTION
Global	
State	Select <b>Enable</b> to turn on syslog (system logging) on the Switch. Otherwise, select <b>Disable</b> to turn it off.
Apply	Click <b>Apply</b> to save the changes.
Cancel	Click <b>Cancel</b> to discard the changes.

#### 32.2.2 Local Settings

Use this screen to view the **Local** settings. Click **Configuration > Management > Syslog > Local** to open this screen.

**Figure 234** Configuration > Management > Syslog > Local

Local	Global	Local	Remote
Target	Severity	Action	
Buffered	notice		
<a href="#">Add</a>			

The following table describes the labels in this screen.

**Table 167** Configuration > Management > Syslog > Local

LABEL	DESCRIPTION
Local	
Target	Displays the local storage target for logging messages. It shows whether the logs are stored in the Switch's run-time memory buffer or flash (permanent) memory. If the logs are stored in the Switch's memory buffer, the logs will be erased when the Switch reboots.
Severity	Displays the severity level of messages to be stored in the Switch's memory. The Switch stores the messages of that severity level or higher.
Action	
Edit	Click <b>Edit</b> to make changes to the entry.
Delete	Click <b>Delete</b> to remove the entry.
Add	Click <b>Add</b> to create a new <b>Local</b> entry.

### 32.2.3 Local Add or Edit

Use this screen to configure the **Local** settings. Click **Configuration > Management > Syslog > Local > Add** or **Edit** to open this screen.

**Figure 235** Configuration > Management > Syslog > Local > Add or Edit

Local	Global	Local	Remote
Target	<input checked="" type="radio"/> Buffered <input type="radio"/> Flash		
Severity	emerg ▼		
<a href="#">Apply</a> <a href="#">Cancel</a>			

The following table describes the labels in this screen.

**Table 168** Configuration > Management > Syslog > Local > Add or Edit

LABEL	DESCRIPTION
Local	
Target	Select the local storage target for logging messages. The options are <b>Buffered</b> or <b>Flash</b> .
Severity	Select the severity level of the messages that you want to save in the Switch's memory. The Switch stores the logging messages with the severity level equal to or higher than what you selected. For example, if you select <b>warning</b> , all messages with the <b>warning</b> , <b>error</b> , <b>crit</b> , <b>alert</b> or <b>emerg</b> severity level will be stored.
Apply	Click <b>Apply</b> to save the changes.
Cancel	Click <b>Cancel</b> to discard the changes.

## 32.2.4 Remote Settings

Use this screen to view the **Remote** settings. Click **Configuration > Management > Syslog > Remote** to open this screen.

**Figure 236** Configuration > Management > Syslog > Remote

Remote			
Server	Severity	Facility	Action
<a href="#">Global</a> <a href="#">Local</a> <a href="#">Remote</a>			
<input type="button" value="Add"/>			

The following table describes the labels in this screen.

Table 169 Configuration > Management > Syslog > Remote

LABEL	DESCRIPTION
Remote	
Server	Displays the external syslog server information which includes the server IP address and port number.
Severity	Displays the severity level of messages to be sent to the syslog server. The Switch sends the messages of that severity level or higher.
Facility	Displays the facility designation of the remote entry.
Action	
Edit	Click <b>Edit</b> to make changes to the entry.
Delete	Click <b>Delete</b> to remove the entry.
Add	Click <b>Add</b> to create a new <b>Remote</b> entry.

## 32.2.5 Remote Add or Edit

Use this screen to add an external syslog server. Click **Configuration > Management > Syslog > Remote > Add** or **Edit** to open this screen.

**Figure 237** Configuration > Management > Syslog > Remote > Add or Edit

Remote	
Server	<input type="text" value=""/> ( X.X.X.X or Hostname)
Server Port	<input type="text" value="514"/>
Severity	<input type="text" value="emerg"/> ▼
Facility	<input type="text" value="local0"/> ▼
<input type="button" value="Apply"/> <input type="button" value="Cancel"/>	

The following table describes the labels in this screen.

Table 170 Configuration > Management > Syslog > Remote > Add or Edit

LABEL	DESCRIPTION
Remote	
Server	Enter the IP address or domain name of the syslog server.
Server Port	Enter port number of the syslog server.

Table 170 Configuration &gt; Management &gt; Syslog &gt; Remote &gt; Add or Edit

LABEL	DESCRIPTION
Severity	Select the severity level of the messages that you want the Switch to send to this syslog server. The Switch sends the logging messages with the severity level equal to or higher than what you selected. For example, if you select <b>warning</b> , all messages with the <b>warning</b> , <b>error</b> , <b>crit</b> , <b>alert</b> or <b>emerg</b> severity level will be sent.
Facility	Select the log facility from the dropdown list. The log facility allows you to send logs to different files in the syslog server. Refer to the documentation of your syslog program for more details.
Apply	Click <b>Apply</b> to save the changes.
Cancel	Click <b>Cancel</b> to discard the changes.

## 32.3 SNMP Settings

Simple Network Management Protocol (SNMP) is an application layer protocol used to manage and monitor TCP/IP-based devices. SNMP is used to exchange management information between the network management system (NMS) and a network element (NE). A manager station can manage and monitor the Switch through the network through SNMP version 1 (SNMPv1), SNMP version 2c or SNMP version 3.

### 32.3.1 Global Settings

Use this screen to view and configure the **Global** settings. Click **Configuration > Management > SNMP > Global** to open this screen.

Figure 238 Configuration &gt; Management &gt; SNMP &gt; Global

The following table describes the labels in this screen.

Table 171 Configuration &gt; Management &gt; SNMP &gt; Global

LABEL	DESCRIPTION
Global	
State	Select the global SNMP setting to be enabled or disabled.
Apply	Click <b>Apply</b> to save the changes.
Cancel	Click <b>Cancel</b> to discard the changes.

### 32.3.2 Community Settings

Use this screen to view the **Community** settings. Click **Configuration > Management > SNMP > Community** to open this screen.



**Figure 239** Configuration > Management > SNMP > Community

Community		
Community Name	Access Right	Action
public	Read-Write	

[Add](#)

The following table describes the labels in this screen.

Table 172 Configuration &gt; Management &gt; SNMP &gt; Community

LABEL	DESCRIPTION
Community	
Community Name	Displays a string identifying the community name that this entry should belong to. The allowed string length is 1 to 20, and the allowed content is ASCII characters from <b>33</b> to <b>126</b> .
Access Right	Displays the access mode for this entry. The possible values are <b>Read-Only</b> and <b>Read-Write</b> .
Action	
Edit	Click <b>Edit</b> to make changes to the entry.
Delete	Click <b>Delete</b> to remove the entry.
Add	Click <b>Add</b> to create a new <b>SNMP Community</b> entry.

### 32.3.3 Community Add or Edit

Use this screen to configure the **Community** settings. Click **Configuration > Management > SNMP > Community > Add** or **Edit** to open this screen.

**Figure 240** Configuration > Management > SNMP > Community > Add or Edit

Community	
Community Name	<input type="text"/>
Access Right	<input checked="" type="radio"/> Read-Only <input type="radio"/> Read-Write

[Apply](#) [Cancel](#)

The following table describes the labels in this screen.

Table 173 Configuration &gt; Management &gt; SNMP &gt; Community &gt; Add or Edit

LABEL	DESCRIPTION
Community	
Community Name	Enter a string identifying the community name that this entry should belong to. The allowed string length is 1 to 20, and the allowed content is ASCII characters from <b>33</b> to <b>126</b> .
Access Right	Select the access mode for this entry. The possible values are <b>Read-Only</b> and <b>Read-Write</b> .
Apply	Click <b>Apply</b> to save the changes.
Cancel	Click <b>Cancel</b> to discard the changes.

### 32.3.4 Group Settings

Use this screen to view the **Group** settings. Click **Configuration > Management > SNMP > Group** to open this screen.

**Figure 241** Configuration > Management > SNMP > Group

SNMPv3 Group		Global	Community	Group	User	Trap	Trap Destination
Group Name	Security Model	Security Level	Access Right	Action			
TW	v3	noauth	Read-Only				
TW-1	v3	auth	Read-Only				
TW-2	v3	noauth	Read-Write				
TW-3	v3	priv	Read-Only				
TW-4	v3	auth	Read-Write				
TW-5	v3	priv	Read-Write				

[Add](#)

The following table describes the labels in this screen.

**Table 174** Configuration > Management > SNMP > Group

LABEL	DESCRIPTION
SNMPv3 Group	
Group Name	Displays a string identifying the group name that this entry should belong to. The allowed string length is 1 to 30, and the allowed content is ASCII characters from <b>33</b> to <b>126</b> .
Security Model	Displays the security model that this entry belongs to. <ul style="list-style-type: none"> <li><b>v3</b>: Reserved for SNMPv3.</li> </ul>
Security Level	Displays the security level that this entry belongs to. Possible security levels are: <ul style="list-style-type: none"> <li><b>noauth</b>: No authentication and no privacy.</li> <li><b>auth</b>: Authentication and no privacy.</li> <li><b>Priv</b>: Authentication and privacy.</li> </ul>
Access Right	Displays the access mode for this entry. The possible values are <b>Read Only</b> and <b>Read-Write</b> .
Action	
Edit	Click <b>Edit</b> to make changes to the entry.
Delete	Click <b>Delete</b> to remove the entry.
Add	Click <b>Add</b> to create a new <b>SNMPv3 Group</b> entry.

### 32.3.5 Group Add or Edit

Use this screen to configure the **Group** settings. Click **Configuration > Management > SNMP > Group > Add** or **Edit** to open this screen.

**Figure 242** Configuration > Management > SNMP > Group > Add or Edit

SNMPv3 Group		Global	Community	Group	User	Trap	Trap Destination
Group Name	<input type="text"/>						
Security Level	noauth ▾						
Access Mode	<input checked="" type="radio"/> Read-Only <input type="radio"/> Read-Write						

[Apply](#) [Cancel](#)

The following table describes the labels in this screen.

Table 175 Configuration > Management > SNMP > Group > Add or Edit

LABEL	DESCRIPTION
SNMPv3 Group	
Group Name	Enter a string identifying the group name that this entry should belong to. The allowed string length is 1 to 30, and the allowed content is ASCII characters from 33 to 126.
Security Level	Select the security level that this entry belongs to. Possible security levels are: <ul style="list-style-type: none"> <li>• <b>noauth</b>: No authentication and no privacy.</li> <li>• <b>auth</b>: Authentication and no privacy.</li> <li>• <b>priv</b>: Authentication and privacy.</li> </ul>
Access Mode	Select the access mode for this entry. The possible values are <b>Read-Only</b> and <b>Read-Write</b> .
Apply	Click <b>Apply</b> to save the changes.
Cancel	Click <b>Cancel</b> to discard the changes.

### 32.3.6 User Settings

Use this screen to view the **User** settings. Click **Configuration > Management > SNMP > User** to open this screen.

Figure 243 Configuration > Management > SNMP > User

SNMP User							
		Global	Community	Group	User	Trap	Trap Destination
User Name	Group	Privilege Mode	Authentication Protocol	Encryption Protocol	Access Right	Action	
							<a href="#">Add</a>

The following table describes the labels in this screen.

Table 176 Configuration > Management > SNMP > User

LABEL	DESCRIPTION
SNMP User	
User Name	Displays a string identifying the user name that this entry belongs to. The allowed string length is 1 to 30, and the allowed content is ASCII characters from 33 to 126.
Group	Displays a string identifying the group name that this entry belongs to. The allowed string length is 1 to 30, and the allowed content is ASCII characters from 33 to 126.
Privilege Mode	Displays the privilege mode that this entry belongs to.
Authentication Protocol	Displays the authentication protocol that this entry belongs to. Possible authentication protocols are: <ul style="list-style-type: none"> <li>• <b>None</b>: No authentication protocol.</li> <li>• <b>MD5</b>: An optional flag to indicate that this user uses MD5 authentication protocol.</li> <li>• <b>SHA</b>: An optional flag to indicate that this user uses SHA authentication protocol.</li> </ul> <p>The value of the security level cannot be modified if the entry already exists. That means you must first ensure that the value is set correctly.</p>
Encryption Protocol	Displays the encryption protocol that this entry belongs to.
Access Right	Displays the access mode for this entry. The possible values are <b>Read-Only</b> and <b>Read-Write</b> .
Action	
Edit	Click <b>Edit</b> to make changes to the entry.

Table 176 Configuration &gt; Management &gt; SNMP &gt; User (continued)

LABEL	DESCRIPTION
Delete	Click <b>Delete</b> to remove the entry.
Add	Click <b>Add</b> to create a new SNMP user.

### 32.3.7 User Add or Edit

Use this screen to configure the **User** settings. Click **Configuration > Management > SNMP > User > Add** or **Edit** to open this screen.

Figure 244 Configuration &gt; Management &gt; SNMP &gt; User &gt; Add or Edit

The following table describes the labels in this screen.

Table 177 Configuration &gt; Management &gt; SNMP &gt; User &gt; Add or Edit

LABEL	DESCRIPTION
SNMP User	
User Name	Enter a string identifying the user name that this entry belongs to. The allowed string length is 1 to 30, and the allowed content is ASCII characters from <b>33</b> to <b>126</b> .
Group Name	Enter a string identifying the group name that this entry belongs to. The allowed string length is 1 to 30, and the allowed content is ASCII characters from <b>33</b> to <b>126</b> .
Auth Protocol	Select the authentication protocol that this entry belongs to. Possible authentication protocols are: <ul style="list-style-type: none"> <li><b>MD5</b>: An optional flag to indicate that this user uses MD5 authentication protocol.</li> <li><b>SHA</b>: An optional flag to indicate that this user uses SHA authentication protocol.</li> </ul> The value of the security level cannot be modified if the entry already exists. That means you must first ensure that the value is set correctly.
Auth Password	Enter a string identifying the authentication password phrase. For MD5 authentication protocol, the allowed string length is 8 to 32. For SHA authentication protocol, the allowed string length is 8 to 32. The allowed content is ASCII characters from <b>33</b> to <b>126</b> .
Priv Password	Enter a string identifying the privacy password phrase. The allowed string length is 8 to 64 and the allowed content is ASCII characters from <b>33</b> to <b>126</b> .
Apply	Click <b>Apply</b> to save the changes.
Cancel	Click <b>Cancel</b> to discard the changes.

### 32.3.8 Trap Settings

Use this screen to configure the **Trap** settings. Click **Configuration > Management > SNMP > Trap** to open this screen.



Table 179 Configuration &gt; Management &gt; SNMP &gt; Trap Destination (continued)

LABEL	DESCRIPTION
Version	Indicates the SNMP trap supported version. Possible versions are: <ul style="list-style-type: none"> <li><b>v1</b>: Set SNMP trap supported version 1.</li> <li><b>v2c</b>: Set SNMP trap supported version 2c.</li> <li><b>v3</b>: Set SNMP trap supported version 3.</li> </ul>
Community/User Name	Displays the community or user name that this entry belongs to.
UDP Port	Displays the trap use destination for the UDP port.
Action	
Edit	Click <b>Edit</b> to make changes to the entry.
Delete	Click <b>Delete</b> to remove the entry.
Add	Click <b>Add</b> to create a new <b>SNMP Trap Host</b> entry.

### 32.3.10 Trap Destination Add or Edit

Use this screen to configure the **Trap Destination** settings. Click **Configuration > Management > SNMP > Trap Destination > Add** or **Edit** to open this screen.

Figure 247 Configuration &gt; Management &gt; SNMP &gt; Trap Destination &gt; Add or Edit

The following table describes the labels in this screen.

Table 180 Configuration &gt; Management &gt; SNMP &gt; Trap Destination &gt; Add or Edit

LABEL	DESCRIPTION
Trap Destination	
Server	Enter the IP address of the server or a string identifying the server address that this entry belongs to.
Version	Select the SNMP trap supported version. Possible versions are: <ul style="list-style-type: none"> <li><b>v1</b>: Set SNMP trap supported version 1.</li> <li><b>v2c</b>: Set SNMP trap supported version 2c.</li> <li><b>v3</b>: Set SNMP trap supported version 3.</li> </ul>
Community Name	Displays the community name that this entry belongs to.
User Name	Displays the user name that this entry belongs to.
UDP Port	Enter a UDP port for this entry.
Apply	Click <b>Apply</b> to save the changes.
Cancel	Click <b>Cancel</b> to discard the changes.

## 32.4 Error Disable

### 32.4.1 Error Disable Settings

Use this screen to configure the **Error Disabled** settings. Click **Configuration > Management > Error Disable** to open this screen.

**Figure 248** Configuration > Management > Error Disable

Error Disable		
Recovery Interval	300	(0-86400 sec)
Broadcast Flood	<input type="radio"/> Enable	<input checked="" type="radio"/> Disable
Unknown Multicast Flood	<input type="radio"/> Enable	<input checked="" type="radio"/> Disable
Unicast Flood	<input type="radio"/> Enable	<input checked="" type="radio"/> Disable
Port Security	<input type="radio"/> Enable	<input checked="" type="radio"/> Disable
<input type="button" value="Apply"/> <input type="button" value="Cancel"/>		

The following table describes the labels in this screen.

Table 181 Configuration > Management > Error Disable

LABEL	DESCRIPTION
Error Disable	
Recovery Interval	Enter the recovery interval value.
Broadcast Flood	Select an option to <b>Enable</b> or <b>Disable</b> the Broadcast Flood.
Unknown Multicast Flood	Select an option to <b>Enable</b> or <b>Disable</b> the Unknown Multicast Flood.
Unicast Flood	Select an option to <b>Enable</b> or <b>Disable</b> the Unicast Flood.
Port Security	Select an option to <b>Enable</b> or <b>Disable</b> the Port Security.
Apply	Click <b>Apply</b> to save the changes.
Cancel	Click <b>Cancel</b> to discard the changes.

## 32.5 HTTP/HTTPS

### 32.5.1 HTTP Settings

Use this screen to configure the **HTTP** settings. Click **Configuration > Management > HTTP/HTTPS > HTTP** to open this screen.

**Figure 249** Configuration > Management > HTTP/HTTPS > HTTP

The following table describes the labels in this screen.

**Table 182** Configuration > Management > HTTP/HTTPS > HTTP

LABEL	DESCRIPTION
HTTP	
State	Select the HTTP mode operation. Possible modes are: <ul style="list-style-type: none"> <li>• <b>Enabled:</b> Enable HTTP mode operation.</li> <li>• <b>Disabled:</b> Disable HTTP mode operation.</li> </ul>
Authentication Method	Select the authentication method from the dropdown list.
Session Timeout	Enter the session timeout value. The timeout can be between 0 and 86400 minutes.
Apply	Click <b>Apply</b> to save the changes.
Cancel	Click <b>Cancel</b> to discard the changes.

## 32.5.2 HTTPS Settings

Use this screen to configure the **HTTPS** settings. Click **Configuration > Management > HTTP/HTTPS > HTTPS** to open this screen.

**Figure 250** Configuration > Management > HTTP/HTTPS > HTTPS

The following table describes the labels in this screen.

**Table 183** Configuration > Management > HTTP/HTTPS > HTTPS

LABEL	DESCRIPTION
HTTPS	
State	Select the HTTPS mode operation. Possible mode is: <ul style="list-style-type: none"> <li>• <b>Enable:</b> Enable HTTPS mode operation.</li> </ul>
Authentication Method	Select the authentication method from the dropdown list.



Table 183 Configuration &gt; Management &gt; HTTP/HTTPS &gt; HTTPS (continued)

LABEL	DESCRIPTION
Session Timeout	Enter the session timeout value. The timeout can be between 0 and 86400 minutes.
Re-Generate Certificate	Click this to renew the HTTPS certificate that is verified by a third-party to create secure HTTPS connections between your computer and the Switch. This allows you to securely access the Switch using the Web Configurator.  Note: Re-generating the certificate will cause a network connection reset.
Apply	Click <b>Apply</b> to save the changes.
Cancel	Click <b>Cancel</b> to discard the changes.

## 32.6 TELNET/SSH

### 32.6.1 TELNET Settings

Use this screen to configure the **TELNET** settings. Click **Configuration > Management > TELNET/SSH > TELNET** to open this screen.

Figure 251 Configuration &gt; Management &gt; TELNET/SSH &gt; TELNET

The following table describes the labels in this screen.

Table 184 Configuration &gt; Management &gt; TELNET/SSH &gt; TELNET

LABEL	DESCRIPTION
TELNET	
State	You can allow the Switch for remote Telnet access. The administrator uses Telnet from a computer on a remote network to access the Switch. <ul style="list-style-type: none"> <li><b>Enable:</b> allow remote Telnet access.</li> <li><b>Disable:</b> do not allow remote Telnet access.</li> </ul>
Apply	Click <b>Apply</b> to save the changes.
Cancel	Click <b>Cancel</b> to discard the changes.

### 32.6.2 SSH Settings

Use this screen to configure the **SSH** settings. Click **Configuration > Management > TELNET/SSH > SSH** to open this screen.

Figure 252 Configuration &gt; Management &gt; TELNET/SSH &gt; SSH

The following table describes the labels in this screen.

Table 185 Configuration &gt; Management &gt; TELNET/SSH &gt; SSH

LABEL	DESCRIPTION
SSH	
State	You can allow a remote computer to access the Switch using SSH (Secure SHell protocol). <ul style="list-style-type: none"> <li>• <b>Enable:</b> allow SSH connection.</li> <li>• <b>Disable:</b> do not allow SSH connection.</li> </ul>
Apply	Click <b>Apply</b> to save the changes.
Cancel	Click <b>Cancel</b> to discard the changes.

## 32.7 Users Settings

### 32.7.1 Users

Use this screen to configure the **Users** settings. Click **Configuration > Management > Users** to open this screen.

Figure 253 Configuration &gt; Management &gt; Users

User	Password	Privilege Level	Action
admin	*****	Admin	

[Add](#)

The following table describes the labels in this screen.

Table 186 Configuration &gt; Management &gt; Users

LABEL	DESCRIPTION
Users	
User	A string identifying the user name that this entry should belong to. The allowed string length is 1 to 32. The valid user name is a combination of letters, numbers and underscores.
Password	Displays the password of the user. The allowed string length is 1 to 64.
Privilege Level	Displays the privilege level of the user, range: admin and user.
Action	
Edit	Click <b>Edit</b> to make changes to the entry.
Delete	Click <b>Delete</b> to remove the entry.
Add	Click <b>Add</b> to create a new <b>User</b> entry.

### 32.7.2 Users Add or Edit

Use this screen to configure the **Users** settings. Click **Configuration > Management > Users > Add or Edit** to open this screen.

**Figure 254** Configuration > Management > Users > Add or Edit

The following table describes the labels in this screen.

**Table 187** Configuration > Management > Users > Add or Edit

LABEL	DESCRIPTION
Users	
User	Enter a string identifying the user name that this entry should belong to. The allowed string length is 1 to 32. The valid user name is a combination of letters, numbers and underscores.
Encryption	Select how the password is shown in the <b>Configuration &gt; Management &gt; Users</b> screen and in the configuration file saved in <b>Maintenance &gt; Configuration &gt; Backup</b> .  Note: Make sure to select <b>Encrypted</b> to avoid displaying passwords as plain text in the <b>Users</b> screen and configuration file.  <ul style="list-style-type: none"> <li><b>Clear Text</b> – The password is shown in plain text.</li> <li><b>Encrypted</b> – The password is shown as asterisks (*).</li> </ul> Note: Be careful who can access configuration files with no password or clear text passwords.
Password	Enter a password using the keyboard characters ("a – z", "A – Z", "0 – 9", "~!@#\$\$%^&*( )_+`-={} :;<>.\") for the user. The allowed string length is 1 to 64.
Password Confirm	Enter the same password again to confirm.
Privilege Level	Select the privilege level of the user range: <b>Admin</b> and <b>User</b> .
Apply	Click <b>Apply</b> to save the changes.
Cancel	Click <b>Cancel</b> to discard the changes.

## 32.8 Remote Access Control

### 32.8.1 Global Settings

Use this screen to configure the **Global** settings. Click **Configuration > Management > Remote Access Control > Global** to open this screen.

**Figure 255** Configuration > Management > Remote Access Control > Global

The screenshot shows a configuration interface for Remote Access Control. At the top, there's a 'Global' section with a 'State' field containing two radio buttons: 'Enable' and 'Disable'. The 'Disable' radio button is selected. Below this are two buttons: 'Apply' and 'Cancel'. Underneath is a 'Profile' section which is a table with the following columns: 'No.', 'Action', 'Source IP', 'Source IP Mask', 'Port', 'Service', and 'Action'. Below the table is an 'Add' button.

The following table describes the labels in this screen.

Table 188 Configuration &gt; Management &gt; Remote Access Control &gt; Global

LABEL	DESCRIPTION
Global	
State	Select the global remote access setting to be enabled or disabled.
Apply	Click <b>Apply</b> to save the changes.
Cancel	Click <b>Cancel</b> to discard the changes.
Profile	
No.	Displays the priority level of the entry. The value can be between <b>1</b> and <b>16</b> .
Action	Displays the action value. The values are <b>Permit</b> or <b>Deny</b> .
Source IP	Display the source IP value.
Source IP Mask	Displays the source IP mask.
Port	Display the port value.
Service	Display the service used for remote access. The values are <b>ALL</b> , <b>HTTP</b> , <b>HTTPS</b> , or <b>SNMP</b> .
Action	
Edit	Click <b>Edit</b> to make changes to the entry.
Delete	Click <b>Delete</b> to remove the entry.
Add	Click <b>Add</b> to create a new profile entry.

### 32.8.2 Profile Add or Edit

Use this screen to configure the **Profile** settings. Click **Configuration > Management > Remote Access Control > Global > Add** or **Edit** to open this screen.

**Figure 256** Configuration > Management > Remote Access Control > Global > Add or Edit

The following table describes the labels in this screen.

Table 189 Configuration &gt; Management &gt; Remote Access Control &gt; Global &gt; Add or Edit

LABEL	DESCRIPTION
Management Access List	
No.	Enter the priority level of the entry. The value can be between <b>1</b> and <b>16</b> .
Action	Select the action value. The values are <b>Permit</b> or <b>Deny</b> .
Port	Select a value in <b>Available</b> and click the <b>Add (&gt;)</b> icon to transfer to the Acting column. Select a value in <b>Acting</b> and click the <b>Remove (&lt;)</b> icon to transfer to the Available column.
Source	Select the source IP value. The options are <b>ALL</b> or <b>IPv4/Mask</b> .
IPv4/Mask	Select and enter the IPv4 address and subnet mask of a computer which will be allowed or denied to access the Switch.
Service	Select the service to use for remote access. The values are <b>ALL</b> , <b>HTTP</b> , <b>HTTPS</b> , or <b>SNMP</b> .
Apply	Click <b>Apply</b> to save the changes.
Cancel	Click <b>Cancel</b> to discard the changes.

# CHAPTER 33

## Maintenance

### 33.1 Firmware Upgrade

#### 33.1.1 Overview

Firmware updates contain bug fixes and fixes for security vulnerabilities. It is recommended to keep the Switch's firmware up to date. You can upgrade the Switch's firmware manually using a file downloaded on your computer or through the online Web Configurator.

Note: Be sure to upload the correct model firmware as uploading the wrong model firmware may damage your device.

From the **Maintenance** screen, display the **Upload** screen as shown next. Use this screen to upgrade the Switch's firmware.

Figure 257 Maintenance > Firmware > Upload

Upload		<a href="#">Upload</a> <a href="#">Management</a>
Method	<input checked="" type="radio"/> TFTP <input type="radio"/> HTTP	
Server IP	<input type="text"/>	(IPv4 or IPv6 Address)
File Name	<input type="text"/>	
Image	<input type="radio"/> Active <input checked="" type="radio"/> Backup	
File Path	<input type="text"/> <input type="button" value="Browse"/>	
		<input type="button" value="Apply"/> <input type="button" value="Cancel"/>

The following table describes the labels under **Upload**.

Table 190 Maintenance > Firmware > Upload

LABEL	DESCRIPTION
Upload	
Method	Choose <b>HTTP</b> to use the Web Configurator for the firmware upload. Alternatively, choose <b>TFTP</b> to download the firmware from a TFTP server.
Server IP	To download from a TFTP server, enter the TFTP server IP address.
File Name	Enter the name of the firmware file on the TFTP server.
Image	Choose <b>Backup</b> to upload the firmware file as the backup image. Alternatively, choose <b>Active</b> to upload the firmware file as the active image.
File Path	Browse to the path on your computer to upload the firmware you want as the active image.

#### 33.1.2 Upgrade the firmware from a file on a server

Follow the steps below to upgrade the firmware from a TFTP server.

1. In **Method**, choose **TFTP**.
2. In **Server IP**, enter the TFTP server IP address.
3. In **File Name**, enter the name of the firmware file on the TFTP server.
4. In **Image**, choose **Backup** to upload the firmware file as the backup image.  
OR  
Choose **Active** to upload the firmware file as the active image.
5. Click **Apply** to upgrade the chosen image.  
OR  
Click **Cancel** to discard the changes.

After the firmware upgrade process is complete, see the **System Info** screen to verify your current firmware version number.

### 33.1.3 Upgrade the firmware from a file on your computer

Note: For manual upgrade, make sure you have downloaded (and unzipped) the correct model firmware and version to your computer before uploading it to the device. The file name should have a .bix extension.

Follow the steps below to upgrade the firmware from a file on your computer.

1. In **Method**, choose **HTTP**.
2. In **Image**, choose **Active** to upload the firmware file on the active partition image.  
OR  
Choose **Backup** to upload the firmware file on the backup partition image.
3. In **File Path**, click **Browse** to display the **Choose File** screen from which you can locate the firmware file in the bix format on your computer.
4. Click **Apply** to upload the chosen file.  
OR  
Click **Cancel** to discard the changes.

After the firmware upgrade process is complete, see the **System Info** screen to verify your current firmware version number.

## 33.2 Firmware Management

### 33.2.1 Overview

The Firmware Management screen provides instant access to the firmware versions installed on your Switch. Active and backup firmware versions are saved as images on flash partitions. The backup image is used when the active partition has problems during boot.

From the **Maintenance** screen, display the **Firmware Management** screen as shown next. Use this screen to view image information and activate an image.

Figure 258 Maintenance &gt; Firmware &gt; Management

The screenshot shows the 'Image Select' configuration page. At the top, there are links for 'Upload' and 'Management'. The 'Active Image' section contains two radio buttons, both selected, pointing to 'V2.70(AAZI.0)B1\_20210630 | 06/30/2021'. Below this are 'Apply' and 'Cancel' buttons. The 'Images Information' section contains two tables:

V2.70(AAZI.0)B1_20210630   06/30/2021		Active
Flash Partition		0
Image Size		5995982 Bytes
Created Time		2021-06-30 09:45:54 UTC

V2.70(AAZI.0)B1_20210630   06/30/2021		Backup
Flash Partition		1
Image Size		5995982 Bytes
Created Time		2021-06-30 09:45:54 UTC

The following table describes the labels shown under **Images Information**.

Table 191 Maintenance &gt; Firmware &gt; Management

LABEL	DESCRIPTION
Image Select	
Active Image	Select which firmware should load, click <b>Apply</b> and reboot the Switch to see changes.
Apply	Click <b>Apply</b> to save the changes.
Cancel	Click <b>Cancel</b> to discard the changes.
Images Information	
Flash Partition	Displays the partition number.
Image Size	Displays the size of the partition image in bytes.
Created Time	Displays the date and time when the image was created in the Coordinated Universal Time (UTC) format.

### 33.2.2 Select the Active Image

The available partition is shown under **Image Select**.

Follow the steps below to choose the active image, which will be the default partition during boot. When you selected the active image and saved the changes, the other one will be the backup.

If you are facing problems with the active partition when booting, the Switch will use the backup one and it'll be loaded automatically.

1. In **Active Image**, choose the backup image according to the information displayed in **Images Information**.
2. Click **Apply** to activate the backup image.  
OR  
Click **Cancel** to discard the changes.



## 33.3 Backup a Configuration File

### 33.3.1 Overview

You can save various "snapshots" of your device to the server or your computer and restore them at a later date, if required.

Click **Maintenance > Configuration > Backup** to display the screen as shown next. Use this screen to back up your current Switch configuration and log files to a server or as local files to your computer.

**Figure 259** Maintenance > Configuration > Backup

The following table describes the labels under **Backup**.

Table 192 Maintenance > Configuration > Backup

LABEL	DESCRIPTION
Backup	
Method	Choose <b>HTTP</b> to use the Web Configurator to backup the configuration. Alternatively, choose <b>TFTP</b> to upload the snapshot to a TFTP server.
Server IP	To upload the backup to a TFTP server, enter the TFTP server IP address.
Content	<p>Choose the type of file for backup. You can back up configuration files (running, startup, or backup) or log files (flash or buffer).</p> <p>There are three different types of configuration files:</p> <p><b>Backup configuration</b> – this is saved in the Switch. If you make changes to the current configuration, and there are problems, you can revert to the Backup configuration without having to restore a new file.</p> <p><b>Startup configuration</b> – this is the configuration used when the Switch is booting up.</p> <p><b>Running configuration</b> – this is the configuration when the Switch is running.</p> <p>There are two different types of log files:</p> <p><b>Flash log:</b> Select this to save logs in the Switch's flash (permanent) memory.</p> <p><b>Buffer log:</b> Select this to save logs in the Switch's memory buffer. If the logs are stored in the Switch's memory buffer, the logs will be erased when the Switch reboots.</p> <p><b>Tech Support:</b> Select this to upload the configuration/log files to the TFTP server. The log files contain useful information such as CPU utilization, history, memory and Mbuf (Memory Buffer) log, and crash reports for issue analysis by customer support should you have difficulty with your Switch.</p>
Apply	Click <b>Apply</b> to save the changes.
Cancel	Click <b>Cancel</b> to discard the changes.

### 33.3.2 Back up configuration or log files to a server

Follow the steps below to backup configuration or log files to a TFTP server.

1. In **Method**, choose **TFTP**.
2. In **Server IP**, enter the TFTP server IP address.
3. In **Content**, choose any one file type.
4. Click **Apply** to save a snapshot of your current configuration to the TFTP server.  
OR  
Click **Cancel** to discard the changes.

### 33.3.3 Back up configuration or log files to your computer

Follow the steps below to backup configuration or log files to your computer.

1. In **Method**, choose **HTTP**.
2. In **Content**, choose any one file type.
3. Click **Apply** to display the **Save File** screen from which you can save the configuration file in the cfg format or the log file in the log format to your computer.  
OR  
Click **Cancel** to discard the changes.

## 33.4 Restore a Configuration File

### 33.4.1 Overview

You can restore a previously saved device configuration from the server or your computer.

Click **Maintenance > Configuration > Restore** to display the screen as shown next. Use this screen to restore a previously saved configuration from a server or your computer.

**Figure 260** Maintenance > Configuration > Restore

The following table describes the labels under **Configuration Restore**.

Table 193 Maintenance > Configuration > Restore

LABEL	DESCRIPTION
Configuration Restore	
Method	Choose <b>HTTP</b> to use the Web Configurator for restoring the configuration file. Alternatively, choose <b>TFTP</b> to download the snapshot from a TFTP server.
Server IP	To download from a TFTP server, enter the TFTP server IP address.

Table 193 Maintenance &gt; Configuration &gt; Restore (continued)

LABEL	DESCRIPTION
File Name	Enter the name of the configuration file on the TFTP server.
File Path	Browse to the path on your computer to upload the configuration you want to restore.
Apply	Click <b>Apply</b> to save the changes.
Cancel	Click <b>Cancel</b> to discard the changes.

### 33.4.2 Restore the configuration from a file on a server

Follow the steps below to restore the configuration from a server.

1. In **Method**, choose **TFTP**.
2. In **Server IP**, enter the TFTP server IP address.
3. In **File Name**, enter the name of the configuration file on the TFTP server.
4. Click **Apply** to restore to the chosen file as the running configuration.  
OR  
Click **Cancel** to discard the changes.

### 33.4.3 Restore the configuration from a file on your computer

Follow the steps below to restore the configuration from a file on your computer.

1. In **Method**, choose **HTTP**.
2. In **File Path**, click **Browse** to display the **Choose File** screen from which you can locate the configuration file in the cfg format on your computer.
3. Click **Apply** to restore to the chosen file as the running configuration.  
OR  
Click **Cancel** to discard the changes.

## 33.5 Manage Configuration Files

### 33.5.1 Overview

The Configuration Management screen provides instant access to the configuration files of your Switch. You can overwrite the startup and backup configurations with the current running, startup, or backup configuration file.

Click **Maintenance > Configuration > Management** to display the screen as shown next. Use this screen to replace startup and backup configuration files.

**Figure 261** Maintenance > Configuration > Management

File Management	Backup	Restore	Management	Factory Default
Source File	<input type="radio"/> Running configuration	<input type="radio"/> Startup configuration	<input type="radio"/> Backup configuration	
Destination File	<input type="radio"/> Startup configuration	<input type="radio"/> Backup configuration		
<input type="button" value="Apply"/> <input type="button" value="Cancel"/>				

Follow the steps to overwrite the startup or backup configuration file.

1. In **Source File**, select the file to be used as a reference.
2. In **Destination File**, select the file to be overwritten.
3. Click **Apply** to restore to overwrite the destination file with the source file.  
OR  
Click **Cancel** to discard the changes.

## 33.6 Reset to Factory Defaults

### 33.6.1 Overview

You can reset the Switch to its original settings.

Click **Maintenance > Configuration > Factory Default** to display the screen as shown next. Use this screen to reset the Switch back to factory defaults.

Table 194 Maintenance &gt; Configuration &gt; Factory Default

Restore Factory Default	Backup	Restore	Management	Factory Default
This would reset the configuration to factory default and will reboot the system.				
<input type="button" value="Restore"/>				

### 33.6.2 Reset the Switch to Factory Defaults

Follow the steps below to reset the Switch back to factory defaults.

1. Click **Restore**.
2. Click **OK** to reset all Switch configurations to the factory defaults. Wait for the Switch to restart. This takes up to 2 minutes.  
OR  
Click **Cancel** to discard the changes.

Note: If you want to access the Switch Web Configurator again, you may need to change the IP address of your computer to be in the same subnet as that of the default Switch IP address (192.168.1.1).

## 33.7 Network Diagnostics

Use the network utilities to perform diagnostics.

### 33.7.1 Port Test

Click **Maintenance > Diagnostics > Port Test > Cable Diag** in the navigation panel to open this screen. Use this screen to perform an internal loop-back test on an Ethernet port.

Note: The Switch measures the cable length by sending an electric signal through the cable and reading the signal that is reflected back. To prevent possible interference from a connected device, it is suggested that you disconnect the other end of the Ethernet cable which is connected to the specified port.

**Figure 262** Maintenance > Diagnostics > Port Test > Cable Diag

Cable Diag	
Port	1
<input type="button" value="Test"/>	
Service will stop a while if do it !	
Test Result	
Port	Result

Follow the steps to perform the port test.

1. In **Port Test**, select the port number from the **Port** drop-down list.
2. Click **Test** to start the port test.

The test results are displayed in **Test Results**.

### 33.7.2 IPv4 Ping Test

Click **Maintenance > Diagnostics > PING > IPv4** in the navigation panel to open this screen. Use this screen to ping an IPv4 server.

**Figure 263** Maintenance > Diagnostics > PING > IPv4

Ping Test		IPv4	IPv6
IP Address	192.168.1.100	(x.x.x.x or hostname)	
Count	4	(1 - 5)	
Interval	1	(1 - 5 sec)	
Size	56	(8 - 5120 byte)	
Result			
<input type="button" value="Apply"/> <input type="button" value="Cancel"/>			

The following table describes the labels under **Ping Test**.

Table 195 Maintenance &gt; Diagnostics &gt; PING &gt; IPv4

LABEL	DESCRIPTION
Ping Test	
IP Address	Enter the address of the target host server.
Count	Enter the number of ping packets to send. The range is 1 to 5 packets; the default count is 4.
Interval	Enter the time in seconds between sending ping packets. The range is 1 to 5 seconds; the default is 1 second.
Size	Enter the individual packet size in bytes. The range is 8 to 5120 bytes; the default is 56 bytes.
Apply	Click <b>Apply</b> to save the changes.
Cancel	Click <b>Cancel</b> to discard the changes.

Follow the steps to perform a ping test.

1. In **IP Address**, enter the IPv4 address.
2. In **Count**, enter the number of ping packets.
3. In **Interval**, enter the time interval in seconds.
4. In **Size**, enter the packet size in bytes
5. Click **Apply** to perform the ping test.  
OR  
Click **Cancel** to discard the changes.

The test results are displayed in **Results**.

### 33.7.3 IPv6 Ping Test

Click **Maintenance > Diagnostics > PING > IPv6** in the navigation panel to open this screen. Use this screen to ping an IPv6 server.

**Figure 264** Maintenance > Diagnostics > PING > IPv6

The following table describes the labels in **IPv6 Ping Test**.

Table 196 Maintenance > Diagnostics > PING > IPv6

LABEL	DESCRIPTION
IPv6 Ping Test	
IPv6 Address	Enter the address of the target host server.
Count	Enter the number of ping packets to send. The range is <b>1</b> to <b>5</b> packets; the default count is <b>4</b> .
Interval	Enter the time in seconds between sending ping packets. The range is <b>1</b> to <b>5</b> seconds; the default is <b>1</b> second.
Size	Enter the individual packet size in bytes. The range is <b>8</b> to <b>5120</b> bytes; the default is <b>56</b> bytes.
Apply	Click <b>Apply</b> to save the changes.
Cancel	Click <b>Cancel</b> to discard the changes.

Follow the steps to perform a ping test.

1. In **IPv6 Address**, enter the IPv6 address.
  2. In **Count**, enter the number of ping packets.
  3. In **Interval**, enter the time interval in seconds.
  4. In **Size**, enter the packet size in bytes.
  5. Click **Apply** to perform the ping test.
- OR

Click **Cancel** to discard the changes.

The test results are displayed in **Results**.

### 33.7.4 Trace Route

Click **Maintenance > Diagnostics > Trace > Trace Route** in the navigation panel to open this screen. Use this screen to print the route that IP packets take to a network host.

**Figure 265** Maintenance > Diagnostics > Trace > Trace Route

The following table describes the labels in **Trace Route**.

Table 197 Maintenance > Diagnostics > Trace > Trace Route

LABEL	DESCRIPTION
Trace Route	
IP Address	Enter the address of the target host server.
Hops	Enter the maximum number of time-to-live or hops used in outgoing probe packets. The range is <b>2</b> to <b>255</b> packets; the default is <b>30</b> hops.
Apply	Click <b>Apply</b> to save the changes.
Cancel	Click <b>Cancel</b> to discard the changes.

Follow the steps to perform a trace route.

1. In **IP Address**, enter the IPv6 address.
2. In **Hops**, enter the number of hops.
3. Click **Apply** to perform the test.  
OR  
Click **Cancel** to discard the changes.

The test results are displayed in **Result**.



## 33.8 Reboot

### 33.8.1 Overview

You can reboot the Switch from the Web Configurator.

Click **Maintenance** > **Reboot** in the navigation panel to open this screen. Use this screen to restart the Switch without physically turning the power off.

**Figure 266** Maintenance > Reboot

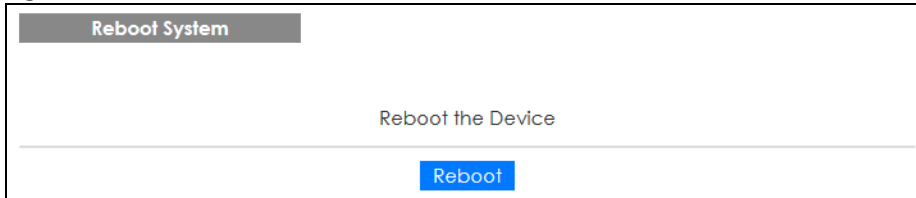

### 33.8.2 Reboot the Switch

Follow the steps below to restart the Switch.

1. Click **Reboot**.
2. Click **OK** and then wait for the Switch to restart. This process takes up to 2 minutes and does not affect the Switch's configuration.  
OR  
Click **Cancel** to discard the changes.

# CHAPTER 34

## Troubleshooting

This chapter offers some suggestions to solve problems you might encounter. The potential problems are divided into the following categories.

- [Power, Hardware Connections, and LEDs](#)
- [Switch Access and Login](#)
- [Switch Configuration](#)

### 34.1 Power, Hardware Connections, and LEDs

---

[The Switch does not turn on. None of the LEDs turn on.](#)

---

- 1 Make sure the Switch is turned on (in DC models or if the DC power supply is connected in AC/DC models).
- 2 Make sure you are using the power adapter or cord included with the Switch.
- 3 Make sure the power adapter or cord is connected to the Switch and plugged in to an appropriate power source. Make sure the power source is turned on.
- 4 Turn the Switch off and on (in DC models or if the DC power supply is connected in AC/DC models).
- 5 Disconnect and re-connect the power adapter or cord to the Switch (in AC models or if the AC power supply is connected in AC/DC models).
- 6 If the problem continues, contact the vendor.

[One of the LEDs does not behave as expected.](#)

---

- 1 Make sure you understand the normal behavior of the LED. See [Section 3.3 on page 41](#).
- 2 Check the hardware connections. See [Chapter 2 on page 25](#).
- 3 Inspect your cables for damage. Contact the vendor to replace any damaged cables.
- 4 Turn the Switch off and on (in DC models or if the DC power supply is connected in AC/DC models).
- 5 Disconnect and re-connect the power adapter or cord to the Switch (in AC models or if the AC power

supply is connected in AC/DC models).

- 6 If the problem continues, contact the vendor.

## 34.2 Switch Access and Login

---

### I forgot the IP address for the Switch.

---

- 1 The default in-band IP address is **192.168.1.1** or **http://DHCP-assigned IP** (when connecting to a DHCP server).
  - 2 If this does not work, you have to reset the device to its factory defaults. See [Section 3.4 on page 43](#) or [Section 33.6 on page 244](#).
- 

### I forgot the user name and/or password.

---

- 1 The default user name is **admin** and the default password is **1234**.
  - 2 If this does not work, you have to reset the device to its factory defaults. See [Section 3.4 on page 43](#) or [Section 33.6 on page 244](#).
- 

### I cannot see or access the **Login** screen in the Web Configurator.

---

- 1 Make sure you are using the correct IP address.
    - The default in-band IP address is **192.168.1.1**.
    - If you changed the IP address, use the new IP address.
    - If you changed the IP address and have forgotten it, see the troubleshooting suggestions for [I forgot the IP address for the Switch](#).
  - 2 Check the hardware connections, and make sure the LEDs are behaving as expected. See [Chapter 2 on page 25](#).
  - 3 Make sure your Internet browser does not block pop-up windows and has JavaScripts and Java enabled.
  - 4 Make sure your computer is in the same subnet as the Switch. (If you know that there are routers between your computer and the Switch, skip this step.)
  - 5 Reset the device to its factory defaults, and try to access the Switch with the default IP address. See [Section 3.4 on page 43](#) or [Section 33.6 on page 244](#).
-

- 6 If the problem continues, contact the vendor, or try one of the advanced suggestions.

#### Advanced Suggestions

- Try to access the Switch using another service, such as HTTPS. If you can access the Switch, check the remote management settings to find out why the Switch does not respond to HTTP.

---

I can see the [Login](#) screen, but I cannot log in to the Switch.

---

- 1 Make sure you have entered the user name and password correctly. The default user name is **admin**, and the default password is **1234**. These fields are case-sensitive, so make sure [Caps Lock] is not on.
- 2 Check that you have enabled logins for HTTP. If you have configured a secured client IP address, your computer's IP address must match it. Refer to the chapter on access control for details.
- 3 Disconnect and re-connect the cord to the Switch.
- 4 If this does not work, you have to reset the device to its factory defaults. See [Section 3.4 on page 43](#) or [Section 33.6 on page 244](#).

---

[Pop-up Windows, JavaScripts and Java Permissions](#)

---

In order to use the Web Configurator you need to allow:

- Web browser pop-up windows from your device.
- JavaScripts (enabled by default).
- Java permissions (enabled by default).

## 34.3 Switch Configuration

---

[I lost my configuration settings after I restart the Switch.](#)

---

Make sure you save your configuration into the Switch's non-volatile memory each time you make changes. Click **Save** at the top right corner of the Web Configurator to save the configuration permanently. See also [Section 5.3.1 on page 52](#) for more information about how to save your configuration.



# APPENDIX A

## Customer Support

In the event of problems that cannot be solved by using this manual, you should contact your vendor. If you cannot contact your vendor, then contact a Zyxel office for the region in which you bought the device.

For Zyxel Communication offices, see <https://service-provider.zyxel.com/global/en/contact-us> for the latest information.

For Zyxel Network offices, see <https://www.zyxel.com/index.shtml> for the latest information.

Please have the following information ready when you contact an office.

### Required Information

- Product model and serial number.
- Warranty Information.
- Date that you received your device.
- Brief description of the problem and the steps you took to solve it.

### Corporate Headquarters (Worldwide)

#### Taiwan

- Zyxel Communications Corporation
- <https://www.zyxel.com>

### Asia

#### China

- Zyxel Communications (Shanghai) Corp.
- Zyxel Communications (Beijing) Corp.
- Zyxel Communications (Tianjin) Corp.
- <https://www.zyxel.com/cn/zh/>

#### India

- Zyxel Technology India Pvt Ltd.
- <https://www.zyxel.com/in/en/>

#### Kazakhstan

- Zyxel Kazakhstan
- <https://www.zyxel.kz>

## **Korea**

- Zyxel Korea Corp.
- <http://www.zyxel.kr>

## **Malaysia**

- Zyxel Malaysia Sdn Bhd.
- <http://www.zyxel.com.my>

## **Pakistan**

- Zyxel Pakistan (Pvt.) Ltd.
- <http://www.zyxel.com.pk>

## **Philippines**

- Zyxel Philippines
- <http://www.zyxel.com.ph>

## **Singapore**

- Zyxel Singapore Pte Ltd.
- <http://www.zyxel.com.sg>

## **Taiwan**

- Zyxel Communications Corporation
- <https://www.zyxel.com/tw/zh/>

## **Thailand**

- Zyxel Thailand Co., Ltd.
- <https://www.zyxel.com/th/th/>

## **Vietnam**

- Zyxel Communications Corporation-Vietnam Office
- <https://www.zyxel.com/vn/vi>

## **Europe**

### **Belarus**

- Zyxel BY
- <https://www.zyxel.by>

### **Bulgaria**

- Zyxel България
- <https://www.zyxel.com/bg/bg/>

## **Czech Republic**

- Zyxel Communications Czech s.r.o
- <https://www.zyxel.com/cz/cs/>

## **Denmark**

- Zyxel Communications A/S
- <https://www.zyxel.com/dk/da/>

## **Finland**

- Zyxel Communications
- <https://www.zyxel.com/fi/fi/>

## **France**

- Zyxel France
- <https://www.zyxel.fr>

## **Germany**

- Zyxel Deutschland GmbH
- <https://www.zyxel.com/de/de/>

## **Hungary**

- Zyxel Hungary & SEE
- <https://www.zyxel.com/hu/hu/>

## **Italy**

- Zyxel Communications Italy
- <https://www.zyxel.com/it/it/>

## **Netherlands**

- Zyxel Benelux
- <https://www.zyxel.com/nl/nl/>

## **Norway**

- Zyxel Communications
- <https://www.zyxel.com/no/no/>

## **Poland**

- Zyxel Communications Poland
- <https://www.zyxel.com/pl/pl/>

## **Romania**

- Zyxel Romania

- <https://www.zyxel.com/ro/ro>

## **Russia**

- Zyxel Russia
- <https://www.zyxel.com/ru/ru/>

## **Slovakia**

- Zyxel Communications Czech s.r.o. organizacna zlozka
- <https://www.zyxel.com/sk/sk/>

## **Spain**

- Zyxel Communications ES Ltd.
- <https://www.zyxel.com/es/es/>

## **Sweden**

- Zyxel Communications
- <https://www.zyxel.com/se/sv/>

## **Switzerland**

- Studerus AG
- <https://www.zyxel.ch/de>
- <https://www.zyxel.ch/fr>

## **Turkey**

- Zyxel Turkey A.S.
- <https://www.zyxel.com/tr/tr/>

## **UK**

- Zyxel Communications UK Ltd.
- <https://www.zyxel.com/uk/en/>

## **Ukraine**

- Zyxel Ukraine
- <http://www.ua.zyxel.com>

## **South America**

### **Argentina**

- Zyxel Communications Corporation
- <https://www.zyxel.com/co/es/>



## **Brazil**

- Zyxel Communications Brasil Ltda.
- <https://www.zyxel.com/br/pt/>

## **Colombia**

- Zyxel Communications Corporation
- <https://www.zyxel.com/co/es/>

## **Ecuador**

- Zyxel Communications Corporation
- <https://www.zyxel.com/co/es/>

## **South America**

- Zyxel Communications Corporation
- <https://www.zyxel.com/co/es/>

## **Middle East**

### **Israel**

- Zyxel Communications Corporation
- <http://il.zyxel.com/>

## **North America**

### **USA**

- Zyxel Communications, Inc. – North America Headquarters
- <https://www.zyxel.com/us/en/>

# APPENDIX B

## Legal Information

### Copyright

Copyright © 2022 by Zyxel and/or its affiliates.

The contents of this publication may not be reproduced in any part or as a whole, transcribed, stored in a retrieval system, translated into any language, or transmitted in any form or by any means, electronic, mechanical, magnetic, optical, chemical, photocopying, manual, or otherwise, without the prior written permission of Zyxel and/or its affiliates.

Published by Zyxel and/or its affiliate. All rights reserved.

### Disclaimer

Zyxel does not assume any liability arising out of the application or use of any products, or software described herein. Neither does it convey any license under its patent rights nor the patent rights of others. Zyxel further reserves the right to make changes in any products described herein without notice. This publication is subject to change without notice.

### Regulatory Notice and Statement (Class A)

Model List: GS1900-8 (Revision B1), GS1900-8HP (Revision A1, B2), GS1900-10HP (Revision B1), GS1900-16 (Revision B1), GS1900-24, GS1900-24E (Revision B1), GS1900-24EP, GS1900-24HP/GS1900-24HPv2, GS1900-48, GS1900-48HP/GS1900-48HPv2

### United States of America



The following information applies if you use the product within USA area.

#### Federal Communications Commission (FCC) EMC Statement

- This device complies with Part 15 of FCC rules. Operation is subject to the following two conditions:
  - (1) This device may not cause harmful interference.
  - (2) This device must accept any interference received, including interference that may cause undesired operations.
- Changes or modifications not expressly approved by the party responsible for compliance could void the user's authority to operate the equipment.
- This equipment has been tested and found to comply with the limits for a Class A digital device, pursuant to part 15 of the FCC Rules. These limits are designed to provide reasonable protection against harmful interference when the equipment is operated in a commercial environment. This equipment generates, uses, and can radiate radio frequency energy and, if not installed and used in accordance with the instruction manual, may cause harmful interference to radio communications. Operation of this equipment in a residential area is likely to cause harmful interference in which case the user will be required to correct the interference at his own expense.

### Canada

The following information applies if you use the product within Canada area

#### Industry Canada ICES statement

CAN ICES-3 (A)/NMB-3(A)

### European Union and United Kingdom



The following information applies if you use the product within the European Union and United Kingdom.

#### EMC statement

WARNING: This equipment is compliant with Class A of EN55032. In a residential environment this equipment may cause radio interference.

## List of National Codes

COUNTRY	ISO 3166 2 LETTER CODE	COUNTRY	ISO 3166 2 LETTER CODE
Austria	AT	Liechtenstein	LI
Belgium	BE	Lithuania	LT
Bulgaria	BG	Luxembourg	LU
Croatia	HR	Malta	MT
Cyprus	CY	Netherlands	NL
Czech Republic	CZ	Norway	NO
Denmark	DK	Poland	PL
Estonia	EE	Portugal	PT
Finland	FI	Romania	RO
France	FR	Serbia	RS
Germany	DE	Slovakia	SK
Greece	GR	Slovenia	SI
Hungary	HU	Spain	ES
Iceland	IS	Sweden	SE
Ireland	IE	Switzerland	CH
Italy	IT	Turkey	TR
Latvia	LV	United Kingdom	GB

## Safety Warnings

- Do not use this product near water, for example, in a wet basement or near a swimming pool.
- Do not expose your device to dampness, dust or corrosive liquids.
- Do not store things on the device.
- Do not obstruct the device ventilation slots as insufficient airflow may harm your device. For example, do not place the device in an enclosed space such as a box or on a very soft surface such as a bed or sofa.
- Do not install, use, or service this device during a thunderstorm. There is a remote risk of electric shock from lightning.
- Connect ONLY suitable accessories to the device.
- Do not open the device or unit. Opening or removing covers can expose you to dangerous high voltage points or other risks. Only qualified service personnel should service or disassemble this device. Please contact your vendor for further information.
- Make sure to connect the cables to the correct ports.
- Place connecting cables carefully so that no one will step on them or stumble over them.
- Always disconnect all cables from this device before servicing or disassembling.
- Do not remove the plug and connect it to a power outlet by itself; always attach the plug to the power adaptor first before connecting it to a power outlet.
- Do not allow anything to rest on the power adaptor or cord and do NOT place the product where anyone can walk on the power adaptor or cord.
- Please use the provided or designated connection cables/power cables/ adaptors. Connect it to the right supply voltage (for example, 110V AC in North America or 230V AC in Europe). If the power adaptor or cord is damaged, it might cause electrocution. Remove it from the device and the power source, repairing the power adapter or cord is prohibited. Contact your local vendor to order a new one.
- Do not use the device outside, and make sure all the connections are indoors. There is a remote risk of electric shock from lightning.
- Caution: Risk of explosion if battery is replaced by an incorrect type, dispose of used batteries according to the instruction. Dispose them at the applicable collection point for the recycling of electrical and electronic device. For detailed information about recycling of this product, please contact your local city office, your household waste disposal service or the store where you purchased the product.
- Use ONLY power wires of the appropriate wire gauge for your device. Connect it to a power supply of the correct voltage.
- Fuse Warning! Replace a fuse only with a fuse of the same type and rating.
- The POE (Power over Ethernet) devices that supply or receive power and their connected Ethernet cables must all be completely indoors.
- The following warning statements apply, where the disconnect device is not incorporated in the device or where the plug on the power supply cord is intended to serve as the disconnect device.
  - For permanently connected devices, a readily accessible disconnect device shall be incorporated external to the device;
  - For pluggable devices, the socket-outlet shall be installed near the device and shall be easily accessible.
- This equipment must be grounded by qualified service personnel. Never defeat the ground conductor or operate the equipment in the absence of a suitably installed ground conductor. Contact the appropriate electrical inspection authority or an electrician if you are uncertain that suitable grounding is available.
- If your device has an earthing screw (frame ground), connect the screw to a ground terminal using an appropriate AWG ground wire. Do this before you make other connections.
- If your device has no earthing screw, but has a 3-prong power plug, make sure to connect the plug to a 3-hole earthed socket.
- When connecting or disconnecting power to hot-pluggable power supplies, if offered with your system, observe the following guidelines:
  - Install the power supply before connecting the power cable to the power supply.
  - Unplug the power cable before removing the power supply.
  - If the system has multiple sources of power, disconnect power from the system by unplugging all power cables from the power supply.
- CLASS 1 LASER PRODUCT (for products with mini-GBIC slots or laser products, such as fiber-optic transceiver and GPON products).
- PRODUCT COMPLIES WITH 21 CFR 1040.10 AND 1040.11. (for products with mini-GBIC slots or laser products, such as fiber-optic transceiver and GPON products)

- APPAREIL À LASER DE CLASS 1 (for products with mini-GBIC slots or laser products, such as fiber-optic transceiver and GPON products).
- PRODUIT CONFORME SELON 21 CFR 1040.10 ET 1040.11. (for products with mini-GBIC slots or laser products, such as fiber-optic transceiver and GPON products)

## Environment Statement

### Disposal and Recycling Information

The symbol below means that according to local regulations your product and/or its battery shall be disposed of separately from domestic waste. If this product is end of life, take it to a recycling station designated by local authorities. At the time of disposal, the separate collection of your product and/or its battery will help save natural resources and ensure that the environment is sustainable development.

Die folgende Symbol bedeutet, dass Ihr Produkt und/oder seine Batterie gemäß den örtlichen Bestimmungen getrennt vom Hausmüll entsorgt werden muss. Wenden Sie sich an eine Recyclingstation, wenn dieses Produkt das Ende seiner Lebensdauer erreicht hat. Zum Zeitpunkt der Entsorgung wird die getrennte Sammlung von Produkt und/oder seiner Batterie dazu beitragen, natürliche Ressourcen zu sparen und die Umwelt und die menschliche Gesundheit zu schützen.

El símbolo de abajo indica que según las regulaciones locales, su producto y/o su batería deberán depositarse como basura separada de la doméstica. Cuando este producto alcance el final de su vida útil, llévelo a un punto limpio. Cuando llegue el momento de desechar el producto, la recogida por separado éste y/o su batería ayudará a salvar los recursos naturales y a proteger la salud humana y medioambiental.

Le symbole ci-dessous signifie que selon les réglementations locales votre produit et/ou sa batterie doivent être éliminés séparément des ordures ménagères. Lorsque ce produit atteint sa fin de vie, amenez-le à un centre de recyclage. Au moment de la mise au rebut, la collecte séparée de votre produit et/ou de sa batterie aidera à économiser les ressources naturelles et protéger l'environnement et la santé humaine.

Il simbolo sotto significa che secondo i regolamenti locali il vostro prodotto e/o batteria deve essere smaltito separatamente dai rifiuti domestici. Quando questo prodotto raggiunge la fine della vita di servizio portarlo a una stazione di riciclaggio. Al momento dello smaltimento, la raccolta separata del vostro prodotto e/o della sua batteria aiuta a risparmiare risorse naturali e a proteggere l'ambiente e la salute umana.

Symbolen innebär att enligt lokal lagstiftning ska produkten och/eller dess batteri kastas separat från hushållsavfallet. När den här produkten når slutet av sin livslängd ska du ta den till en återvinningsstation. Vid tiden för kasseringen bidrar du till en bättre miljö och mänsklig hälsa genom att göra dig av med den på ett återvinningsställe.



## 台灣

警告使用者：

- 這是甲類的資訊產品，在居住的環境中使用時，可能會造成射頻干擾，在這種情況下，使用者會被要求採取某些適當的對策。」

安全警告 – 為了您的安全，請先閱讀以下警告及指示：

- 請勿將此產品接近水、火焰或放置在高溫的環境。
- 避免設備接觸
  - 任何液體 - 切勿讓設備接觸水、雨水、高濕度、污水腐蝕性的液體或其他水份。
  - 灰塵及污物 - 切勿接觸灰塵、污物、沙土、食物或其他不合適的材料。
- 雷雨天氣時，不要安裝、使用或維修此設備。有遭受電擊的風險。
- 切勿重摔或撞擊設備，並勿使用不正確的電源變壓器。
- 若接上不正確的電源變壓器會有爆炸的風險。
- 請勿隨意更換產品內的電池。
- 如果更換不正確之電池型式，會有爆炸的風險，請依製造商說明書處理使用過之電池。
- 請將廢電池丟棄在適當的電器或電子設備回收處。
- 請勿將設備解體。
- 請勿阻礙設備的散熱孔，空氣對流不足將會造成設備損害。
- 請插在正確的電壓供給插座（如：北美 / 台灣電壓 110V AC，歐洲是 230V AC）。
- 假若電源變壓器或電源變壓器的纜線損壞，請從插座拔除，若您還繼續插電使用，會有觸電死亡的風險。
- 請勿試圖修理電源變壓器或電源變壓器的纜線，若有毀損，請直接聯絡您購買的店家，購買一個新的電源變壓器。

- 請勿將此設備安裝於室外。此設備僅適合放置於室內。
- 請勿隨一般垃圾丟棄。
- 請參閱產品背貼上的設備額定功率。
- 請參考產品型錄或是彩盒上的作業溫度。
- 設備必須接地。接地導線不允許被破壞或沒有適當安裝接地導線。如果不確定接地方式是否符合要求可聯繫相應的電氣檢驗機構檢驗。
- 如果您提供的系統中有提供熱插拔電源。連接或斷開電源請遵循以下指導原則
  - 先連接電源線至設備連。再連接電源。
  - 先斷開電源再拔除連接至設備的電源線。
  - 如果系統有多個電源。需拔除所有連接至電源的電源線再關閉設備電源。
- 產品沒有斷電裝置或者採用電源線的插頭視為斷電裝置的一部分。以下警語將適用：
  - 對永久連接之設備。在設備外部須安裝可觸及之斷電裝置；
  - 對插接式之設備。插座必須接近安裝之地點而且是易於觸及的。

## Regulatory Notice and Statement (Class B)

Model List: GS1900-8, GS1900-8HP (Revision B1), GS1900-10HP, GS1900-16, GS1900-24E

### UNITED STATES of AMERICA



The following information applies if you use the product within USA area.

#### FCC EMC Statement

- The device complies with Part 15 of FCC rules. Operation is subject to the following two conditions:
  - (1) This device may not cause harmful interference, and
  - (2) This device must accept any interference received, including interference that may cause undesired operation.
- Changes or modifications not expressly approved by the party responsible for compliance could void the user's authority to operate the device.
- This product has been tested and complies with the specifications for a Class B digital device, pursuant to Part 15 of the FCC Rules. These limits are designed to provide reasonable protection against harmful interference in a residential installation. This device generates, uses, and can radiate radio frequency energy and, if not installed and used according to the instructions, may cause harmful interference to radio communications. However, there is no guarantee that interference will not occur in a particular installation.
- If this device does cause harmful interference to radio or television reception, which is found by turning the device off and on, the user is encouraged to try to correct the interference by one or more of the following measures:
  - Reorient or relocate the receiving antenna
  - Increase the separation between the devices
  - Connect the equipment to an outlet other than the receiver's
  - Consult a dealer or an experienced radio/TV technician for assistance

### CANADA

The following information applies if you use the product within Canada area

#### Industry Canada ICES statement

CAN ICES-3 (B)/NMB-3(B)

### EUROPEAN UNION and UNITED KINGDOM



The following information applies if you use the product within the European Union and United Kingdom.

## List of national codes

COUNTRY	ISO 3166 2 LETTER CODE	COUNTRY	ISO 3166 2 LETTER CODE
Austria	AT	Liechtenstein	LI
Belgium	BE	Lithuania	LT
Bulgaria	BG	Luxembourg	LU
Croatia	HR	Malta	MT
Cyprus	CY	Netherlands	NL
Czech Republic	CZ	Norway	NO
Denmark	DK	Poland	PL
Estonia	EE	Portugal	PT
Finland	FI	Romania	RO
France	FR	Serbia	RS
Germany	DE	Slovakia	SK
Greece	GR	Slovenia	SI
Hungary	HU	Spain	ES
Iceland	IS	Switzerland	CH
Ireland	IE	Sweden	SE
Italy	IT	Turkey	TR
Latvia	LV	United Kingdom	GB

## Safety Warnings

- Do not use this product near water, for example, in a wet basement or near a swimming pool.
- Do not expose your device to dampness, dust or corrosive liquids.
- Do not store things on the device.
- Do not obstruct the device ventilation slots as insufficient airflow may harm your device. For example, do not place the device in an enclosed space such as a box or on a very soft surface such as a bed or sofa.
- Do not install, use, or service this device during a thunderstorm. There is a remote risk of electric shock from lightning.
- Connect ONLY suitable accessories to the device.
- Do not open the device or unit. Opening or removing covers can expose you to dangerous high voltage points or other risks. ONLY qualified service personnel should service or disassemble this device. Please contact your vendor for further information.
- Make sure to connect the cables to the correct ports.
- Place connecting cables carefully so that no one will step on them or stumble over them.
- Always disconnect all cables from this device before servicing or disassembling.
- Do not remove the plug and connect it to a power outlet by itself; always attach the plug to the power adaptor first before connecting it to a power outlet.
- Do not allow anything to rest on the power adaptor or cord and do NOT place the product where anyone can walk on the power adaptor or cord.
- Please use the provided or designated connection cables/power cables/ adaptors. Connect it to the right supply voltage (for example, 110V AC in North America or 230V AC in Europe). If the power adaptor or cord is damaged, it might cause electrocution. Remove it from the device and the power source, repairing the power adapter or cord is prohibited. Contact your local vendor to order a new one.
- Do not use the device outside, and make sure all the connections are indoors. There is a remote risk of electric shock from lightning.
- CAUTION: Risk of explosion if battery is replaced by an incorrect type, dispose of used batteries according to the instruction. Dispose them at the applicable collection point for the recycling of electrical and electronic devices. For detailed information about recycling of this product, please contact your local city office, your household waste disposal service or the store where you purchased the product.
- The following warning statements apply, where the disconnect device is not incorporated in the device or where the plug on the power supply cord is intended to serve as the disconnect device,
  - For permanently connected devices, a readily accessible disconnect device shall be incorporated external to the device;
  - For pluggable devices, the socket-outlet shall be installed near the device and shall be easily accessible.
- CLASS 1 LASER PRODUCT (for products with mini-GBIC slots or laser products, such as fiber-optic transceiver and GPON products).
- PRODUCT COMPLIES WITH 21 CFR 1040.10 AND 1040.11. (for products with mini-GBIC slots or laser products, such as fiber-optic transceiver and GPON products)
- APPAREIL À LASER DE CLASS 1 (for products with mini-GBIC slots or laser products, such as fiber-optic transceiver and GPON products).
- PRODUIT CONFORME SELON 21 CFR 1040.10 ET 1040.11. (for products with mini-GBIC slots or laser products, such as fiber-optic transceiver and GPON products)

## Environment Statement

## ErP (Energy-related Products)

Zyxel products put on the EU and United Kingdom market in compliance with the requirement of the European Parliament and the Council published Directive 2009/125/EC and UK regulation establishing a framework for the setting of ecodesign requirements for energy-related products (recast), so called as "ErP Directive (Energy-related Products directive) as well as ecodesign requirement laid down in applicable implementing measures, power consumption has satisfied regulation requirements which are:

- Network standby power consumption < 8W, and/or

- Off mode power consumption < 0.5W, and/or
- Standby mode power consumption < 0.5W.

### Disposal and Recycling Information

The symbol below means that according to local regulations your product and/or its battery shall be disposed of separately from domestic waste. If this product is end of life, take it to a recycling station designated by local authorities. At the time of disposal, the separate collection of your product and/or its battery will help save natural resources and ensure that the environment is sustainable development.

Die folgende Symbol bedeutet, dass Ihr Produkt und/oder seine Batterie gemäß den örtlichen Bestimmungen getrennt vom Hausmüll entsorgt werden muss. Wenden Sie sich an eine Recyclingstation, wenn dieses Produkt das Ende seiner Lebensdauer erreicht hat. Zum Zeitpunkt der Entsorgung wird die getrennte Sammlung von Produkt und/oder seiner Batterie dazu beitragen, natürliche Ressourcen zu sparen und die Umwelt und die menschliche Gesundheit zu schützen.

El símbolo de abajo indica que según las regulaciones locales, su producto y/o su batería deberán depositarse como basura separada de la doméstica. Cuando este producto alcance el final de su vida útil, llévelo a un punto limpio. Cuando llegue el momento de desechar el producto, la recogida por separado éste y/o su batería ayudará a salvar los recursos naturales y a proteger la salud humana y medioambiental.

Le symbole ci-dessous signifie que selon les réglementations locales votre produit et/ou sa batterie doivent être éliminés séparément des ordures ménagères. Lorsque ce produit atteint sa fin de vie, amenez-le à un centre de recyclage. Au moment de la mise au rebut, la collecte séparée de votre produit et/ou de sa batterie aidera à économiser les ressources naturelles et protéger l'environnement et la santé humaine.

Il simbolo sotto significa che secondo i regolamenti locali il vostro prodotto e/o batteria deve essere smaltito separatamente dai rifiuti domestici. Quando questo prodotto raggiunge la fine della vita di servizio portarlo a una stazione di riciclaggio. Al momento dello smaltimento, la raccolta separata del vostro prodotto e/o della sua batteria aiuta a risparmiare risorse naturali e a proteggere l'ambiente e la salute umana.

Symbolen innebär att enligt lokal lagstiftning ska produkten och/eller dess batteri kastas separat från hushållsavfallet. När den här produkten når slutet av sin livslängd ska du ta den till en återvinningsstation. Vid tiden för kasseringen bidrar du till en bättre miljö och mänsklig hälsa genom att göra dig av med den på ett återvinningsställe.



## 台灣





安全警告 – 為了您的安全，請先閱讀以下警告及指示：

- 請勿將此產品接近水、火焰或放置在高溫的環境。
- 避免設備接觸任何液體 – 切勿讓設備接觸水、雨水、高濕度、污水腐蝕性的液體或其他水份。
- 灰塵及污物 – 切勿接觸灰塵、污物、沙土、食物或其他不合適的材料。
- 雷雨天氣時，不要安裝、使用或維修此設備。有遭受電擊的風險。
- 切勿重摔或撞擊設備，並勿使用不正確的電源變壓器。
- 若接上不正確的電源變壓器會有爆炸的風險。
- 請勿隨意更換產品內的電池。
- 如果更換不正確之電池型式，會有爆炸的風險，請依製造商說明書處理使用過之電池。
- 請將廢電池丟棄在適當的電器或電子設備回收處。
- 請勿將設備解體。
- 請勿阻礙設備的散熱孔，空氣對流不足將會造成設備損害。
- 請插在正確的電壓供給插座（如：北美 / 台灣電壓 110 V AC，歐洲是 230 V AC）。
- 假若電源變壓器或電源變壓器的纜線損壞，請從插座拔除，若您還繼續插電使用，會有觸電死亡的風險。
- 請勿試圖修理電源變壓器或電源變壓器的纜線，若有毀損，請直接聯絡您購買的店家，購買一個新的電源變壓器。
- 請勿將此設備安裝於室外，此設備僅適合放置於室內。
- 請勿隨一般垃圾丟棄。
- 請參閱產品背貼上的設備額定功率。
- 請參考產品型錄或是彩盒上的作業溫度。
- 產品沒有斷電裝置或者採用電源線的插頭視為斷電裝置的一部分，以下警語將適用：
  - 對永久連接之設備，在設備外部須安裝可觸及之斷電裝置；
  - 對插接式之設備，插座必須接近安裝之地點而且是易於觸及的。

## About the Symbols

Various symbols are used in this product to ensure correct usage, to prevent danger to the user and others, and to prevent property damage. The meaning of these symbols are described below. It is important that you read these descriptions thoroughly and fully understand the contents.

### Explanation of the Symbols

SYMBOL	EXPLANATION
	Alternating current (AC): AC is an electric current in which the flow of electric charge periodically reverses direction.
	Direct current (DC): DC is the unidirectional flow or movement of electric charge carriers.
	Earth; ground: A wiring terminal intended for connection of a Protective Earthing Conductor.
	Class II equipment: The method of protection against electric shock in the case of class II equipment is either double insulation or reinforced insulation.

### Viewing Certifications

Go to <http://www.zyxel.com> to view this product's documentation and certifications.

### Zyxel Limited Warranty

Zyxel warrants to the original end user (purchaser) that this product is free from any defects in material or workmanship for a specific period (the Warranty Period) from the date of purchase. The Warranty Period varies by region. Check with your vendor and/or the authorized Zyxel local distributor for details about the Warranty Period of this product. During the warranty period, and upon proof of purchase, should the product have indications of failure due to faulty workmanship and/or materials, Zyxel will, at its discretion, repair or replace the defective products or components without charge for either parts or labor, and to whatever extent it shall deem necessary to restore the product or components to proper operating condition. Any replacement will consist of a new or re-manufactured functionally equivalent product of equal or higher value, and will be solely at the discretion of Zyxel. This warranty shall not apply if the product has been modified, misused, tampered with, damaged by an act of God, or subjected to abnormal working conditions.

#### Note

Repair or replacement, as provided under this warranty, is the exclusive remedy of the purchaser. This warranty is in lieu of all other warranties, express or implied, including any implied warranty of merchantability or fitness for a particular use or purpose. Zyxel shall in no event be held liable for indirect or consequential damages of any kind to the purchaser.

To obtain the services of this warranty, contact your vendor. You may also refer to the warranty policy for the region in which you bought the device at [http://www.zyxel.com/web/support\\_warranty\\_info.php](http://www.zyxel.com/web/support_warranty_info.php).

### Registration

Register your product on-line at [www.zyxel.com](http://www.zyxel.com) to receive email notices of firmware upgrades and related information.

### Trademarks

The trademarks mentioned in this publication are used for identification purposes only and may be properties of their respective owners.

### Open Source Licenses

This product may contain in part some free software distributed under GPL license terms and/or GPL like licenses. To request the source code covered under these licenses, please go to: [https://www.zyxel.com/form/gpl\\_oss\\_software\\_notice.shtml](https://www.zyxel.com/form/gpl_oss_software_notice.shtml)



## Numbers

- 10/100/1000 Mbps gigabit Ethernet [33](#)
- 1000Base-T Ethernet port [33](#)
- 19-inch rack [28](#)
- 802.1x port authentication [89](#)

## A

- AAA (authentication, authorization and accounting) [216](#)
- AC power ground [39](#)
- access [50](#)
- ACKnowledgment (ACK) [215](#)
- Add Filtering MAC screen [151](#)
- Add OUI screen [147](#)
- administrator password [51](#)
- air circulation
  - desktop installation [26](#)
  - for cooling [25](#)
- altitude [193](#)
- application
  - backbone [21](#)
  - bridging [21](#)
  - fiber-optic uplink [21](#)
  - IEEE 802.1Q VLAN [22](#)
  - PoE [20](#)
- Auth Method screen [216](#)
- Authenticated Hosts screen [116](#)
- authentication [216](#)
- authentication failure traps [229](#)
- authentication method [232](#)
  - select [232](#)
- authentication password [228](#)
- authentication protocol [228](#)
  - display [227](#)
- authorized technician
  - install the Switch [25](#)
- auto configuration [75, 121](#)

- auto-crossover (auto-MDI/MDI-X) port [33](#)
- auto-negotiating port [33](#)

## B

- back up configuration files
  - to a server [242](#)
  - to your computer [242](#)
- back up log files
  - to a server [242](#)
  - to your computer [242](#)
- backbone [21](#)
- backup configuration file
  - overwrite [244](#)
- Backup screen [241](#)
- bandwidth contention
  - alleviate [21](#)
- Bandwidth Control screen [83](#)
- Bandwidth Utilization screen [80](#)
- BPDU (Bridge Protocol Data Unit) [180](#)
- bracket
  - for mounting [28](#)
- bridge protocol data unit (BPDU) [178](#)
- broadcast [100, 169](#)
- broadcast packet [136](#)
- broadcast storm control [135](#)
- bug fixes [238](#)
- button
  - PoE mode [36](#)
  - RESET [43](#)
  - RESTORE [43](#)

## C

- Cable Diag screen [245](#)
- cable length
  - measure [245](#)
- certifications [262](#)

- viewing [264](#)
- CIST Instance screen [104, 180](#)
- CIST Port screen [105, 181](#)
- Class of Service (CoS) [201](#)
- clearance
  - for ventilation hole [25](#)
  - Switch installation [25](#)
- Common and Internal Spanning Tree (CIST) [104](#)
- Community screen [224](#)
- comparison table
  - hardware version [18](#)
  - Switch [19](#)
- configuration file
  - back up [241](#)
  - manage [243](#)
  - restore [242](#)
- Configuration menu
  - Web Configurator [55](#)
- Configuration Restore screen [242](#)
- connection speed
  - SFP transceiver [34](#)
- contact information [253](#)
- cookies [50](#)
- Coordinated Universal Time (UTC) format [240](#)
- copyright [258](#)
- CoS Mapping screen [201](#)
- country code [193](#)
- crossover Ethernet cable [33](#)
- current date/time [62](#)
- customer support [253](#)

## D

- Daylight Saving Time [122](#)
- Denial of Service (DoS) attack [213](#)
- destination lookup failure (DLF) [135](#)
- DHCP setting [121](#)
- DHCP state [74](#)
- DHCPv6 client [23, 121](#)
- diagnostics
  - perform [245](#)
- disclaimer [258](#)
- DNS (Domain Name System) [63, 65, 75, 121](#)

- DNS server [75](#)
- DoS attack [213](#)
  - types [215](#)
- DoS protection [213](#)
- DSCP Mapping screen [202](#)
- duplex mode [33, 78, 126, 127](#)
- dust plug
  - transceiver [34](#)
- Dynamic Host Configuration Protocol (DHCP) [74](#)
- dynamic link aggregation [152](#)
- Dynamic MAC Age screen [151](#)
- dynamic router port [103](#)

## E

- earth resistance
  - specification [39](#)
- earthing terminal
  - building [39](#)
- EEE settings
  - VLAN port [144](#)
- Egress Global Burst screen [134](#)
- egress port [83, 142](#)
- EIA rack [28](#)
- EIA standard size [28](#)
- electrical inspection authority [40](#)
- electrical regulation [39](#)
- electrician [40](#)
- electrocution
  - protect from [38](#)
- electrostatic discharge (ESD) [34](#)
- encryption protocol
  - display [227](#)
- endpoint [195](#)
- Energy-Efficient Ethernet (EEE) setting [127](#)
- Error Disable screen [118, 231](#)
- ESD preventive wrist strap [34](#)
- ESD protection [39](#)
- Ethernet port [33](#)
  - default setting [33](#)
  - loop-back test [245](#)

**F**

factory-default configuration file  
  reload [43](#)

FCC interference statement [258](#)

fiber-optic cable [33](#)  
  connecting [35](#)  
  removal [35](#)

File Management screen [243](#)

Filtering MAC screen [150](#)

FINish (FIN) packet [215](#)

Firefox [50](#)

firmware  
  current version [62](#)

firmware update [238](#)

firmware upgrade  
  steps [238](#)

flash (permanent) memory [222](#)

flash partition number [240](#)

flow control  
  state [126](#)

forbidden router port [103](#), [172](#), [173](#)

frame broadcast domain  
  share [23](#)

front panel [31](#)

FTP [24](#)

full duplex [33](#)

**G**

gap  
  screw insertion [27](#)

gateway [75](#)

Getting Start icon [61](#)

Getting Start screen [61](#)

Getting Started screen [51](#)

gigabit Ethernet [22](#)

Gigabit Ethernet (GbE) [17](#)

Global screen [143](#), [235](#)  
  voice VLAN [145](#)

Google Chrome [50](#)

ground cable  
  specification [39](#)

ground wire [38](#)

grounding  
  safety measure [38](#)

grounding bar [39](#)

grounding electrode [39](#)

grounding screw [38](#)

grounding terminal [39](#)

guest VLAN [89](#)

guest VLAN example [143](#)

guest voice media [195](#)

**H**

half duplex [33](#)

hardware installation [25](#)

hardware overview [31](#)

host server  
  IPv4 address [246](#)  
  IPv6 address [247](#)

HTML5 support [50](#)

HTTP [23](#)

HTTP mode [232](#)

HTTP screen [231](#)

HTTPS certificate [233](#)

HTTPS screen [232](#)

**I**

ICMPv6 [23](#)

IEEE 802.1D  
  Spanning Tree Protocol [177](#)

IEEE 802.1D priority level [195](#)

IEEE 802.1Q-2003 [194](#), [195](#)

IEEE 802.1s  
  Multiple Spanning Tree Protocol [177](#)

IEEE 802.1w  
  Rapid Spanning Tree Protocol [177](#)

IEEE 802.3af PoE [81](#), [129](#)

IEEE 802.3at High PoE [81](#), [129](#)

IGMP (Internet Group Management Protocol) [100](#),  
  [169](#)

IGMP Edit screen [171](#)

- IGMP Group screen [102](#)
  - IGMP Port Throttling screen [174, 176](#)
  - IGMP Profile screen [173, 174](#)
  - IGMP Querier version [171](#)
  - IGMP Router Edit screen [172](#)
  - IGMP Router screen [103](#)
  - IGMP screen [100](#)
  - IGMP state [171](#)
  - IGMP Statistics screen [101](#)
  - IGMP VLAN screen [170](#)
  - Image Select screen [240](#)
  - ingress filter [88](#)
  - ingress filtering [141](#)
  - ingress port [83, 195](#)
  - installation
    - air circulation [25](#)
    - desktop [26](#)
    - freestanding [26](#)
    - precautions [29](#)
  - installation requirement
    - rack mounting [28](#)
    - wall mounting [27](#)
  - installation scenarios [25](#)
  - Internet Control Message Protocol (ICMP) [215](#)
  - Internet Explorer [50](#)
  - Internet Protocol version 6, see IPv6
  - introduction [17](#)
  - IP address [121](#)
    - default [74, 120](#)
    - TFTP server [238](#)
  - IP Precedence Mapping screen [203](#)
  - IP Telephony handset [195](#)
  - IPv4 address
    - host server [246](#)
  - IPv4 Address screen [120](#)
  - IPv4 information [74](#)
  - IPv4 ping test [245](#)
  - IPv4 unknown multicast frame [170](#)
  - IPv4/IPv6 dual stack [23](#)
  - IPv6 [23](#)
    - Neighbor Discovery Protocol [23](#)
    - ping [23](#)
  - IPv6 address [121](#)
    - host server [247](#)
  - IPv6 Address screen [121](#)
  - IPv6 information [75](#)
  - IPv6 ping test [247](#)
  - IPv6 Ping Test screen [247](#)
  - ISO 3166
    - country code [193](#)
- ## J
- Java
    - permissions [50](#)
  - JavaScripts [50](#)
- ## L
- LACP Port screen [156, 157](#)
  - LAG Management screen [153, 154](#)
  - LAG Port screen [155](#)
  - LAG port settings
    - view [155](#)
  - latitude [192](#)
  - LED
    - Link/ACT [36](#)
    - PoE [36](#)
    - SYS [43](#)
  - LED description [41](#)
  - LEDs [41](#)
  - link aggregation (trunking) [95, 152](#)
  - Link Aggregation Control Protocol (LACP) [153](#)
  - Link Aggregation screen [95](#)
  - link aggregation setting [70](#)
  - Link Layer Discovery Protocol (LLDP) [110](#)
  - Link Layer Discovery Protocol (LLDP) screens [186](#)
  - link status [78](#)
  - Link/ACT LED [36](#)
  - LLDP global statistics [110](#)
  - LLDP Port screen [188](#)
  - LLDP port settings
    - inspect and configure [186](#)
  - LLDP port statistics [110](#)
  - LLDP screen [110](#)
  - LLDP Switch settings
    - configure [186](#)

Local Information screen [189](#)  
 Local screen [221](#)  
 location coordinates [192](#)  
 Login screen [50](#)  
 logout  
   Web Configurator [53](#)  
 longitude [193](#)  
 loop guard [97, 158](#)  
   how it works [97](#)  
   probe packet [97, 98](#)  
 Loop Guard screen [98](#)  
 loop state [97](#)  
 loop-back test  
   on Ethernet port [245](#)

## M

M4 ground screw [39](#)  
 MAC address [93, 116, 149](#)  
   range [62](#)  
 MAC table flowchart [92](#)  
 MAC Table screen [92](#)  
 Maintenance menu  
   Web Configurator [60](#)  
 manage the Switch  
   good habits [24](#)  
   methods [23](#)  
 Management Access List screen [236](#)  
 management VLAN [75, 121](#)  
 managing the device  
   using FTP, see FTP  
   using SNMP, see SNMP  
   using the Web Configurator, see Web Configurator  
 Mbuf (Memory Buffer) [241](#)  
 MD5 authentication protocol [227](#)  
 Mean Lower Low Water (MLLW) [193](#)  
 MED Port Location screen [191](#)  
 MED Port screen [196](#)  
 memory buffer [222](#)  
 memory usage [62](#)  
 Microsoft Edge [50](#)  
 mini GBIC port [33](#)  
   connector type [33](#)  
   transceiver installation [34](#)  
   transceiver removal [35](#)  
 mini GBIC ports  
   connection speed [34](#)  
 mirror  
   outgoing traffic [162](#)  
 Mirror screen [161](#)  
 model name [62](#)  
 models  
   Switch [19](#)  
 Monitor menu  
   Web Configurator [54](#)  
 mounting bracket [28](#)  
   attach [29](#)  
 MSA (MultiSource Agreement) [33](#)  
 MST Instance screen [106, 182, 183](#)  
 MST Port screen [107, 184](#)  
 MSTP [104](#)  
 MSTP (Multiple Spanning Tree Protocol) [104](#)  
 MTU (Multi-Tenant Unit) [86, 138](#)  
 multicast [169](#)  
   in monitor [100](#)  
 multicast packet [136](#)  
 Multiple Spanning Tree Instance (MSTI) [107, 182, 183](#)  
 Multiple Spanning Tree Protocol (MSTP) [109, 177](#)  
 Multiple Spanning Tree Protocol, see MSTP [104](#)

## N

Neighbor Discovery Protocol [23](#)  
 network application [20](#)  
 network bottleneck  
   eliminate [21](#)  
 network connectivity device [195](#)  
 network element (NE) [224](#)  
 network management system (NMS) [224](#)  
 Network Policy Configuration screen [194](#)  
 New Network Policy screen [194](#)  
 NTP (Network Time Protocol) [63, 65](#)

## O

one-time schedule [164, 165](#)

OUI address [146](#)

OUI screen [146](#)

overheating  
prevention [25](#)

## P

partition image size [240](#)

password  
administrator [51](#)  
change [24](#)

path cost [178](#)

PD power classification [130](#)

PD priority [130](#), [132](#)

periodic time range rule  
modify [166](#)

ping  
IPv4 server [245](#)  
IPv6 server [247](#)

Ping of Death [213](#)

ping test  
steps [246](#), [247](#)

Ping Test screen [246](#)

PoE  
power management mode [129](#)

PoE (Power over Ethernet) [20](#)

PoE Global screen [129](#)

PoE LED [36](#)

PoE mode [82](#)

PoE MODE button [36](#)

PoE Port screen [129](#), [131](#)

pop-up windows [50](#)

port  
name [126](#)  
priority [157](#)  
status [128](#)  
VLAN ID [141](#)

port counters setting [78](#)

Port Isolation screen [209](#)

port mirroring [161](#)

port name [78](#)

Port Overloading screen [112](#)

Port Rate screen [135](#)

Port screen [87](#), [125](#), [140](#)

guest VLAN [144](#)

Port screens [77](#)

Port Security screen [114](#), [209](#)

port statistics  
view [77](#)

Port Status screen [116](#)

port test  
steps [245](#)

power connection [40](#)

power module  
disconnecting [41](#)

POWER ON/OFF switch [40](#)

Power over Ethernet (PoE) standards [129](#)

Power Sourcing Equipment (PSE) [81](#), [129](#)

Powered Device (PD) [20](#), [82](#), [129](#)

privacy password [228](#)

privilege level  
of user [234](#)

protocol based VLAN [91](#)  
and IEEE 802.1Q tagging [91](#)  
isolate traffic [91](#)

PVID (Port VLAN ID) [87](#)

## Q

QoS (Quality of Service) [68](#), [198](#)

QoS Port screen [198](#), [204](#)

QoS Queue screen [200](#)

QoS setting [68](#)

## R

rack mounting [28](#)  
installation requirements [28](#)  
steps [29](#)

RADIUS Servers screen [217](#)

Rapid Spanning Tree Protocol (RSTP) [177](#)

Rapid Spanning Tree Protocol, see RSTP [104](#)

rear panel [36](#)

Reboot System screen [249](#)

reboot the Switch [249](#)

rebooting [44](#)

- recurring schedule [164, 165](#)
  - Remote Device screen [111](#)
  - remote management
    - using PING [23](#)
  - reset
    - to original settings [244](#)
  - RESET button [43](#)
  - reset the Switch [43](#)
  - reset to factory defaults
    - steps [244](#)
  - restart the Switch
    - steps [249](#)
  - RESTORE button [43](#)
  - restore configuration
    - from a file on a server [243](#)
    - from a file on your computer [243](#)
  - Restore Factory Default screen [244](#)
  - restoring configuration [44](#)
  - revision number
    - Switch [62](#)
  - Router Port screen [172](#)
  - RSTP [104](#)
  - RSTP (Rapid Spanning Tree Protocol) [108](#)
  - rubber feet
    - attach [26](#)
- ## S
- safety precautions [25](#)
  - Scan attack [213](#)
  - schedule
    - one-time [164](#)
    - recurring [164](#)
    - type [165, 167](#)
  - screen resolution [50](#)
  - screw anchor [26](#)
  - screw specification
    - wall mounting [27](#)
  - security vulnerability
    - fixes [238](#)
  - serial number [62](#)
  - server bottleneck
    - eliminate [21](#)
  - service personnel
    - grounding [39](#)
  - session timeout [232](#)
    - value [233](#)
  - SHA authentication protocol [227](#)
  - shared server
    - VLAN example [23](#)
  - Simple Network Management Protocol (SNMP) [224](#)
  - Small Form-Factor Pluggable (SFP) transceiver [33](#)
  - SNMP [23, 24](#)
    - SNMP community
      - access right [52](#)
    - SNMP trap
      - version supported [230](#)
  - SNMP Trap Host screen [229](#)
  - SNMP Trap screen [229](#)
  - SNMP User screen [227](#)
  - SNMP version [224](#)
  - SNMPv3 Group screen [225](#)
  - snooping state
    - IGMP packet [169](#)
  - snooping version [169](#)
  - SNTP
    - enable [122](#)
  - SNTP (Simple Network Time Protocol) [122](#)
  - SNTP Server screen [123](#)
  - softphone application [195](#)
  - Spanning Tree Protocol (STP) [158, 177](#)
  - Spanning Tree Protocol, see STP [104](#)
  - spanning tree STP statistics
    - view [108](#)
  - speed
    - of Ethernet connection [127](#)
  - SSH (Secure SHell protocol) [234](#)
  - SSH screen [233](#)
  - startup configuration file
    - overwrite [244](#)
  - stateless auto-configuration [23](#)
  - static address assignment [23](#)
  - static link aggregation [152](#)
  - Static MAC screen [149](#)
  - static router port [103, 172, 173](#)
  - static VLAN ID [173](#)
  - Statistics screen [110](#)
  - status

LED [41](#)  
   view [61](#)  
 Storm Control Port screen [136](#)  
 Storm Control screen [84, 136](#)  
 STP [104, 108](#)  
 STP CIST Port screen [182](#)  
 STP Port screen [178](#)  
 straight-through Ethernet cable [33](#)  
 subnet mask [75, 121](#)  
   default [74, 120](#)  
 supported browsers [50](#)  
 surge protection [39](#)  
 Switch  
   fanless-type usage precaution [25](#)  
   fan-type usage precaution [25](#)  
 switch reboot [44](#)  
 SYNchronization (SYN) [215](#)  
 SYS LED [43](#)  
 syslog (system logging) [221](#)  
 Syslog screen [117](#)  
 syslog server [221](#)  
 syslog server information  
   display [223](#)  
 system  
   contact [123](#)  
   location [123](#)  
   name [123](#)  
 system date and time [122](#)  
 system information  
   view [75](#)  
 System Information screen [123](#)  
 system name [62](#)  
 System screens [74](#)  
 System Time screen [122](#)  
 system uptime [62](#)

## T

TACACS+ screen [219](#)  
 TACACS+ Servers screen [219](#)  
 technical support [241](#)  
 technician  
   attach the Switch [25](#)

telnet [23](#)  
 TELNET screen [233](#)  
 TFTP [23](#)  
 TFTP server  
   IP address [238](#)  
 time range [133, 164](#)  
 Time Range Group screen [164, 165](#)  
 time zone [122](#)  
 timer [157](#)  
 trace route  
   steps [248](#)  
 Trace Route screen [248](#)  
 trademarks [264](#)  
 transceiver [33](#)  
   installation [34](#)  
   removal [35](#)  
 Trap Destination screen [230](#)  
 trunk  
   active member [154](#)  
   standby member [154](#)

## U

UDP port [230](#)  
 unicast [100, 169](#)  
 unicast packet [136](#)  
 Upload screen [238](#)  
 users  
   currently logged in [62](#)  
 Users screen [234](#)

## V

ventilation holes [25](#)  
   warning [26](#)  
 video conferencing equipment [195](#)  
 VLAN  
   create [66](#)  
   tag-based [23](#)  
 VLAN (Virtual Local Area Network) [22, 86, 138](#)  
 VLAN group [149](#)  
   membership [142](#)



- VLAN ID [66](#), [100](#), [103](#)
- VLAN ID (VID) [194](#)
- VLAN ID number [139](#)
- VLAN name [139](#)
- VLAN Port screen [88](#), [142](#)
- VLAN screen [86](#), [139](#)
- VLAN setting [66](#)
- VLAN trunking [141](#)
  - on ports [88](#)
- VLAN, protocol based, see protocol based VLAN
- voice quality [90](#)
- voice traffic [90](#)
- voice VLAN [90](#), [145](#)
- voice VLAN ID [146](#)
- voice VLAN port
  - security mode state [148](#)
- supported firmware version [46](#)
- Zyxel AP Configurator [49](#)
- Zyxel Discovery Protocol (ZDP) [45](#)
- Zyxel One Network (ZON) [45](#)

## W

- wall mounting [26](#)
  - installation requirements [27](#)
- warranty [264](#)
  - note [264](#)
- Web Configurator [24](#)
  - access [50](#)
  - logout [53](#)
  - navigate [52](#)
  - password [51](#)
  - requirements [50](#)
  - supported browsers [50](#)
  - warning [51](#)
- wiring closet [28](#)
- World Geodesic System (WGS) [193](#)

## Z

- ZON Utility
  - icon [48](#)
- ZON utility [24](#), [45](#)
  - hardware requirements [45](#)
  - installation requirements [45](#)
  - run [46](#)
  - supported devices [46](#)