

ZYXEL

Your Networking Ally

User's Guide

PLA5000 Series

Powerline Ethernet Adapters

Default Login Details

Default Network Name	HomePlugAV
----------------------	------------

Utility Version 7.0.2 Ed. 9, 10/2018

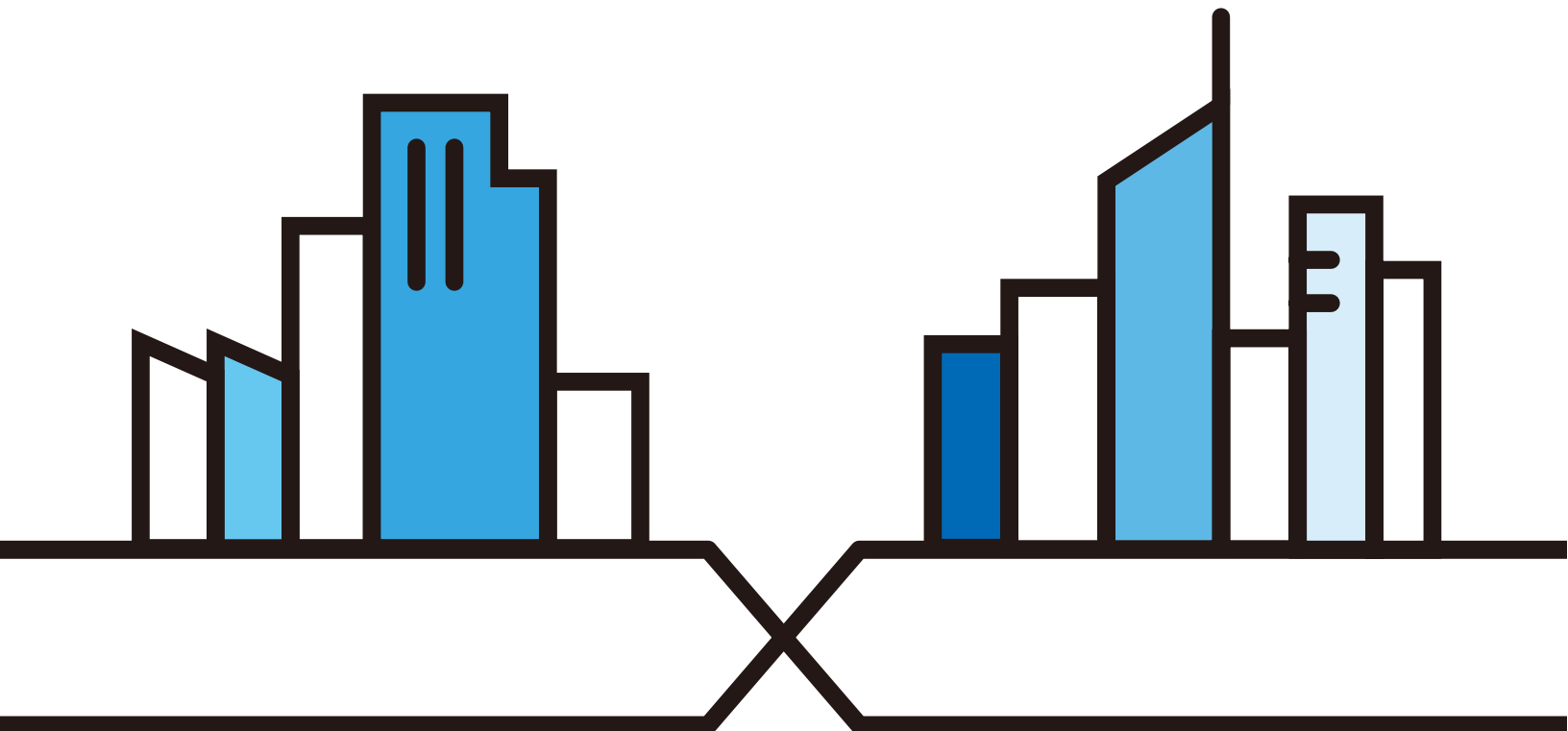

IMPORTANT!

READ CAREFULLY BEFORE USE.

KEEP THIS GUIDE FOR FUTURE REFERENCE.

This is a User's Guide for a series of products. Not all products support all features. Screenshots and graphics in this book may differ slightly from what you see due to differences in release versions or your computer operating system. Every effort has been made to ensure that the information in this manual is accurate.

Related Documentation

- Quick Start Guide

The Quick Start Guide shows how to connect and set up the PLA in your network.

- More Information

Go to support.zyxel.com to find other information on the PLA.



Table of Contents

Table of Contents	3
Part I: User's Guide	5
Chapter 1	
Introducing the PLA	6
1.1 Overview	6
1.2 LEDs	7
1.3 Standby Mode (Power Saving Mode)	8
1.4 Ways to Manage the PLA	8
1.5 Expand Your Network with the PLA	8
1.6 Security	9
1.6.1 Passwords	9
1.6.2 Setting Up Security	9
1.7 Multiple Networks	10
Chapter 2	
The RESET/ENCRYPT Button	12
2.1 RESET/ENCRYPT Button Overview	12
2.2 Adding Devices to a Powerline Network	12
2.3 Removing a Device from a Powerline Network	14
2.4 Multiple Separate Powerline Networks	15
2.5 PLAs With One Combination RESET/ENCRYPT Button	15
2.6 PLAs with Separate RESET and ENCRYPT Buttons	16
2.6.1 ENCRYPT Button Behavior	16
2.6.2 RESET Button Behavior	17
Part II: Technical Reference	18
Chapter 3	
Installing the Utility	19
3.1 Windows	19
3.1.1 System Requirements	19
3.1.2 Installing the Utility	19

Chapter 4	
The Configuration Utility	26
4.1 Overview	26
4.1.1 Powerline Network Security	26
4.1.2 Device Access Key (DAK)	27
4.2 Starting the Configuration Utility	27
4.3 Network Info Screen	27
4.3.1 Icon View	27
4.3.2 List View	29
4.4 Configuration Screen	30
4.5 Advanced Screen	31
4.6 About Screen	34
Chapter 5	
Powerline Network Setup Tutorial	36
5.1 Overview	36
5.2 Important Terms	36
5.3 Accessing Your Powerline Adapter	37
5.4 Adding a Powerline Adapter	37
5.5 Setting Up a New Network with a New Adapter	39
5.6 Splitting a Network into Two Networks	41
5.7 Troubleshooting	43
Chapter 6	
Troubleshooting	44
6.1 Power and Light Problems	44
6.2 Configuration Utility Problems	45
6.3 Powerline Problems	46
6.4 RESET/ENCRYPT Button Problems	46
Appendix A Customer Support	48
Appendix B Legal Information	54
Index	60

PART I

User's Guide

CHAPTER 1

Introducing the PLA

1.1 Overview

This chapter introduces the main applications and features of your Zyxel HomePlug AV compliant Powerline adapter, which is called "PLA" in this guide. The following generic icon is used to represent all PLA models.



In this User's Guide the electrical wiring network is referred to as the "Powerline network". The HomePlug AV standard specifies how network devices communicate using standard electrical wiring.

This User's Guide covers the following models:

Table 1 PLA Comparison Table 1: 600 ~ 1,000 Mbps Models

PORT/FEATURE	PLA5205	PLA5215	PLA5206	PLA5256	PLA5206 v2
Gigabit Ethernet port(s)	1	1	1	2	2
AC Pass-Through		✓		✓	
Reset/Encrypt Button			✓	✓	✓
Reset Button	✓	✓			
Encrypt Button	✓	✓			
Maximum PHY Rate over Powerline	600 Mbps	600 Mbps	1000 Mbps	1000 Mbps	1000 Mbps

Table 2 PLA Comparison Table 2: 1,200 ~ 1,800 Mbps Models

PORT/FEATURE	PLA5405	PLA5405V2	PLA5456
Gigabit Ethernet port(s)	1	1	2
AC Pass-Through			✓
Reset/Encrypt Button	✓		✓
Reset Button		✓	
Encrypt Button		✓	
Maximum PHY Rate over Powerline	1200 Mbps	1300 Mbps	1800 Mbps

Note: In this guide **RESET/ENCRYPT** also refers to the **ENCRYPT** button in PLAs that have separate **RESET** and **ENCRYPT** buttons.

You can directly plug an electrical device (such as a router or computer) into PLAs with an AC power pass-through socket to supply power to the device.

The power plug varies depending on your region.

1.2 LEDs

The following sections describes the lights on the PLA.

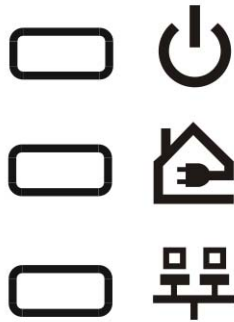

The following figure is the front panel of the PLA. Use the lights to determine if the PLA is behaving normally or if there are some problems on your Powerline network.

Figure 1 PLA Lights



The following table describes the behavior of the lights on the PLA.

Table 3 LEDs: 600 / 1000 / 1200 / 1300 / 1800 Mbps Models

LIGHTS	ICON	COLOR	STATUS	DESCRIPTION
POWER		Green	On	The PLA is on and receiving power. It also indicates a successful connection using the RESET/ ENCRYPT button.
			Blinking	It indicates the PLA is trying to connect with another device using the ENCRYPT function. The Power LED blinks when it is in standby mode. Refer to Section 1.3 on page 8 for details on this feature.
			Off	The PLA is not receiving power.
HomePlug		Green	On	The PLA detects another Powerline adapter. The data transfer rate is greater than 80 Mbps.
		Amber		The PLA detects another Powerline adapter. The data transfer rate is between 20~80 Mbps.
		Red		The PLA detects another Powerline adapter. The data transfer rate is between 0~20 Mbps.
		Green/ Amber/ Red	Blinking	The PLA is communicating with another Powerline adapter. Data is being transmitted and/or received.
			Off	The HomePlug port does not detect another Powerline adapter.
ETHERNET		Green	On	The Ethernet connection is up.
			Blinking	The PLA is communicating with a networking device connected to it.
			Off	The PLA does not detect any devices connected to its ETHERNET port.

1.3 Standby Mode (Power Saving Mode)

Your PLA is a certified green product. It goes into standby mode when there is no Ethernet connection.

When you plug the PLA into an electric socket, it waits for an Ethernet connection. When no connection is detected after three minutes, the Power LED blinks indicating that it is going into standby mode.

The same process occurs when you disconnect the PLA from a previously working Ethernet connection. Three minutes after disconnecting the Ethernet cable, the PLA's power LED blinks signaling that it is going into standby mode.

The Ethernet and HomePlug LEDs are turned off in standby mode.

While in standby mode, you cannot use the **RESET/ENCRYPT** button. To enable the **RESET/ENCRYPT** button again, you have to connect the PLA's Ethernet cable to a computer/notebook or modem/router first. The PLA wakes up from standby mode and you can start using the **RESET/ENCRYPT** button.

1.4 Ways to Manage the PLA

Use the **RESET/ENCRYPT** button to add Powerline devices to your Powerline network if they have this button. See [Chapter 2 on page 12](#) for instructions on using the ENCRYPT feature.

Use the **Zyxel PLA Series Configuration** utility (or utility, for short) to manage the PLA. See [Chapter 3 on page 19](#) for instructions on installing the utility.

1.5 Expand Your Network with the PLA

The PLA plugs into an ordinary power outlet to easily extend a cable or DSL broadband connection or existing Ethernet (LAN) network to any other electrical outlet in any room of a house, all without the need for any new cabling. Devices can securely communicate with each other at high data transfer rates. The PLA uses 128-bit Advanced Encryption Standard (AES) to ensure safe transfer of information.

Figure 2 Expand Your Network with the PLA

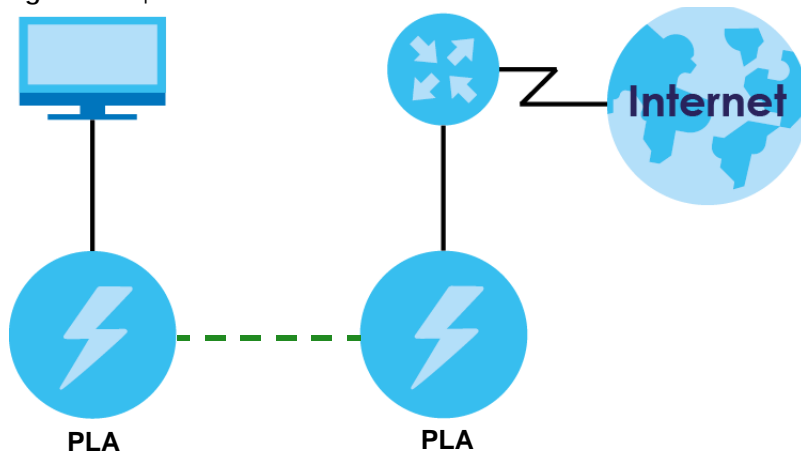

Connect your PLA to an Internet gateway such as a modem and plug it into an ordinary power outlet in your home. Plug a second PLA into another power outlet and connect a computer to the PLA for Internet access. Your network can be further expanded by plugging additional PLAs into other outlets in your home and connecting other computers or network devices (for example, a printer) to them.

Refer to your Quick Start Guide for hardware connection information.

1.6 Security

Since your Powerline network may extend outside your premises, it is important to set up security on your PLA.

1.6.1 Passwords

You use two types of passwords in the HomePlug AV Powerline network. The following table describes the differences between the passwords.

Table 4 Password Summary

PASSWORD	DESCRIPTION
Network Name	All Powerline adapters that follow the HomePlug AV standard are shipped with the same Powerline network name "HomePlugAV". Change the network name via the Zyxel PLA Series Configuration utility or RESET/ENCRYPT button to create a private network. See Section 4.4 on page 30 .
DAK (Data Access Key) Password	In order to manage the Powerline adapters on your Powerline network you must enter the adapters' DAK password in the Zyxel PLA Series Configuration utility. This password is printed on the Powerline adapter itself. You don't need to add the password for the Powerline adapter directly connected to the computer running the configuration utility (local Powerline adapter), you only have to add the remote Powerline adapters' passwords (those on your circuit, but not directly connected to your computer).

1.6.2 Setting Up Security

The ENCRYPT feature automatically sets up security on your Powerline network. Use this feature if your Powerline devices have the **RESET/ENCRYPT** button.

Alternatively, use the **Zyxel PLA Series Configuration** utility to set up security on the PLA. Although the PLA is a "plug-and-play" network expanding solution there are several reasons for enabling security on the Powerline network in your home.

- 1 It's easy and only requires you to change a network name.

- 2 It's a good idea to ensure privacy of your communication. When you use the PLA and other Powerline adapters, the electrical wiring in your home becomes an extension of your Ethernet network. Your network traffic flows freely within the electrical circuit of your home and is bounded in most cases by a power meter.

Without security (encryption) your information is accessible to anyone using a Powerline adapter on the same electrical circuit. In some cases, a circuit can be shared by more than one household.

To prevent compromising your network security, you can create a private network. A private network uses a secret password (**Network Name**) to make sure that only permitted Powerline adapters can communicate in your network. See [Section 4.4 on page 30](#) for information on setting up a private network.

- 3 You may need to change the **Network Name** to create multiple Powerline networks. See the next section for more information on how to set up a multiple network.

1.7 Multiple Networks

Multiple Powerline networks can coexist on a single Powerline circuit. You might want to implement multiple Powerline networks in a small office environment where you have two separate Ethernet networks.

- 1 Connect one Powerline adapter to a router or switch on the first Ethernet network and assign a **Network Name** (for example "Password1") to this Powerline adapter. Add additional Powerline adapters to your network by plugging them into your Powerline outlets and assigning them "Password1". This completes the configuration of your first Powerline network.
- 2 Connect another Powerline adapter to a router or switch on the second Ethernet network and assign a different **Network Name** (for example "Password2") to this Powerline adapter. Again, add additional Powerline adapters and assign them "Password2".

You now have two private networks on your Powerline circuit. Information is not shared between the two networks as only Powerline adapters with the same **Network Name** can communicate with each other.

CHAPTER 2

The RESET/ENCRYPT Button

Use the **RESET/ENCRYPT** button to automatically set up a secure Powerline connection between your Powerline devices.

Note: In this guide **RESET/ENCRYPT** also refers to the **ENCRYPT** button in PLAs that have separate **RESET** and **ENCRYPT** buttons.

2.1 RESET/ENCRYPT Button Overview

The **RESET/ENCRYPT** button allows you to set up a secure Powerline connection with other HomePlug AV compliant Powerline devices which also support the **ENCRYPT** feature. No other Powerline setting changes are required to connect.

You can use the **RESET/ENCRYPT** button to:

- set up a new Powerline network.
- separate an existing Powerline network into multiple networks.
- reset the PLA to the factory defaults.

2.2 Adding Devices to a Powerline Network

You can connect a number of PLAs on a Powerline network, but you can use the **RESET/ENCRYPT** button on only two PLAs at a time.

Place a Powerline device close to another Powerline device so you have time to set up each one. After you set up the first Powerline device, you have 120 seconds to set up the second Powerline device.

Note: Your PLA must be connected to a networking equipment for the **RESET/ENCRYPT** button to work. Refer to [Section 1.3 on page 8](#) for more details.

Follow the steps below to set up your HomePlug AV Network:

- 1 Press the **RESET/ENCRYPT** button at the side of your Powerline device for 0.5 to 3 seconds. The power (⏻) light will blink as the Powerline device tries to set up a connection with a new random network name.

Figure 3 ENCRYPT Connection Procedure

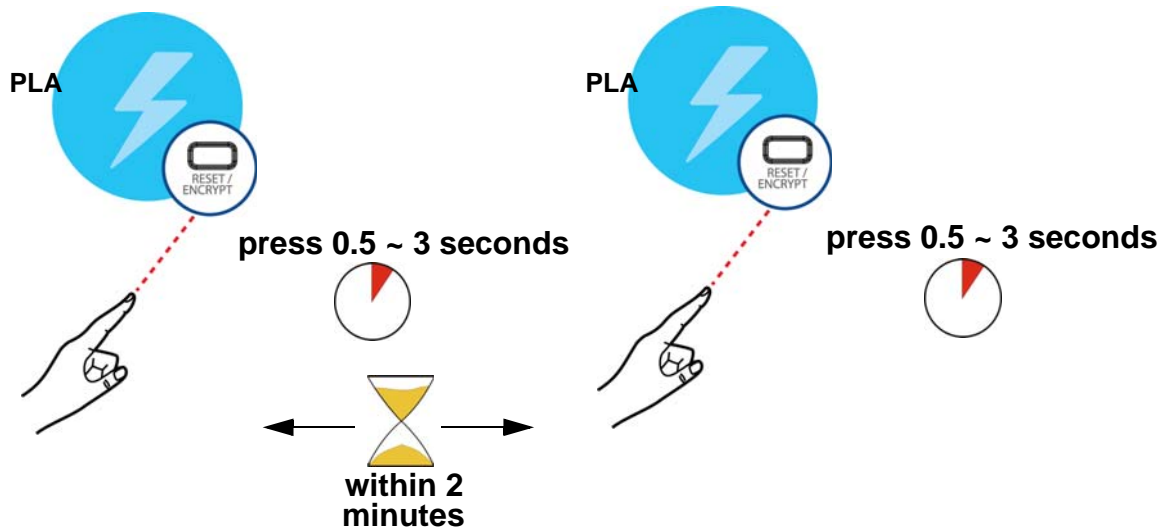

Note: The **RESET/ENCRYPT** button's location varies for each Powerline model.

Note: Check the lights on the two Powerline devices. The power (🔌) and HomePlug (🏠) lights should be on while the devices are connecting. Wait for about two minutes while your Powerline devices connect.

If the power (🔌) light does not blink when you press **RESET/ENCRYPT**, you have probably pressed the **RESET/ENCRYPT** button for too long. Try again, pressing the **RESET/ENCRYPT** button for 0.5 to 3 seconds.

If the HomePlug (🏠) lights on both Powerline devices do not light up, the Powerline devices are not connected. Repeat step 1 in this section. If that doesn't work, see the Troubleshooting in Section 6.4 on page 46 for suggestions.

- 2 To add more Powerline devices to your network, use any Powerline device (**A** or **B**) you have connected to set up a connection with the Powerline devices you want to connect (**C** and **D**).
- 3 Press the **RESET/ENCRYPT** button on both Powerline devices (**A** and **C**, or **B** and **C**) for 0.5 to 3 seconds to add Powerline device **C**. This must be done within 2 minutes (120 seconds) of pressing the **RESET/ENCRYPT** button on the PLA.
- 4 Press the **RESET/ENCRYPT** button on both Powerline devices (**A** and **D**, **B** and **D** or **C** and **D**) for 0.5 to 3 seconds to add Powerline device **D**. This must be done within 2 minutes (120 seconds) of pressing the **RESET/ENCRYPT** button on the PLA.

Figure 4 Adding More Powerline Adapters to Your Network

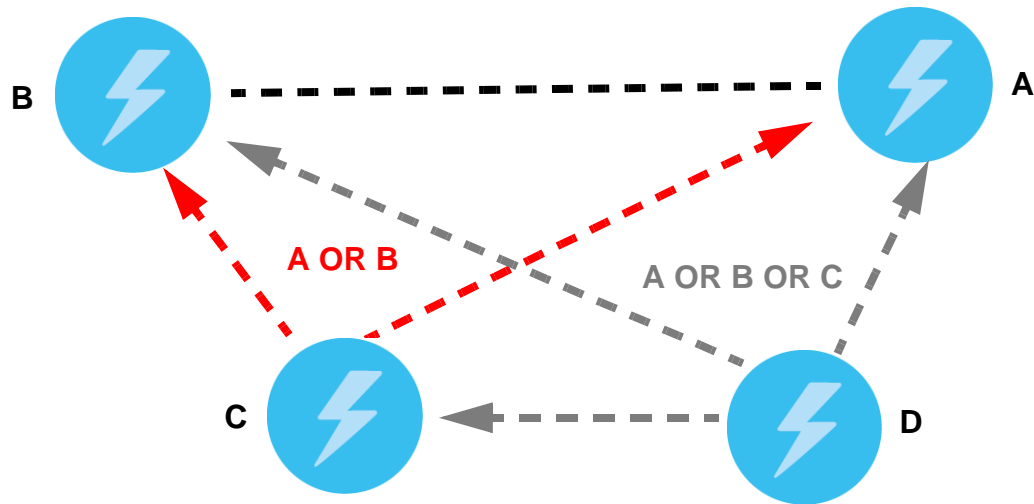

This sets up your Powerline network between your Powerline devices.

2.3 Removing a Device from a Powerline Network

Suppose you want to remove PLAs (C) and (D) from the following Powerline network.

Figure 5 Removing Devices From an Existing Powerline Network

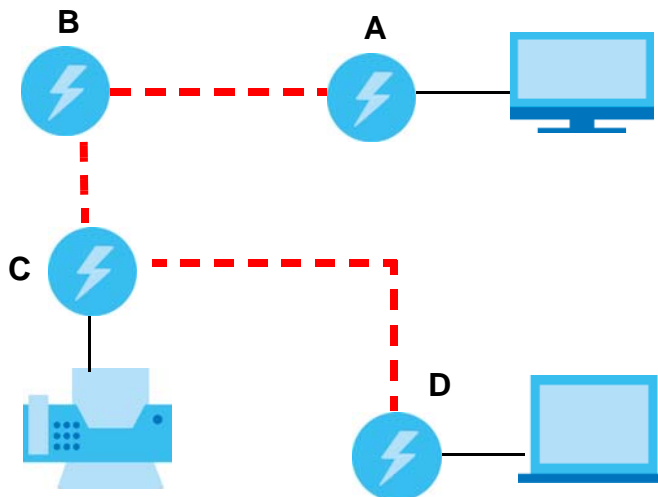

- 1 Press the **RESET/ENCRYPT** button on Powerline device C for 5 to 8 seconds and then release it. This disconnects C from the current network.
- 2 Press the **RESET/ENCRYPT** button on Powerline device D for 5 to 8 seconds and then release it. This disconnects D from the current network.

Note: If C or D are models with a separate **ENCRYPT** button, press the button for more than 10 seconds and then release it.

2.4 Multiple Separate Powerline Networks

You can use the **RESET/ENCRYPT** button to create multiple separate Powerline networks. Use the **RESET/ENCRYPT** button on only two PLAs at a time.

- 1 Press the **RESET/ENCRYPT** button on Powerline devices **E** and **F** for 0.5 to 3 seconds. This must be done within 2 minutes (120 seconds) of pressing the **RESET/ENCRYPT** button on the first PLA.
- 2 Wait for about one minute while Powerline devices **E** and **F** connect.
- 3 Now pair two different PLAs. Press the **RESET/ENCRYPT** button on Powerline devices **G** and **H** for 0.5 to 3 seconds and within two minutes of each other.
- 4 Wait for about one minute while Powerline devices **G** and **H** connect.
- 5 When the power (🔌) and HomePlug (🏠) lights shine steadily, the devices are connected.

Figure 6 Two Separate Powerline Networks

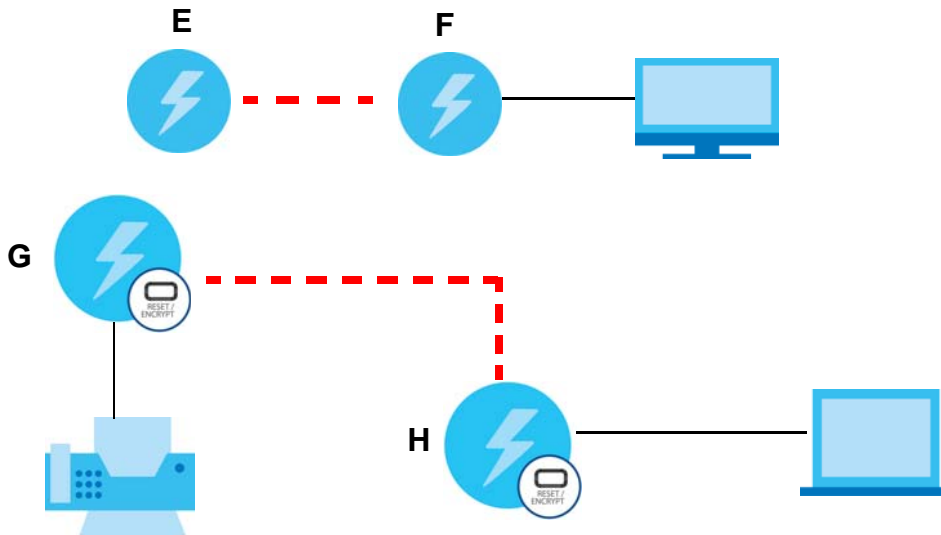







If the HomePlug (🏠) lights on both Powerline devices do not light up, the Powerline devices are not connected. Repeat the connection process, making certain you press the **RESET/ENCRYPT** buttons for the correct time and within two minutes of each other. If that does not work see Section 6.4 on page 46 for suggestions.

2.5 PLAs With One Combination RESET/ENCRYPT Button

Refer to [Table 1 on page 6](#) to see which models have a combination **RESET/ENCRYPT** button.

The following table summarizes the actions that occur when the **RESET/ENCRYPT** button is pressed for specific lengths of time.

Table 5 **RESET/ENCRYPT**

TIME	ACTION	POWER LIGHT BEHAVIOR	HOMEPLUG LIGHT BEHAVIOR
0.5 to 3 seconds	Create a Powerline network with a new random network name. Join an existing Powerline network by sharing the same network name as other devices on the network.	The power () light blinks until the device is connected. This may take a minute.	The HomePlug () light turns on if your device is connected to another Powerline device or a Powerline network.
5 to 8 seconds	Remove the device from any network it is associated with and its network name assumes a random value.	The power () light blinks and then shines steadily.	The HomePlug () light turns off when it disconnects from the Powerline network.
10 to 15 seconds	Clear all user-entered configuration information and return the device to its factory defaults.	The power () light blinks and then shines steadily.	The HomePlug () light turns off when it disconnects from the Powerline network.

Note: The network name is unknown when you use the **RESET/ENCRYPT** button.





2.6 PLAs with Separate RESET and ENCRYPT Buttons

Refer to [Table 1 on page 6](#) to see which models have separate **RESET** and **ENCRYPT** buttons.

2.6.1 ENCRYPT Button Behavior

The following table summarizes the actions that occur when the **ENCRYPT** button is pressed for specific lengths of time.

Table 6 **ENCRYPT**

TIME	ACTION	POWER LIGHT BEHAVIOR	HOMEPLUG LIGHT BEHAVIOR
less than 3 seconds	Create a Powerline network with a new random network name. Join an existing Powerline network by sharing the same network name as other devices on the network.	The power () light blinks until the device is connected. This may take a minute.	The HomePlug () light turns on if your device is connected to another Powerline device or a Powerline network.
more than 10 seconds	Remove the device from any network it is associated with and its network name assumes a random value.	The power () light blinks and then shines steadily.	The HomePlug () light blinks red one time and then turns off when it disconnects from the Powerline network.

2.6.2 RESET Button Behavior

Use a pointed device such as a pin to reset the **Network Name** back to default **HomePlugAV**.

Table 7 RESET Button

TIME	ACTION	POWER LIGHT BEHAVIOR	HOMEPLUG LIGHT BEHAVIOR
1 to 3 seconds	Clear all user-entered configuration information and return the device to its factory defaults.	The power (🔌) light blinks and then shines steadily.	The HomePlug (🏠) light turns off when it disconnects from the Powerline network.

See Troubleshooting in [Chapter 6 on page 46](#) for suggestions on problems with the **RESET/ENCRYPT** button and the lights.

PART II

Technical Reference

CHAPTER 3

Installing the Utility

This chapter guides you through the installation of the configuration utility for your PLA.

3.1 Windows

This section uses the Windows XP screens as an example to show you how to install the Windows version of the **Zyxel PLA Series Configuration** utility.

3.1.1 System Requirements

At the time of writing, the **Zyxel PLA Series Configuration** utility is compatible with:

- Windows XP (32-bit version)
- Windows XP (64-bit version)
- Windows Vista (32-bit version)
- Windows Vista (64-bit version)
- Windows 7 (32-bit version)
- Windows 7 (64-bit version)
- Windows 8 (32-bit version)
- Windows 8 (64-bit version)

Note: To check for your Windows operating system version, right-click on **My Computer > Properties**. You should see this information in the **General** tab.

Microsoft's .NET Framework version 4 and WinPcap 4.1.3 software are necessary for the installation of the **Zyxel PLA Series Configuration** utility. The utility automatically installs WinPcap 4.1.3 and .NET Framework version 4 on all supported operating systems (if it's not already installed on your computer).

3.1.2 Installing the Utility

Follow the steps below to install WinPcap 4.1.3, .NET Framework version 4 and the **Zyxel PLA Series Configuration** utility on your computer.

- 1 Go to the Zyxel Download Library and download the utility to your computer. Double click the utility **setup.exe** file.

If WinPcap 4.1.3 is already installed on your computer, the following screen appears. Click **Cancel** and go to step 5.

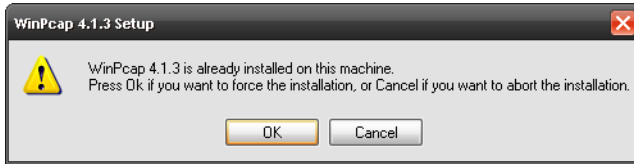

Otherwise, the WinPcap setup wizard runs automatically. Click **Next** to continue.

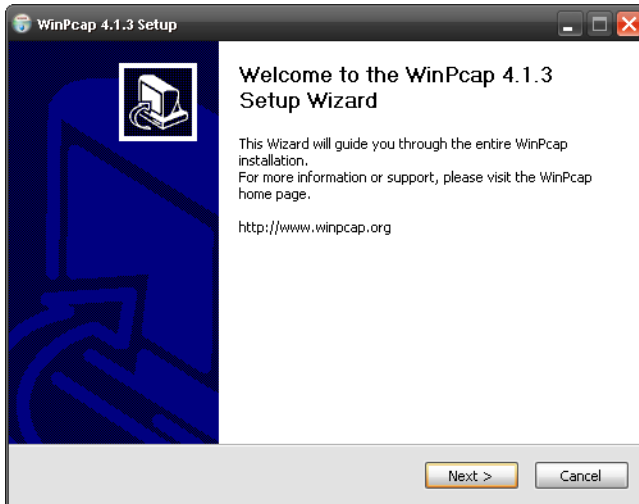

- 2 Review the **license agreement**, and click **I Agree** to proceed.

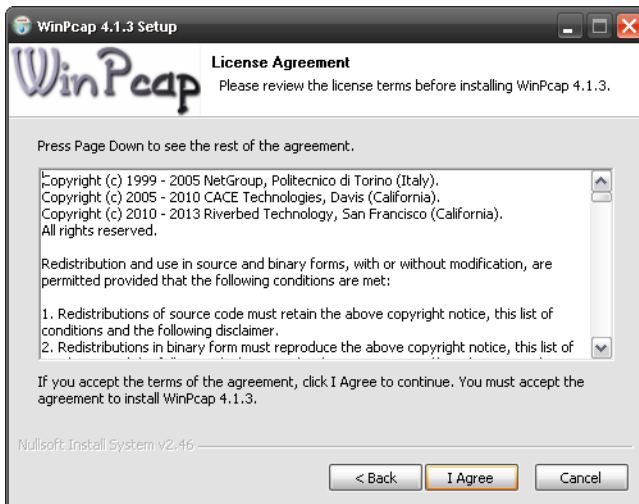

- 3 Select **Automatically start the WinPcap driver at boot time** if you want to start WinPcap automatically when the computer boots. Click **Install** to install WinPcap.

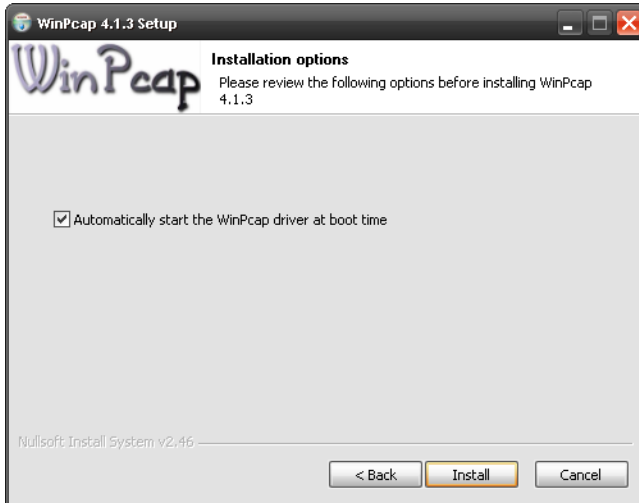

- 4 Select **I want to manually reboot later**, and click **Finish** to exit the wizard.



- 5 A prompt appears asking you to install the .NET Framework version 4. Review Microsoft's **License Agreement**, select **I have read and accept the license terms**, and click **Intall** to proceed.

Note: If you already have .NET Framework version 4 installed on your computer this step can be skipped.

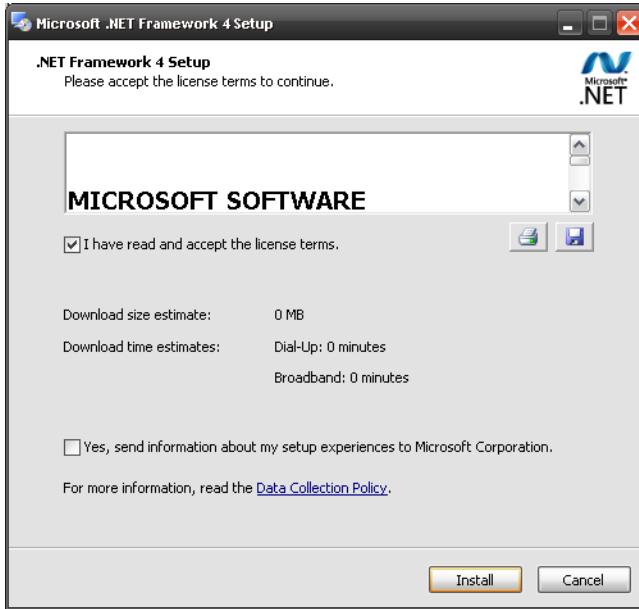

- 6 The next screen allows you to see the progress of the installation.

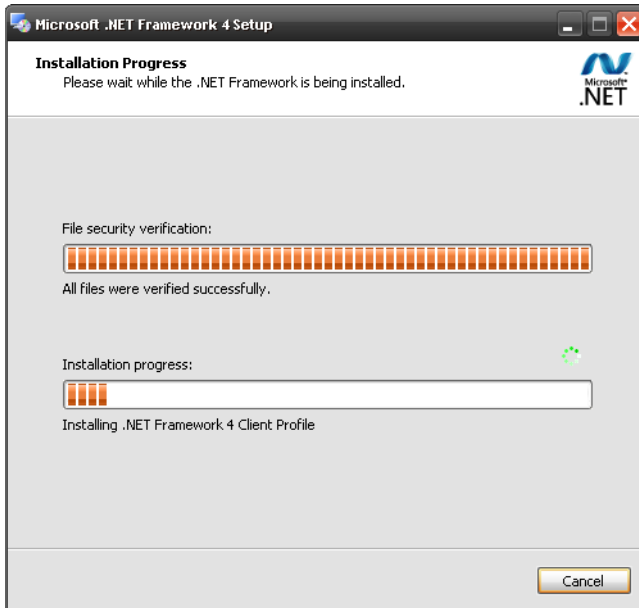

- 7 Click **Finish** to close the window.

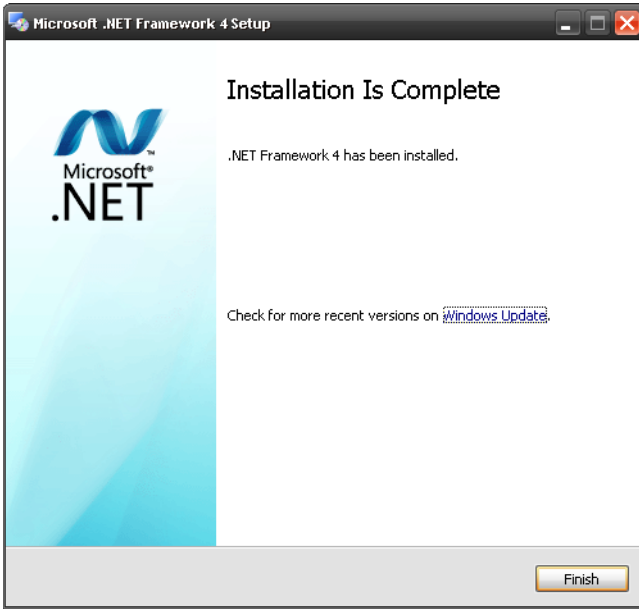

- 8 The utility installation wizard runs automatically. Click **Yes** or **Next** to continue through the initial screen. Click **Cancel** only if you want to abort the installation.

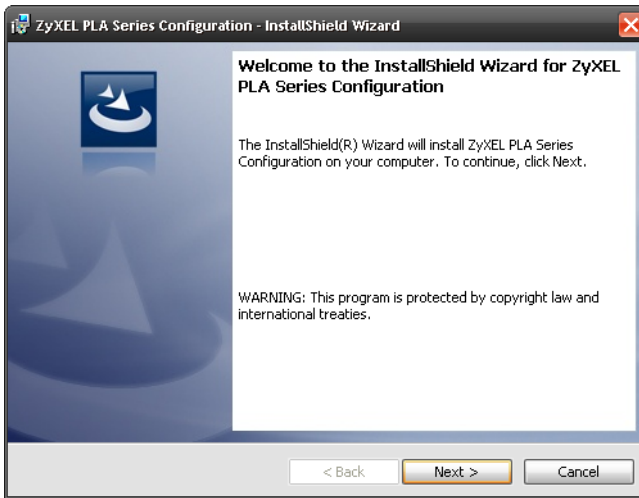

- 9 Click **Install** to install the utility to the default folder.

Figure 7 Install Destination Folder

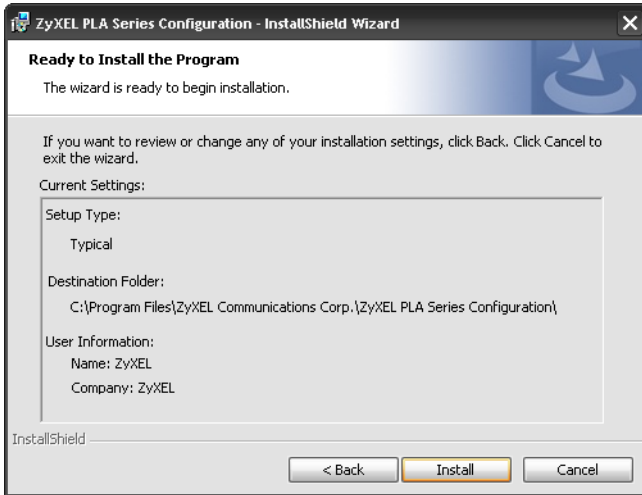

- 10 The screen shows you the progress of the installation.

Figure 8 Utility Installation Process

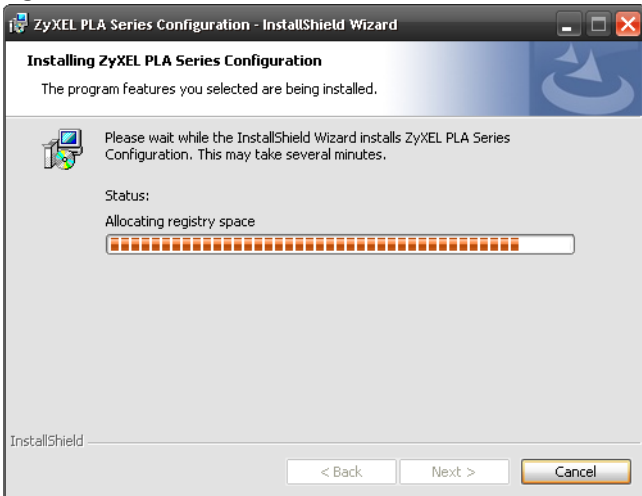

- 11 Click **Finish** to exit the wizard.

Figure 9 Installation Complete

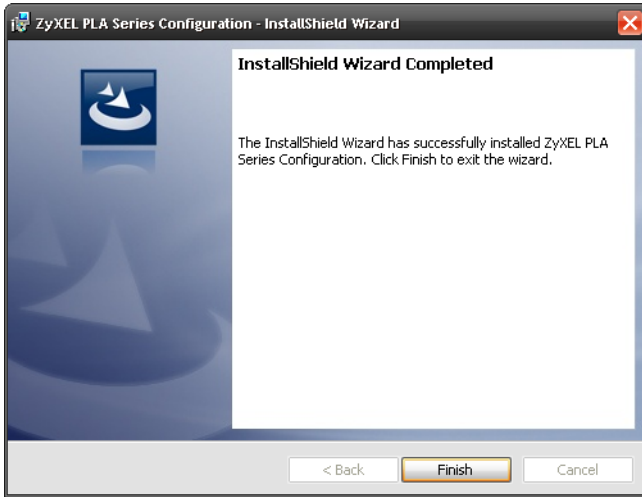

Note: You may be asked to restart your computer when the installation is complete. Click "Yes" to restart your computer. If you select "No, I will restart my computer later", you will not be able to launch the utility until after a restart of your computer.

CHAPTER 4

The Configuration Utility

4.1 Overview

This chapter shows you how to use the **Zyxel PLA Series Configuration** utility (or utility) to secure, manage and set up Quality of Service (QoS) on your Powerline network.

The PLA is designed as a plug-and-play network expanding solution. This means that once you complete your hardware connections, the PLAs in your network (without additional configuration) are able to communicate with each other by sending and receiving information over your home's electrical wiring (**A**).

Figure 10 Example Network Setup

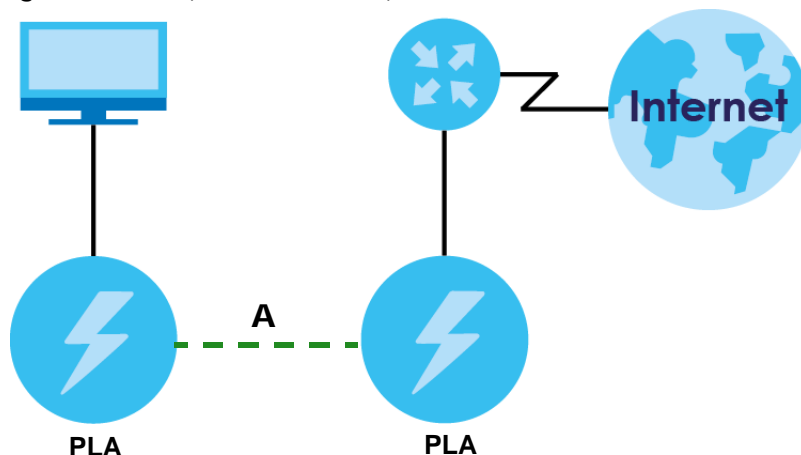

All HomePlug AV compliant Powerline adapters within range can join your network. The range varies depending on the quality of your home's wiring.

See [Section 4.1.1 on page 26](#) for more information on enhancing your Powerline network security.

Note: It is recommended to use the **Zyxel PLA Series Configuration** with PLA5206 independently.

4.1.1 Powerline Network Security

When the PLAs communicate with each other, they use encryption to protect the information that is sent in the Powerline network. Encryption is like a secret code. If you do not know the secret code, you cannot understand the message. The HomePlug AV standard uses 128-bit AES (Advanced Encryption Standard) to safely transmit data between Powerline adapters.

For the Powerline adapters to communicate with each other they all need to use the same network name. This network name allows the Powerline adapters to understand the encrypted information sent in the Powerline network.

By default the PLAs are all configured with the network name **HomePlugAV**, this allows you to simply plug the devices in and not worry about setting up security. If you want to enhance the security on your Powerline network, you can change the network name on the Powerline adapters you want to allow to communicate in your Powerline network.

4.1.2 Device Access Key (DAK)

In order to manage the Powerline adapters on your Powerline network you must enter the adapters' password in the **Zyxel PLA Series Configuration** utility. This password is called the DAK (Device Access Key) password. This password is printed on the Powerline adapter itself.

You don't need to enter the DAK password for the Powerline adapter directly connected to the computer running the utility (local Powerline adapter), you only have to add the remote Powerline adapters' passwords (those in your Powerline network, but not directly connected to your computer).

4.2 Starting the Configuration Utility

In Windows, to launch the **Zyxel PLA Series Configuration** utility simply double click on the utility icon on your desktop.



Figure 11 Zyxel PLA Series Configuration Utility Icon (Windows)



Alternatively, start the utility by browsing to it from the start menu. Click **Start > Programs > Zyxel PLA Series Configuration > PLA Series Configuration**.

4.3 Network Info Screen

Use the **Network Info** screen to see the rates at which a specific PLA is communicating with other Powerline adapters on your Powerline network.

You can select to view the connection status represented by icons ( icon) or view transmission/receiving rates in a list ( list).

4.3.1 Icon View

Use the up/down arrow or just click a device icon at the left side to select a Powerline adapter in your network. The screen shows you the network connection status of the selected device. Click **Refresh** to update the screen immediately.

Figure 12 Network Info Screen (Icon)

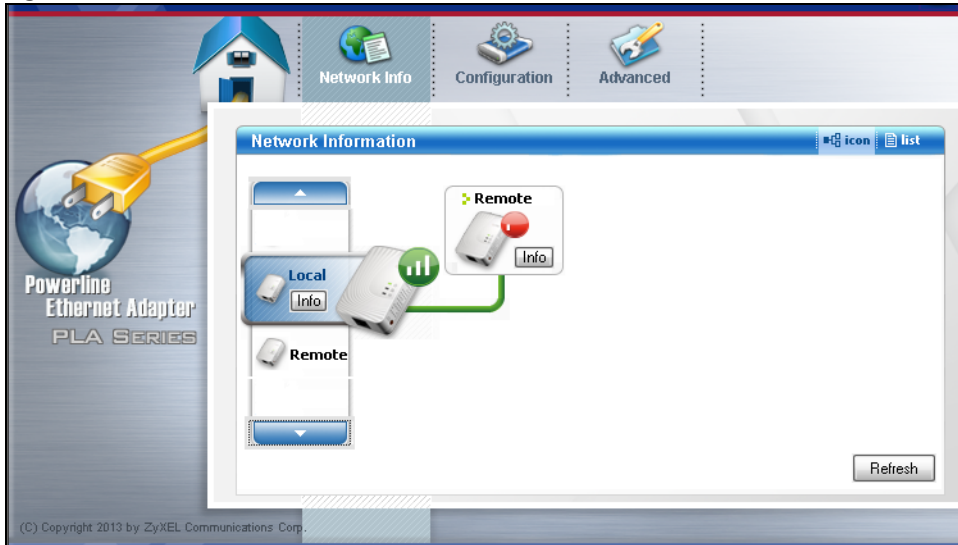

The connection status icon (, , or ) indicates the current data rate of the Powerline adapter, and is equivalent to the HomePlug LED. See [Chapter 1 on page 7](#) for more information.

In this mode, you can click a device's **Info** button to open a screen, where you can change the device's descriptive name that displays in this screen and view its MAC address and firmware version. The **Info** screen also shows you how fast the selected Powerline adapter sent information to or receive information from this device. For example, if the **Local** Powerline adapter is selected, a **Remote** Powerline adapter's **Info** screen also displays the rates of transmission from the Powerline adapter connected to the computer running the configuration utility to all the **Remote** Powerline adapters.

Figure 13 Network Info Screen (Icon) > Info

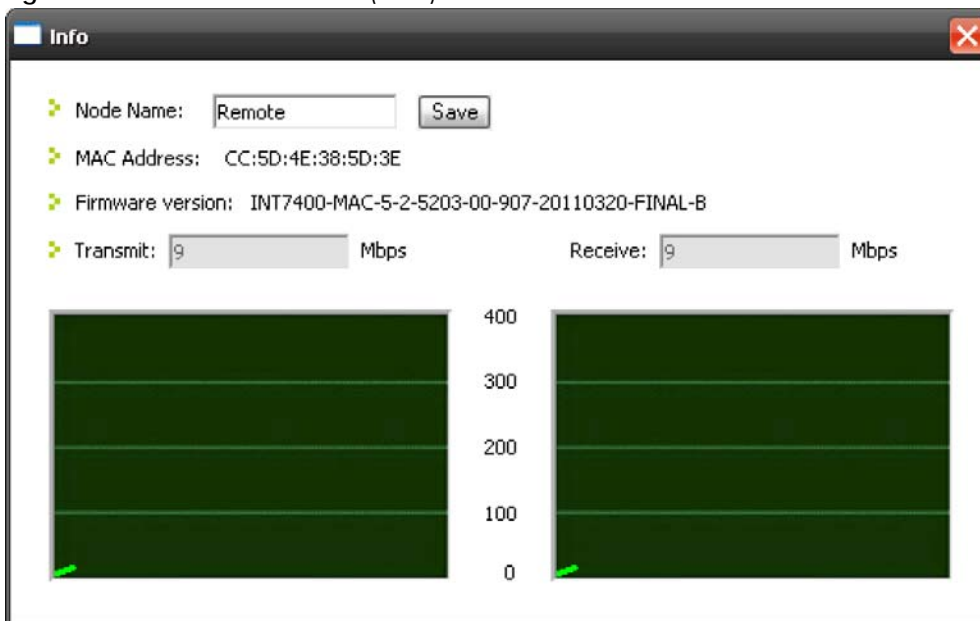

4.3.2 List View

Figure 14 Network Info Screen (List)

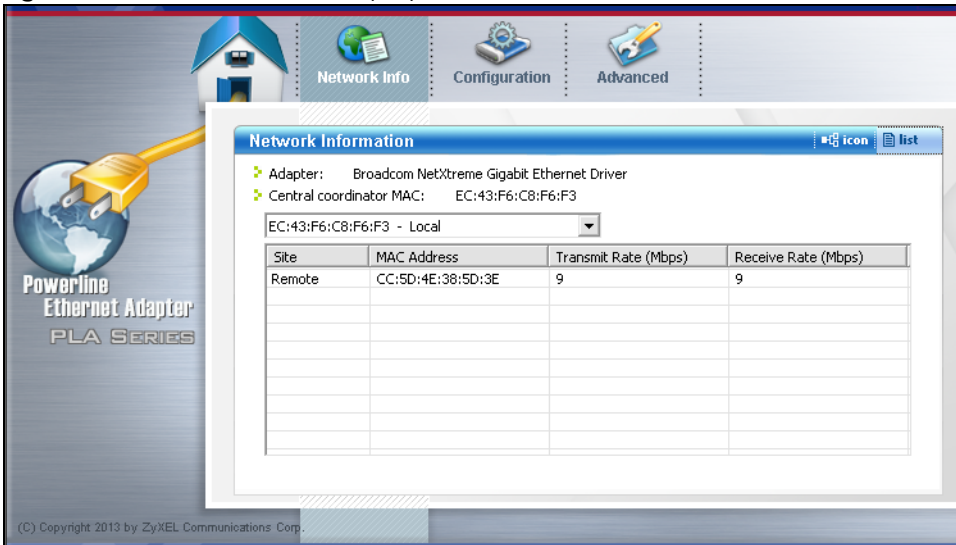

The following table describes the labels in this screen.

Table 8 Network Info Screen (List)

LABEL	DESCRIPTION
Adapter	This field identifies which Powerline network information is displayed. Different Powerline networks are identified by the Ethernet interface (network card) connected directly to the PLA. Typically there is only one connection, however, if your computer has two network cards and both are connected to a PLA, then you have two Powerline networks.
Central Coordinator MAC	The Central Coordinator of the Powerline network is the Powerline adapter which keeps track of which devices are part of the network as well as synchronizes communication within the Powerline network. If the Central Coordinator is removed from the Powerline network then another Powerline adapter takes its place. This field displays the MAC address of the PLA which is the Central Coordinator of the Powerline network. The Powerline adapters in your Powerline network automatically select the Central Coordinator.
Select a Powerline adapter from the drop-down box.	
The information provided in the following table reflects transmission rate information about the Powerline adapters which communicate in your Powerline network.	
The Powerline adapters listed in this table are all the Powerline adapters in your Powerline network except the selected Powerline adapter. In other words, if the Local Powerline adapter is selected, then this table will display the rates of transmission from the Powerline adapter connected to the computer running the configuration utility to all the Remote Powerline adapters.	
Site	This field displays: <ul style="list-style-type: none"> Local, if it is the PLA directly connected to the computer running the configuration utility. Remote, if it is a PLA in your Powerline network but not directly connected to the computer running the configuration utility.
MAC Address	This field displays the MAC address of your Powerline adapter. The MAC address of your Powerline adapter can be found by looking at the label on your device. It consists of six pairs of hexadecimal characters (hexadecimal characters are "0-9" and "a-f"). In the case of the PLA, this label is on the bottom of the device.

Table 8 Network Info Screen (List) (continued)

LABEL	DESCRIPTION
Transmit Rate (Mbps)	This field displays how fast information is sent from the selected Powerline adapter to this Powerline adapter. The rate is given in the following format: "application data transmission rate / raw data transmission rate". Application data reflects more accurately how fast devices are transmitting application relevant traffic (for example Internet Protocol (IP) traffic). Raw data refers to the whole payload of the packets transmitted across the Powerline network.
Receive Rate (Mbps)	This field displays how fast information is received from the selected Powerline adapter to this Powerline adapter. The rate is given in the following format: "application data transmission rate / raw data transmission rate". Application data reflects more accurately how fast devices are transmitting application relevant traffic (for example Internet Protocol (IP) traffic). Raw data refers to the whole payload of the packets transmitted across the Powerline network.

4.4 Configuration Screen

Use the **Configuration** screen to see which devices are recognized by your Powerline network, to configure your PLA and to set up a secure Powerline network by changing the Powerline network name. This screen opens up when you launch the utility.

Figure 15 Configuration Screen

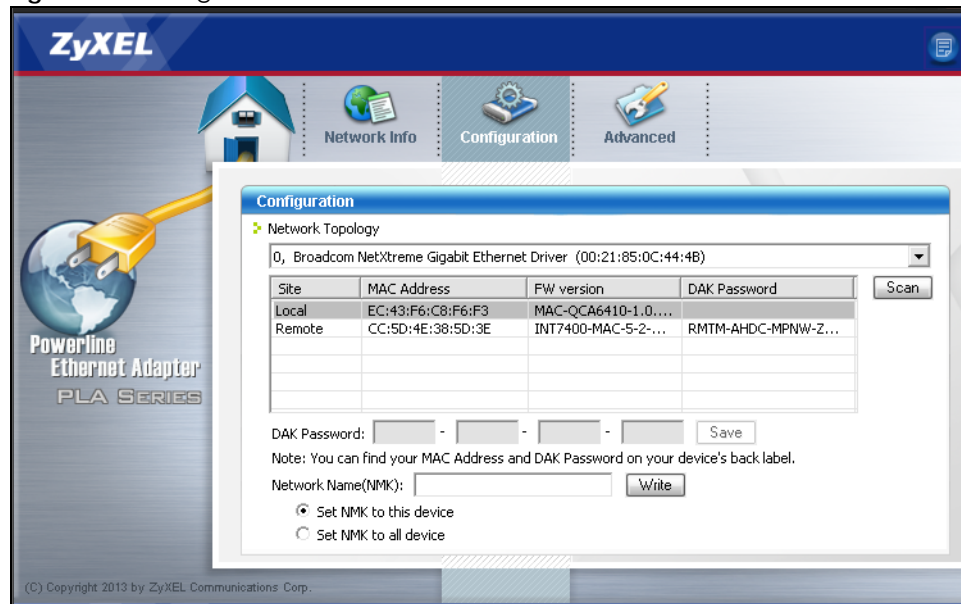

The following table describes the labels in this screen.

Table 9 Configuration Screen

LABEL	DESCRIPTION
Network Topology	Use this to select which Powerline network information is displayed. Different Powerline networks are identified by the Ethernet interface (network card) connected directly to the PLA. Typically there is only one connection, however, if your computer has two network cards and both are connected to a Powerline device then you have two Powerline networks.
The fields described below are used to identify the Powerline adapters recognized on the Powerline network. The configuration utility automatically updates this information every 10 seconds.	
Note: Only devices which share the same network name are displayed in this table.	

Table 9 Configuration Screen (continued)

LABEL	DESCRIPTION
Site	This field displays <ul style="list-style-type: none"> Local, if it is identifying the Powerline adapter directly connected to the computer running the configuration utility. Remote, if it is a Powerline adapter in your Powerline network but not directly connected to the computer running the configuration utility.
MAC Address	This is a read-only field which shows the MAC address of the Powerline adapter you are configuring. You can find the MAC address of your PLA displayed on a sticker on the bottom of your device.
FW version	This is a read-only field which shows the firmware version of the Powerline adapter in your network.
DAK Password	This is a read-only field which shows the DAK (Device Access Key) password of the remote Powerline adapter.
Scan	Click Scan to refresh the information in the table (immediately).
DAK Password	DAK (Device Access Key) password is used to verify that you are authorized to perform changes on a remote device. You can find the DAK password printed on a sticker on the bottom of your PLA. Select the remote Powerline adapter you want to manage by clicking the MAC address which corresponds to it in the MAC Address column. Enter the DAK Password value and click Save . Note: You must enter the DAK Password value exactly as it is printed on the label (all caps and with dashes "-").
Network Name (NMK)	The default network name (sometimes called a network password or network membership key (NMK)) of the PLA is " HomePlugAV ". HomePlug compatible devices use the same network name to recognize and communicate with each other over the Powerline network. If you change the network name of one device on the network, it will no longer be recognized as part of that network. If you change the network name, make sure you change the network name for all of the Powerline adapters that you want to be part of your Powerline network. The network name can be from 8 to 64 characters in length, using "A"~"Z", "a"~"z", "0"~"9"; spaces are not allowed.
Set NMK to this device	Select this to apply the NMK (entered in the field above) as the network name for the Powerline adapter directly connected to the computer running the configuration utility.
Set NMK to all devices	Select this to apply the NMK (entered in the field above) as the network name for all Powerline adapter detected by the utility.
Write	Click this to apply your changes. The new Network Name is applied to the selected Powerline adapter. Note: You must enter the correct DAK password for the selected remote Powerline adapter before you can make changes to it.

4.5 Advanced Screen

You can configure the Powerline adapters on your network to give priority to network traffic depending on its importance. When you set the priority of a Powerline adapter, you set how quickly messages FROM your Powerline adapter are sent in your Powerline network. Transmissions TO your Powerline adapter do not receive any priority.

For example, if you have a file server on your home network to deliver music and movie files to computers in your home, you should set the priority of the Powerline adapter connected to this server to **Medium**. If video traffic is delivered too slowly, quality problems may occur.

On the other hand, a Powerline adapter attached to a printer should have a low priority setting since the slow delivery of messages will not affect the print job.

Similarly, if you want to prioritize any downloads from the Internet, set the priority on the Powerline adapter attached to your Internet gateway to **High**.

Allocate priority settings based on application type as follows.

Table 10 Priority Settings

PRIORITY LEVEL	APPLICATION
High	Voice Application
Medium	Video and Audio Applications
Normal	Data Applications
Low	Data Applications

The figure below shows an example Powerline home network connected to the Internet.

- Device A is a printer and does not handle traffic with high importance, so the Powerline adapter connected to it can be set to low priority.
- Device B is a file server, delivering audio or movie files to other users on the network. The Powerline adapter attached to it should have a medium setting.
- Device C, a home computer which connects to the Internet, can receive a normal priority setting as it usually sends simple requests for data. For example, when you surf the Internet, your computer sends requests to open web pages.
- Device D is a modem attached to the Internet. It should receive a high priority setting if you want faster downloading through your network.
- Although device E receives audio or movie files, it does not send a lot of traffic, so the Powerline adaptor attached to it can be set to a low priority.

Figure 16 Priority Settings

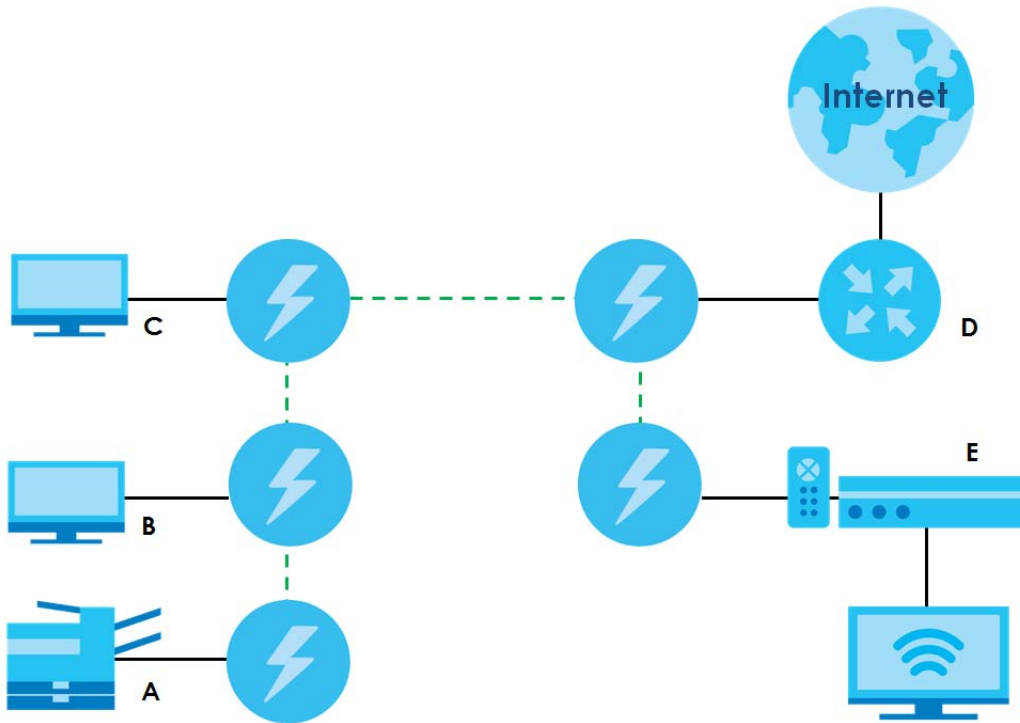

Use this screen to configure priority settings for traffic from the Powerline adapters on your network.

Figure 17 Advanced Screen

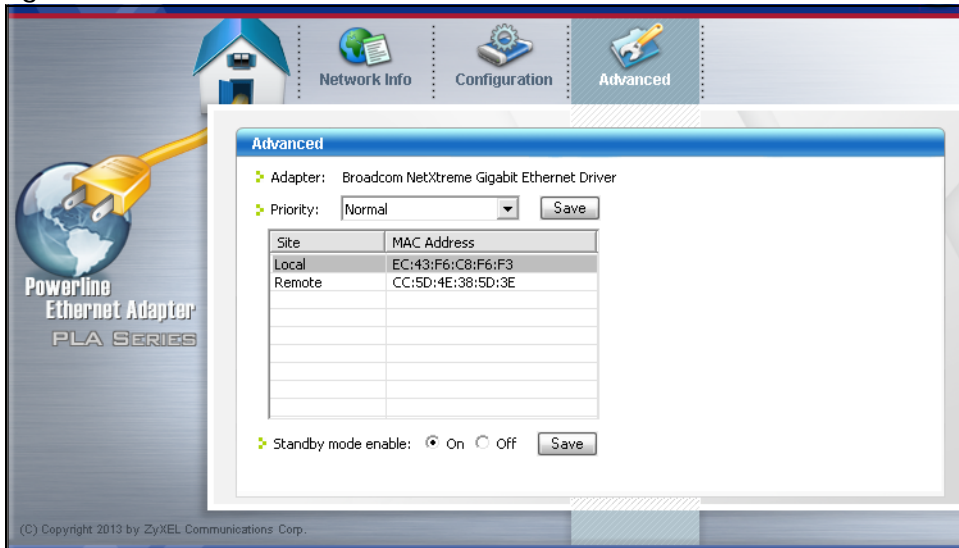

The following table describes the labels in this screen.

Table 11 Advanced Screen

LABEL	DESCRIPTION
Adapter	This field identifies which Powerline network information is displayed. Different Powerline networks are identified by the Ethernet interface (network card) on your computer which is connected directly to a Powerline adapter. Typically there is only one connection. However, if your computer has two network cards and both are connected to a Powerline adapter, then you have two Powerline networks.
Priority	Select a priority setting from the drop-down box for traffic FROM your selected device. The options, in order of importance, are High , Medium , Normal and Low .
Site	This field displays: <ul style="list-style-type: none"> • Local, if it is the PLA directly connected to the computer running the configuration utility. • Remote, if it is a Powerline adapter in your Powerline network but not directly connected to the computer running the configuration utility.
MAC Address	This is a read-only field which shows the MAC address of the Powerline adapter you are configuring. You can find the MAC address of your PLA displayed on a sticker on the bottom of your device.
Standby mode enable	Select On to have the selected Powerline adapter(s) go into standby mode when there is no Ethernet connection. Otherwise, select Off to have the adapter(s) never go into standby mode.
Save	Click this to apply your changes. The new Priority setting is applied to the selected Powerline adapter.

4.6 About Screen



Use the **About** screen to view information regarding the configuration utility version of the PLA you are connected to. Click the  icon in the top right corner of the utility to view the **About** screen.

Figure 18 About Screen

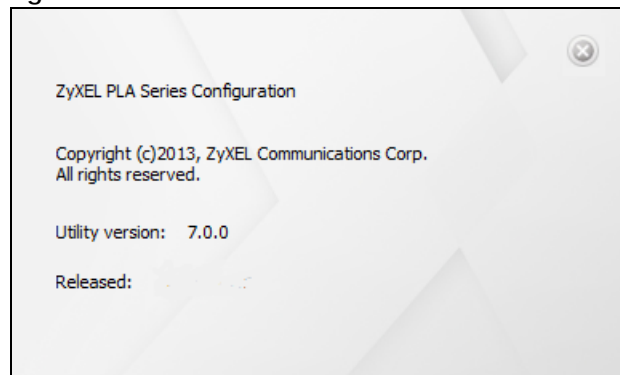

The following table describes the labels in this screen.

Table 12 About Screen

LABEL	DESCRIPTION
Utility version	This field displays the software version of the configuration utility.
Released	This field displays the date when the utility was released.
Close	Click the  button in upper right corner to close the About window.

CHAPTER 5

Powerline Network Setup

Tutorial

5.1 Overview

Use this tutorial to expand your existing Powerline network.

After setting up your first home Powerline network (instructions for that are in the Quick Start Guide for your Zyxel Powerline adapter) you may want to extend the network or create a new one by adding additional Powerline adapters. This tutorial shows you the following.

- How to start up your new Powerline adapter. You need to do this before you can begin the next sections.
- How to make your existing Powerline network bigger by adding new Powerline adapters.
- How to make a new network separate from your existing network with new Powerline adapters.
- How to make a new, separate Powerline network with the Powerline adapters you have.

The tutorial uses the **Zyxel PLA Series Configuration** utility to set up your Powerline adapter.

If you haven't already installed the utility, see [Chapter 3 on page 19](#) for instructions. The utility software is available for download at www.zyxel.com. Navigate to the Powerline products section of the Zyxel website to find this software. Follow the instructions provided by the software to install it on your computer.

See the product specifications in the User's Guide for a list of hardware and software compatible with the utility.

Note: The PLA in this tutorial is an example only. Your Powerline adapter may be different.

5.2 Important Terms

Network Name	The network name allows a Powerline adapter to connect with other Powerline adapters that have the same network name. It provides security for your Powerline network. The network name uses English letters or numbers, from 8 to 64 characters long, with no spaces allowed.
DAK Password	DAK = Device Access Key. The DAK Password lets you access the Powerline adapter. You can find the DAK Password on a label on your Powerline device.

5.3 Accessing Your Powerline Adapter

- 1 Plug the Powerline adapter you want to add to your network into a power socket and, if needed, switch the power socket on.

Figure 19 Plug Your Powerline Adapter into a Power Socket



1

- 2 Connect the Powerline adapter to your computer.
- 3 Use a LAN or Ethernet cable (shown below) to connect the LAN or Ethernet port on your adapter to the same kind of port on your computer.

Figure 20 Connect Your Powerline Adapter to a Computer

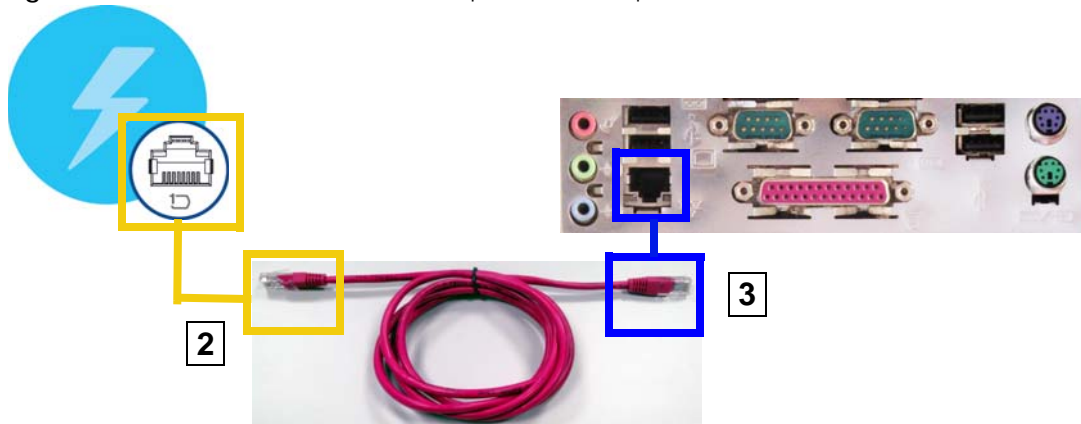

- 4 Open the **Zyxel PLA Series Configuration** utility on your computer. See [Section 4.2 on page 27](#) for how to launch the utility.
- 5 You are now ready to extend your Powerline network or set up a second network.
 - See [Section 5.4 on page 37](#) to add a new Powerline adapter to your network.
 - See [Section 5.5 on page 39](#) to set up a second network with your new adapters.
 - See [Section 5.6 on page 41](#) to set up a second network with your existing adapters.

5.4 Adding a Powerline Adapter

This section shows you how to add a new Powerline adapter to expand your existing network.

The figure below shows the family computer with Internet access on a Powerline network. Expand the network by adding a new Powerline adapter connected to a printer.

Figure 21 Add a Printer to Your Powerline Network

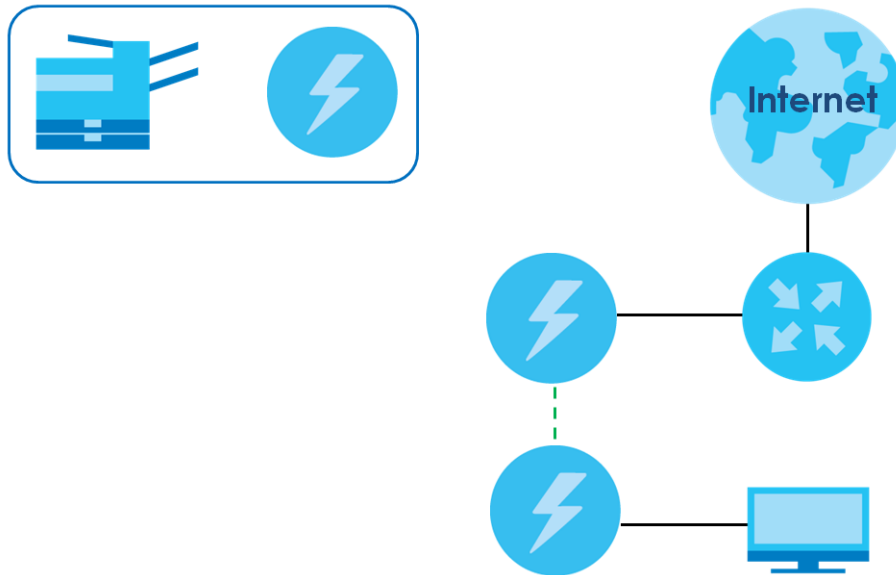

Note: You do not need to know the network name of the new adapter to add it to your network.

- 1 Connect your computer to the Powerline adapter you want to add to your network and open the **Zyxel PLA Series Configuration** utility (see [Section 5.3 on page 37](#)).
- 2 Go to the **Configuration** screen. On this screen in the **Site** column your new Powerline adapter should appear as **Local** (**A**). Check the **Local** adapter's MAC address (**B**). It should match the MAC address listed on the label on the back of your Powerline adapter.

Figure 22 Adding a New Adapter

Site	MAC Address	FW version	DAK Password
Local	C:43:F6:C8:F6:F3	MAC-QCA6410-1.0...	

DAK Password: [] - [] - [] - [] Save

Note: You can find your MAC Address and DAK Password on your device's back label.

Network Name(NMK): [] Write

Set NMK to this device
 Set NMK to all device

- 3 Select your adapter by selecting **Local** and type the network name for your existing network in the **Network Name** field (**C**).

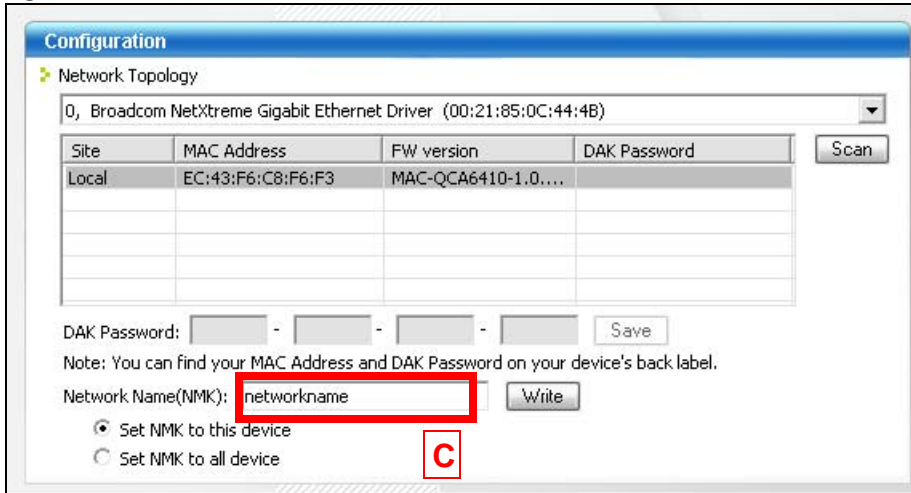
Figure 23 Adding an Adapter to an Existing Network

- 4 Click **Write** and click **OK** on the pop-up.

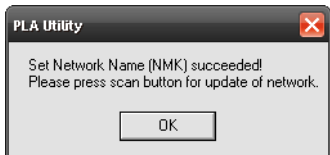
Figure 24 Network Name Pop-up

- 5 Your new adapter will now have the same **Network Name** as your existing network and so has now joined your existing network.
- 6 Connect the adapter to the device you want to add to the network, for example, your Internet refrigerator in the kitchen.
- 7 Plug the adapter's power cord into a power outlet and, if required, switch the power outlet on.
- 8 Repeat this procedure for all additional Powerline adapters that you want to add to your existing or new Powerline network.

5.5 Setting Up a New Network with a New Adapter

This section shows you how to use your new Powerline adapters to set up a new Powerline network separate to your existing network.

The figure below shows two Powerline networks in a house. The first network (1) shows the home computer connected to a printer and access to the Internet. The second network (2) has no Internet access but with a media adapter such as the Zyxel DMA-1100P you can use your TV to watch movies and play games which are stored on a computer.

Figure 25 Add New Adapters to Make a Second Network

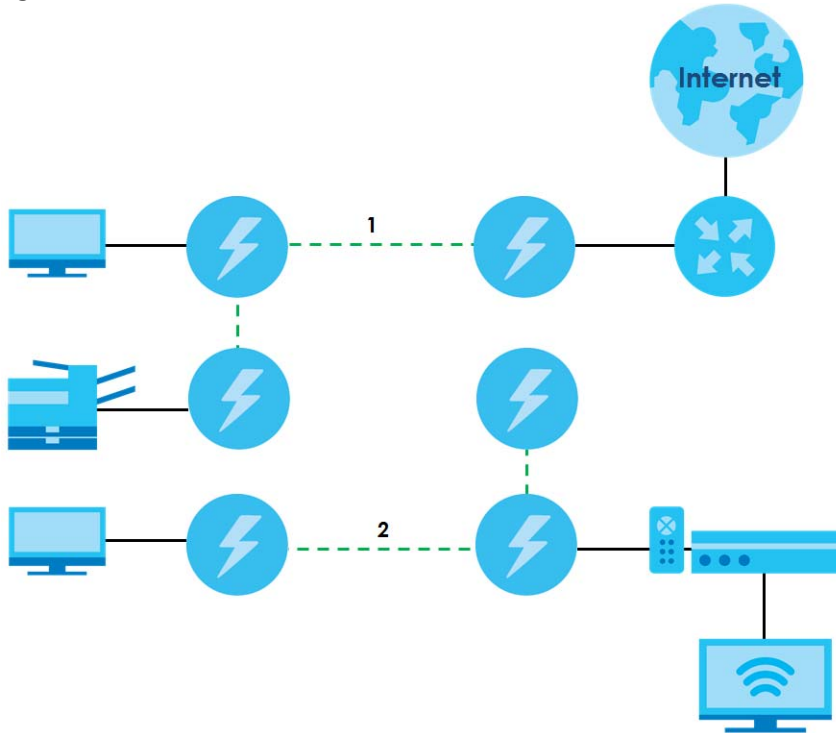

- 1 Connect your new Powerline adapter and open the configuration utility as shown in [Section 5.5 on page 39](#). The screen shown below appears.
- 2 Type a **Network Name** that is different from the **Network Name** for your existing network. Make sure you use the same new **Network Name** for all new adapters you want to add to your new network.

Figure 26 Making a New Network with the New Adapter

Configuration

Network Topology

0, Broadcom NetXtreme Gigabit Ethernet Driver (00:21:85:0C:44:4B)

Site	MAC Address	FW version	DAK Password
Local	EC:43:F6:C8:F6:F3	MAC-QCA6410-1.0....	

DAK Password: - - - Save

Note: You can find your MAC Address and DAK Password on your device's back label.

Network Name(NMK): Write

Set NMK to this device
 Set NMK to all device

- 3 After you have set up a new network, you are ready to connect each Powerline adapter on your new network to devices, for example, a computer or a games console.

5.6 Splitting a Network into Two Networks

This section shows you how to split your existing network into two networks. This is useful if you want to set up a second Powerline network in your home, for example, in your study connecting a laptop and printer. See [Figure 25 on page 40](#) for an example.

To set up your existing Powerline network you had to set each Powerline adapter with the same network name. To create a second (separate) Powerline network, configure the PLAs you want to add to the second network with a new network name.

- 1 Connect a Powerline adapter to your computer and open the **Zyxel PLA Series Configuration** utility (see [Section 5.3 on page 37](#)).
- 2 The utility should open to the configuration tab as shown below. A list of Powerline adapters on your network displays. These adapters all have the same network name as the adapter you are connected to. The adapter you are connected to will appear as **Local** in this table. All others are listed as **Remote**.

Figure 27 Local/Remote Adapters on a Powerline Network

Site	MAC Address	FW version	DAK Password
Local	EC:43:F6:C8:F6:F3	MAC-QCA6410-1.0....	
Remote	CC:5D:4E:38:5D:3E	INT7400-MAC-5-2-...	
Remote	CC:5D:4E:37:2D:3A	INT7400-MAC-5-2-...	

DAK Password: - - -

Note: You can find your MAC Address and DAK Password on your device's back label.

Network Name(NMK):

Set NMK to this device
 Set NMK to all device

- 3 To set up a new Powerline network, type the **DAK Password** and change the **Network Name** on all Powerline adapters you wish to add to your network.
 - Look for the **DAK Password** on a label on your Powerline adapter. The **DAK Password** lets you access the adapter.
 - Select the **Remote** adapter you want to add (**A**) and type the **DAK Password** in the **DAK Password** field (**B**).
 - Then type the new network name in the **Network Name** field (**C**).

Figure 28 Adding an Adapter to Your New Network

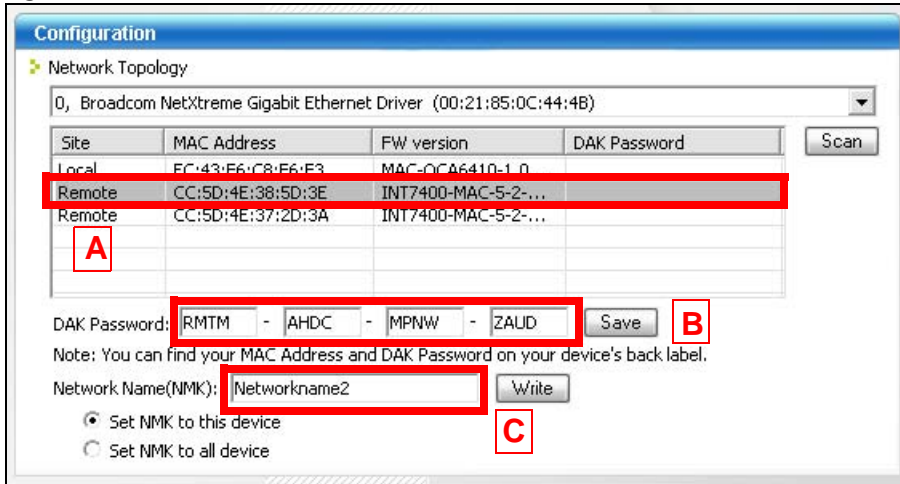

4 Click **Save**.

- If you do not type the **DAK password** or type it incorrectly the following pop-up appears. Click **OK** and type the **DAK Password** correctly in the **DAK Password** field.

Figure 29 Incorrect DAK or No DAK



- If you have correctly entered the **DAK Password**, click **OK** on the pop-up.

Figure 30 Correct DAK

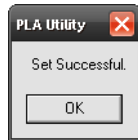

5 The adapter will disappear from the table of your existing network.

Figure 31 Adapters on Your Existing Network

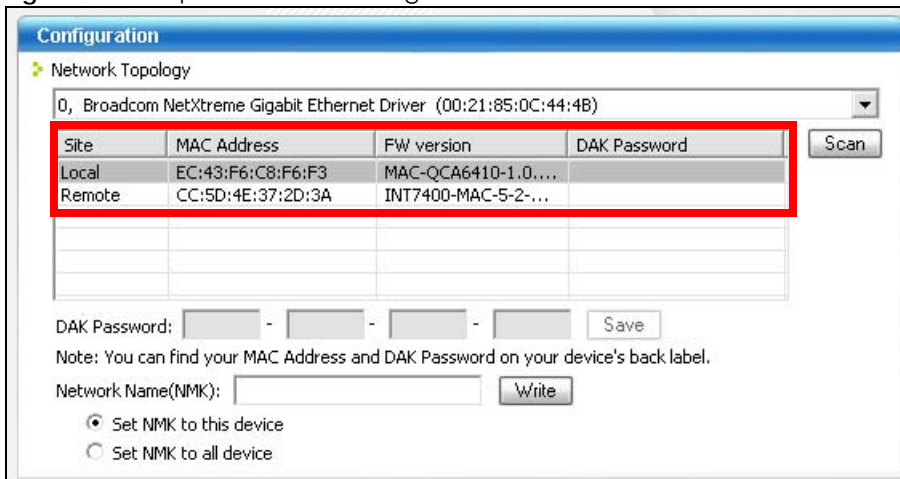

- 6 Go back to step 3 in this section to set the same, new **Network Name** for all remote adapters you want to add to your new network.
- 7 Check you have added the adapters correctly by changing the network name for the local adapter. All adapters with the new **Network Name** now appear in the list of adapters on your network. These adapters are now part of your new network.

Figure 32 Adapters on a New Powerline Network

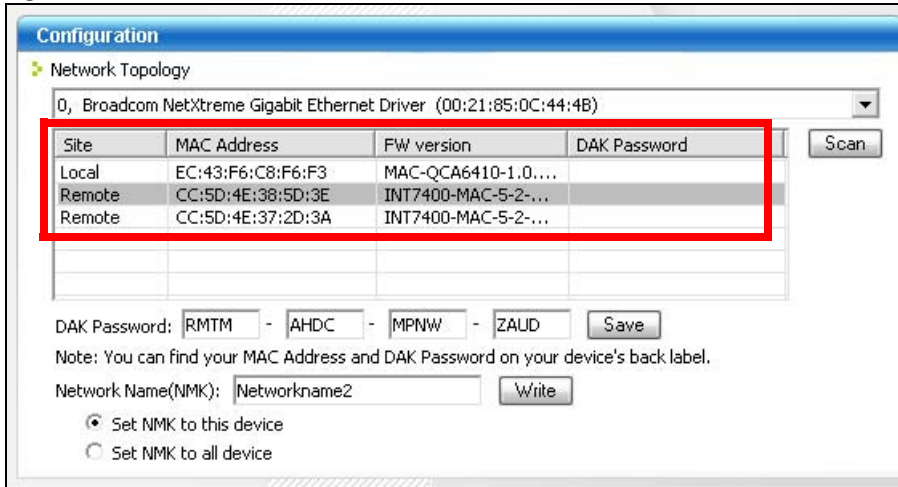

- If you want to access any of your new Powerline networks using the **Zyxel PLA Series Configuration** utility, change the **Network Name** on your local adapter to the network name for the network you want to access. The adapters on that network will then display in the adapter table, allowing you to select and configure each one.

5.7 Troubleshooting

The HomePlug (🏠) LED (light) should light up on your adapter when it successfully connects to other adapters on your network. If it does not, try the following measures.

- Make sure the adapter is plugged in to a power socket and the power socket is turned on.
- Check you have entered the correct network name for your network.
- Check your Powerline adapter is connected to the same electrical circuit as other Powerline adapters on your network.

CHAPTER 6

Troubleshooting

This chapter offers some suggestions to solve problems you might encounter.

6.1 Power and Light Problems

The PLA does not turn on. None of the lights turn on.

- 1 Disconnect and re-connect the PLA.
 - 2 Remove the Powerline adapter from the outlet. Then connect an electrical device that you know works into the same power outlet. This checks the status of the power outlet.
 - 3 If the problem continues, contact the vendor.
-

The ETHERNET light does not turn on.

- 1 Check the hardware connections. See the Quick Start Guide.
 - 2 Inspect your cables for damage. Contact the vendor to replace any damaged cables.
 - 3 Check the Ethernet adapter on your computer and make sure it's enabled and working properly.
 - 4 If the PLA is connected to an Ethernet switch or router, make sure the device is working correctly, and that the LAN network is working and configured correctly as well.
-

The HomePlug light does not turn on.

- 1 Use the **Zyxel PLA Series Configuration** utility to detect all other HomePlug devices on your Powerline network. Make sure that the network name (sometimes called the network password) is the same on all of your Powerline adapters. See [Section 4.4 on page 30](#) for instructions on changing the network name.
 - 2 Check the DAK password and MAC address for all Powerline adapters are typed correctly in the utility. See [Section 4.4 on page 30](#) for instructions on checking the DAK and MAC address.
-

- 3 Make sure that all your Powerline adapters are HomePlug AV compliant. Check the package it came in or ask your vendor. This PLA can not detect earlier versions of HomePlug Powerline adapters such as HomePlug 1.0 or 1.0.1. (Although they can coexist on the same electrical wiring without interfering with each other.)
- 4 Make sure that the Powerline adapters on your network are all on the same electrical wiring. Connect another Powerline adapter into an outlet close to your PLA's power outlet. They are probably now on the same electrical wiring. Check the HomePlug () light. If it now lights up your Powerline adapter was probably previously on separate electrical wiring. Ask an electrician for more information on the electrical wiring in your building.
- 5 Make sure that you do not have a power meter between Powerline adapters. Powerline signals cannot pass this.

The **POWER** and HomePlug light blink at the same time.

- You have pressed the **RESET/ENCRYPT** button for more than three seconds. Try setting up a connection again, this time pressing the **RESET/ENCRYPT** buttons on both devices for less than three seconds.

6.2 Configuration Utility Problems

The **Zyxel PLA Series Configuration** utility displays an error during installation.

- Make sure your computer is using the supported operating system. See [Section 3.1.1 on page 19](#) for more information.

The **Zyxel PLA Series Configuration** utility does not display all or any of my devices.

- Inspect the LEDs on your PLA and make sure that the ETHERNET and HomePlug LEDs are on or blinking. See [Section 1.2 on page 7](#) for troubleshooting LED related problems.
- Check you are using the latest version utility. Earlier version utilities cannot communicate with PLAs using the latest firmware. If you do not have the latest utility, download it from the Zyxel website.
- If you are running another tool such as the **Firmware Detection Tool**, the utility will not detect your local device.
- If your computer has more than one network interface card (NIC), make sure you select the right NIC to which the PLA is connected in the utility's **Configuration** screen.

6.3 Powerline Problems

The signal on my Powerline network is weak.

- 1 Your Powerline adapters may be connected to electrical surge protectors. Connect them to standard power outlets.
- 2 Your Powerline adapters may be located close to large appliances such as refrigerators or air-conditioners that cause interference with the Powerline signal. Move the adapters further away from such appliances to reduce interference.
- 3 Your Powerline adapters may be placed close to electrical devices such as electrical insect-killers which produce radio waves. These may interfere with the Powerline signals. Move the adapters further away from such electrical devices.
- 4 Your wiring may be old and/or low quality or with a long wiring path.

6.4 RESET/ENCRYPT Button Problems

This section applies only to PLAs with the **RESET/ENCRYPT** button. In this guide **RESET/ENCRYPT** refers to the **ENCRYPT** button in PLAs that have separate **RESET** and **ENCRYPT** buttons. Refer to [Table 1 on page 6](#) to see which models have separate **RESET** and **ENCRYPT** buttons.

The HomePlug light is already on, but I haven't pressed the RESET/ENCRYPT button yet.

Your device has already connected to another Powerline device. Press the **RESET/ENCRYPT** button for 5 to 8 seconds to release the connection. For models with separate buttons, press the **ENCRYPT** button for more than 10 seconds to release the connection.

The POWER light does not blink when I press the RESET/ENCRYPT button.

- Check the device is on.
- Press the **RESET/ENCRYPT** button again, making certain you have pressed the button for 0.5 to 3 seconds.
- The POWER light on some Powerline devices do not blink as part of the ENCRYPT process. Check your Powerline device is a PLA.
- For PLA, you cannot use the **RESET/ENCRYPT** button when it is in standby mode. Connect the PLA to a computer/router then try again.

The POWER light blinks two times quickly then pauses, before repeating.

The ENCRYPT process has failed. Press the **RESET/ENCRYPT** button on both devices for 5 to 8 seconds, then try to reconnect. For models with separate buttons, press the **ENCRYPT** button for more than 10 seconds to release the connection.

The POWER lights on both devices blink when I press the RESET/ENCRYPT buttons, but the HomePlug light does not turn on.

- Ensure you have pressed the **RESET/ENCRYPT** button on both devices.
- Wait for about a minute while the devices set up a connection.
- If that does not work, try again with both devices connected to a power strip next to each other. If they now connect, then the devices were not on the same electrical circuit before.

The POWER lights on both devices blink, then many lights blink and the HomePlug light blinks red.

Do not worry, the connection process is proceeding normally.

The POWER lights on both devices finished blinking, but only one device's HomePlug light is on.

One device may have connected to a third Powerline device. To check device A is connected to device B and not another device, disconnect device B from its power source. Device A's HomePlug () light will turn off if the connection is with Device B. Press the **RESET/ENCRYPT** button on both devices for 5 to 8 seconds (for models with separate buttons, press the **ENCRYPT** button for more than 10 seconds), then try to reconnect, pressing the **RESET/ENCRYPT** button for 0.5 to 3 seconds on both devices.

I pressed the RESET/ENCRYPT button for 5 to 8 seconds, but the HomePlug light is still on.

The HomePlug light is on, indicating it is still connected to another Powerline device. Try again, pressing the **RESET/ENCRYPT** button for 5 to 8 seconds. For models with separate buttons, press the **ENCRYPT** button for more than 10 seconds to release the connection.

APPENDIX A

Customer Support

In the event of problems that cannot be solved by using this manual, you should contact your vendor. If you cannot contact your vendor, then contact a Zyxel office for the region in which you bought the device.

See <http://www.zyxel.com/homepage.shtml> and also http://www.zyxel.com/about_zyxel/zyxel_worldwide.shtml for the latest information.

Please have the following information ready when you contact an office.

Required Information

- Product model and serial number.
- Warranty Information.
- Date that you received your device.
- Brief description of the problem and the steps you took to solve it.

Corporate Headquarters (Worldwide)

Taiwan

- Zyxel Communications Corporation
- <http://www.zyxel.com>

Asia

China

- Zyxel Communications (Shanghai) Corp.
- Zyxel Communications (Beijing) Corp.
- Zyxel Communications (Tianjin) Corp.
- <http://www.zyxel.cn>

India

- Zyxel Technology India Pvt Ltd
- <http://www.zyxel.in>

Kazakhstan

- Zyxel Kazakhstan
- <http://www.zyxel.kz>

Korea

- Zyxel Korea Corp.
- <http://www.zyxel.kr>

Malaysia

- Zyxel Malaysia Sdn Bhd.
- <http://www.zyxel.com.my>

Pakistan

- Zyxel Pakistan (Pvt.) Ltd.
- <http://www.zyxel.com.pk>

Philippines

- Zyxel Philippines
- <http://www.zyxel.com.ph>

Singapore

- Zyxel Singapore Pte Ltd.
- <http://www.zyxel.com.sg>

Taiwan

- Zyxel Communications Corporation
- <http://www.zyxel.com/tw/zh/>

Thailand

- Zyxel Thailand Co., Ltd
- <http://www.zyxel.co.th>

Vietnam

- Zyxel Communications Corporation-Vietnam Office
- <http://www.zyxel.com/vn/vi>

Europe

Austria

- Zyxel Deutschland GmbH
- <http://www.zyxel.de>

Belarus

- Zyxel BY
- <http://www.zyxel.by>

Belgium

- Zyxel Communications B.V.
- <http://www.zyxel.com/be/nl/>
- <http://www.zyxel.com/be/fr/>

Bulgaria

- Zyxel България
- <http://www.zyxel.com/bg/bg/>

Czech Republic

- Zyxel Communications Czech s.r.o
- <http://www.zyxel.cz>

Denmark

- Zyxel Communications A/S
- <http://www.zyxel.dk>

Estonia

- Zyxel Estonia
- <http://www.zyxel.com/ee/et/>

Finland

- Zyxel Communications
- <http://www.zyxel.fi>

France

- Zyxel France
- <http://www.zyxel.fr>

Germany

- Zyxel Deutschland GmbH
- <http://www.zyxel.de>

Hungary

- Zyxel Hungary & SEE
- <http://www.zyxel.hu>

Italy

- Zyxel Communications Italy
- <http://www.zyxel.it/>

Latvia

- Zyxel Latvia
- <http://www.zyxel.com/lv/lv/homepage.shtml>

Lithuania

- Zyxel Lithuania
- <http://www.zyxel.com/lt/lt/homepage.shtml>

Netherlands

- Zyxel Benelux
- <http://www.zyxel.nl>

Norway

- Zyxel Communications
- <http://www.zyxel.no>

Poland

- Zyxel Communications Poland
- <http://www.zyxel.pl>

Romania

- Zyxel Romania
- <http://www.zyxel.com/ro/ro>

Russia

- Zyxel Russia
- <http://www.zyxel.ru>

Slovakia

- Zyxel Communications Czech s.r.o. organizacna zlozka
- <http://www.zyxel.sk>

Spain

- Zyxel Communications ES Ltd
- <http://www.zyxel.es>

Sweden

- Zyxel Communications
- <http://www.zyxel.se>

Switzerland

- Studerus AG

- <http://www.zyxel.ch/>

Turkey

- Zyxel Turkey A.S.
- <http://www.zyxel.com.tr>

UK

- Zyxel Communications UK Ltd.
- <http://www.zyxel.co.uk>

Ukraine

- Zyxel Ukraine
- <http://www.ua.zyxel.com>

Latin America

Argentina

- Zyxel Communication Corporation
- <http://www.zyxel.com/ec/es/>

Brazil

- Zyxel Communications Brasil Ltda.
- <https://www.zyxel.com/br/pt/>

Ecuador

- Zyxel Communication Corporation
- <http://www.zyxel.com/ec/es/>

Middle East

Israel

- Zyxel Communication Corporation
- <http://il.zyxel.com/homepage.shtml>

Middle East

- Zyxel Communication Corporation
- <http://www.zyxel.com/me/en/>

North America

USA

- Zyxel Communications, Inc. - North America Headquarters
- <http://www.zyxel.com/us/en/>

Oceania

Australia

- Zyxel Communications Corporation
- <http://www.zyxel.com/au/en/>

Africa

South Africa

- Nology (Pty) Ltd.
- <http://www.zyxel.co.za>

APPENDIX B

Legal Information

Copyright

Copyright © 2018 by Zyxel Communications Corporation.

The contents of this publication may not be reproduced in any part or as a whole, transcribed, stored in a retrieval system, translated into any language, or transmitted in any form or by any means, electronic, mechanical, magnetic, optical, chemical, photocopying, manual, or otherwise, without the prior written permission of Zyxel Communications Corporation.

Published by Zyxel Communications Corporation. All rights reserved.

Disclaimer

Zyxel does not assume any liability arising out of the application or use of any products, or software described herein. Neither does it convey any license under its patent rights nor the patent rights of others. Zyxel further reserves the right to make changes in any products described herein without notice. This publication is subject to change without notice.

Regulatory Notice and Statement

United States of America



The following information applies if you use the product within USA area.

FCC EMC Statement

- The device complies with Part 15 of FCC rules. Operation is subject to the following two conditions:
 - (1) This device may not cause harmful interference, and
 - (2) This device must accept any interference received, including interference that may cause undesired operation.
- Changes or modifications not expressly approved by the party responsible for compliance could void the user's authority to operate the device.
- This product has been tested and complies with the specifications for a Class B digital device, pursuant to Part 15 of the FCC Rules. These limits are designed to provide reasonable protection against harmful interference in a residential installation. This device generates, uses, and can radiate radio frequency energy and, if not installed and used according to the instructions, may cause harmful interference to radio communications. However, there is no guarantee that interference will not occur in a particular installation.
- If this device does cause harmful interference to radio or television reception, which is found by turning the device off and on, the user is encouraged to try to correct the interference by one or more of the following measures:
 - Reorient or relocate the receiving antenna
 - Increase the separation between the devices
 - Connect the equipment to an outlet other than the receiver's
 - Consult a dealer or an experienced radio/TV technician for assistance

Canada

The following information applies if you use the product within Canada area

Industry Canada ICES Statement

CAN ICES-3 (B)/NMB-3(B)

CAN ICES-6/NMB-6

EUROPEAN UNION



List of national codes

COUNTRY	ISO 3166 2 LETTER CODE	COUNTRY	ISO 3166 2 LETTER CODE
Austria	AT	Liechtenstein	LI
Belgium	BE	Lithuania	LT
Bulgaria	BG	Luxembourg	LU
Croatia	HR	Malta	MT
Cyprus	CY	Netherlands	NL
Czech Republic	CZ	Norway	NO
Denmark	DK	Poland	PL
Estonia	EE	Portugal	PT
Finland	FI	Romania	RO
France	FR	Serbia	RS
Germany	DE	Slovakia	SK
Greece	GR	Slovenia	SI
Hungary	HU	Spain	ES
Iceland	IS	Switzerland	CH
Ireland	IE	Sweden	SE
Italy	IT	Turkey	TR
Latvia	LV	United Kingdom	GB

Safety Warnings

- Do not use this product near water, for example, in a wet basement or near a swimming pool.
- Do not expose your device to dampness, dust or corrosive liquids.
- Do not store things on the device.
- Do not install, use, or service this device during a thunderstorm. There is a remote risk of electric shock from lightning.
- Connect ONLY suitable accessories to the device.
- Do not open the device or unit. Opening or removing covers can expose you to dangerous high voltage points or other risks. ONLY qualified service personnel should service or disassemble this device. Please contact your vendor for further information.
- Make sure to connect the cables to the correct ports.
- Place connecting cables carefully so that no one will step on them or stumble over them.
- Always disconnect all cables from this device before servicing or disassembling.
- Do not remove the plug and connect it to a power outlet by itself; always attach the plug to the power adaptor first before connecting it to a power outlet.
- Do not allow anything to rest on the power adaptor or cord and do NOT place the product where anyone can walk on the power adaptor or cord.
- Please use the provided or designated connection cables/power cables/ adaptors. Connect it to the right supply voltage (for example, 110V AC in North America or 230V AC in Europe). If the power adaptor or cord is damaged, it might cause electrocution. Remove it from the device and the power source, repairing the power adapter or cord is prohibited. Contact your local vendor to order a new one.
- Do not use the device outside, and make sure all the connections are indoors. There is a remote risk of electric shock from lightning.
- CAUTION: Risk of explosion if battery is replaced by an incorrect type, dispose of used batteries according to the instruction. Dispose them at the applicable collection point for the recycling of electrical and electronic devices. For detailed information about recycling of this product, please contact your local city office, your household waste disposal service or the store where you purchased the product.
- Do not obstruct the device ventilation slots, as insufficient airflow may harm your device. For example, do not place the device in an enclosed space such as a box or on a very soft surface such as a bed or sofa.
- The following warning statements apply, where the disconnect device is not incorporated in the device or where the plug on the power supply cord is intended to serve as the disconnect device,
 - For permanently connected devices, a readily accessible disconnect device shall be incorporated external to the device;
 - For pluggable devices, the socket-outlet shall be installed near the device and shall be easily accessible.

IMPORTANT SAFETY INSTRUCTIONS

- Caution! The RJ-45 jacks are not used for telephone line connection.
- Caution! To reduce the risk of fire, use only No. 26 AWG or larger (e.g., 24 AWG) UL Listed or CSA Certified Telecommunication Line Cord.
- Caution! Do not use this product near water, for example a wet basement or near a swimming pool.
- Caution! Avoid using this product (other than a cordless type) during an electrical storm. There may be a remote risk of electric shock from lightning.
- Caution! Always disconnect all telephone lines from the wall outlet before servicing or disassembling this product.
- Attention : Les prises RJ-45 ne sont pas utilisés pour la connexion de la ligne téléphonique.
- Attention : Pour réduire les risques d'incendie n'utiliser que des câbles de type 26 AWG ou des câbles de connexion plus épais
- Attention : Ne pas utiliser ce produit près de l'eau, par exemple un sous-sol humide ou près d'une piscine.
- Attention : Évitez d'utiliser ce produit (autre qu'un type sans fil) pendant un orage. Il peut y avoir un risque de choc électrique de la foudre.
- Attention : Toujours débrancher toutes les lignes téléphoniques de la prise murale avant de réparer ou de démonter ce produit.

Environment Statement

ErP (Energy-related Products)

Zyxel products put on the EU market in compliance with the requirement of the European Parliament and the Council published Directive 2009/125/EC establishing a framework for the setting of ecodesign requirements for energy-related products (recast), so called as "ErP Directive (Energy-related Products directive) as well as ecodesign requirement laid down in applicable implementing measures, power consumption has satisfied regulation requirements which are:

- Network standby power consumption < 8W, and/or
- Off mode power consumption < 0.5W, and/or
- Standby mode power consumption < 0.5W.

European Union - Disposal and Recycling Information

The symbol below means that according to local regulations your product and/or its battery shall be disposed of separately from domestic waste. If this product is end of life, take it to a recycling station designated by local authorities. At the time of disposal, the separate collection of your product and/or its battery will help save natural resources and ensure that the environment is sustainable development.

Die folgende Symbol bedeutet, dass Ihr Produkt und/oder seine Batterie gemäß den örtlichen Bestimmungen getrennt vom Hausmüll entsorgt werden muss. Wenden Sie sich an eine Recyclingstation, wenn dieses Produkt das Ende seiner Lebensdauer erreicht hat. Zum Zeitpunkt der Entsorgung wird die getrennte Sammlung von Produkt und/oder seiner Batterie dazu beitragen, natürliche Ressourcen zu sparen und die Umwelt und die menschliche Gesundheit zu schützen.

El símbolo de abajo indica que según las regulaciones locales, su producto y/o su batería deberán depositarse como basura separada de la doméstica. Cuando este producto alcance el final de su vida útil, llévelo a un punto limpio. Cuando llegue el momento de desechar el producto, la recogida por separado éste y/o su batería ayudará a salvar los recursos naturales y a proteger la salud humana y medioambiental.

Le symbole ci-dessous signifie que selon les réglementations locales votre produit et/ou sa batterie doivent être éliminés séparément des ordures ménagères. Lorsque ce produit atteint sa fin de vie, amenez-le à un centre de recyclage. Au moment de la mise au rebut, la collecte séparée de votre produit et/ou de sa batterie aidera à économiser les ressources naturelles et protéger l'environnement et la santé humaine.

Il simbolo sotto significa che secondo i regolamenti locali il vostro prodotto e/o batteria deve essere smaltito separatamente dai rifiuti domestici. Quando questo prodotto raggiunge la fine della vita di servizio portarlo a una stazione di riciclaggio. Al momento dello smaltimento, la raccolta separata del vostro prodotto e/o della sua batteria aiuta a risparmiare risorse naturali e a proteggere l'ambiente e la salute umana.

Symbolen innebär att enligt lokal lagstiftning ska produkten och/eller dess batteri kastas separat från hushållsavfallet. När den här produkten når slutet av sin livslängd ska du ta den till en återvinningsstation. Vid tiden för kasseringen bidrar du till en bättre miljö och mänsklig hälsa genom att göra dig av med den på ett återvinningsställe.



台灣



以下訊息僅適用於產品具有無線功能且銷售至台灣地區

- 第十二條 經型式認證合格之低功率射頻電機，非經許可，公司，商號或使用者均不得擅自變更頻率、加大功率或變更原設計之特性及功能。
- 第十四條 低功率射頻電機之使用不得影響飛航安全及干擾合法通信；經發現有干擾現象時，應立即停用，並改善至無干擾時方得繼續使用。前項合法通信，指依電信法規定作業之無線電通信。低功率射頻電機須忍受合法通信或工業、科學及醫療用電波輻射性電機設備之干擾。
- 電磁波曝露量 MPE 標準值 1mW/cm²，送測產品實測值為：XX mW/cm²。本產品使用時建議應距離人體 XX cm。
- 無線資訊傳輸設備忍受合法通信之干擾且不得干擾合法通信；如造成干擾，應立即停用，俟無干擾之虞，始得繼續使用。
- 無線資訊傳輸設備的製造廠商應確保頻率穩定性，如依製造廠商使用手冊上所述正常操作，發射的信號應維持於操作頻帶中

以下訊息僅適用於產品操作於 5.25-5.35 兆赫頻帶內並銷售至台灣地區

- 在 5.25-5.35 兆赫頻帶內操作之無線資訊傳輸設備，限於室內使用。

以下訊息僅適用於產品屬於專業安裝並銷售至台灣地區

- 本器材須經專業工程人員安裝及設定，始得 設置使用，且不得直接販售給一般消費者



安全警告 - 為了您的安全，請先閱讀以下警告及指示：

- 請勿將此產品接近水、火焰或放置在高溫的環境。
- 避免設備接觸
 - 任何液體 - 切勿讓設備接觸水、雨水、高濕度、污水腐蝕性的液體或其他水份。
 - 灰塵及污物 - 切勿接觸灰塵、污物、沙土、食物或其他不合適的材料。
- 雷雨天氣時，不要安裝，使用或維修此設備。有遭受電擊的風險。
- 切勿重摔或撞擊設備，並勿使用不正確的電源變壓器。
- 若接上不正確的電源變壓器會有爆炸的風險。
- 請勿隨意更換產品內的電池。
- 如果更換不正確之電池型式，會有爆炸的風險，請依製造商說明書處理使用過之電池。
- 請將廢電池丟棄在適當的電器或電子設備回收處。
- 請勿將設備解體。
- 請勿阻礙設備的散熱孔，空氣對流不足將會造成設備損害。
- 請插在正確的電壓供給插座（如：北美 / 台灣電壓 110V AC，歐洲是 230V AC）。
- 假若電源變壓器或電源變壓器的纜線損壞，請從插座拔除，若您還繼續插電使用，會有觸電死亡的風險。
- 請勿試圖修理電源變壓器或電源變壓器的纜線，若有毀損，請直接聯絡您購買的店家，購買一個新的電源變壓器。
- 請勿將此設備安裝於室外，此設備僅適合放置於室內。
- 請勿隨一般垃圾丟棄。
- 請參閱產品背貼上的設備額定功率。
- 請參考產品型錄或是彩盒上的作業溫度。
- 產品沒有斷電裝置或者採用電源線的插頭視為斷電裝置的一部分，以下警語將適用：
 - 對永久連接之設備，在設備外部須安裝可觸及之斷電裝置；
 - 對插接式之設備，插座必須接近安裝之地點而且是易於觸及的。

About the Symbols

Various symbols are used in this product to ensure correct usage, to prevent danger to the user and others, and to prevent property damage. The meaning of these symbols are described below. It is important that you read these descriptions thoroughly and fully understand the contents.

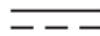
Explanation of the Symbols

SYMBOL	EXPLANATION
	Alternating current (AC): AC is an electric current in which the flow of electric charge periodically reverses direction.
	Direct current (DC): DC is the unidirectional flow or movement of electric charge carriers.
	Earth; ground: A wiring terminal intended for connection of a Protective Earthing Conductor.
	Class II equipment: The method of protection against electric shock in the case of class II equipment is either double insulation or reinforced insulation.

Viewing Certifications

Go to <http://www.zyxel.com> to view this product's documentation and certifications.

Zyxel Limited Warranty

Zyxel warrants to the original end user (purchaser) that this product is free from any defects in material or workmanship for a specific period (the Warranty Period) from the date of purchase. The Warranty Period varies by region. Check with your vendor and/or the authorized Zyxel local distributor for details about the Warranty Period of this product. During the warranty period, and upon proof of purchase, should the product have indications of failure due to faulty workmanship and/or materials, Zyxel will, at its discretion, repair or replace the defective products or components without charge for either parts or labor, and to whatever extent it shall deem necessary to restore the product or components to proper operating condition. Any replacement will consist of a new or re-manufactured functionally equivalent product of equal or higher value, and will be solely at the discretion of Zyxel. This warranty shall not apply if the product has been modified, misused, tampered with, damaged by an act of God, or subjected to abnormal working conditions.

Note

Repair or replacement, as provided under this warranty, is the exclusive remedy of the purchaser. This warranty is in lieu of all other warranties, express or implied, including any implied warranty of merchantability or fitness for a particular use or purpose. Zyxel shall in no event be held liable for indirect or consequential damages of any kind to the purchaser.

To obtain the services of this warranty, contact your vendor. You may also refer to the warranty policy for the region in which you bought the device at http://www.zyxel.com/web/support_warranty_info.php.

Registration

Register your product online to receive e-mail notices of firmware upgrades and information at www.zyxel.com for global products, or at www.us.zyxel.com for North American products.

Open Source Licenses

This product contains in part some free software distributed under GPL license terms and/or GPL like licenses. Open source licenses are provided with the firmware package. You can download the latest firmware at www.zyxel.com. To obtain the source code covered under those Licenses, please contact support@zyxel.com.tw to get it.

Index

A

- about screen [34](#)
- AC Pass-Through [6](#)
- Advanced Encryption Standard, see AES [8](#)
- AES [9, 26](#)
- AES (Advanced Encryption Standard) [8](#)
- applications [6](#)

C

- certifications [55](#)
 - viewing [57](#)
- configuration screen [30](#)
- configuration utility [8](#)
- connections overview [9](#)
- contact information [48](#)
- copyright [54](#)
- customer support [48](#)

D

- DAK [9, 26, 30](#)
- DAK (Data Access Password) [9](#)
- Data Access Key [9](#)
- Data Access Password, see DAK [9](#)
- disclaimer [54](#)

E

- electrical and cable wiring [26](#)
- electrical circuit boundaries [26](#)
- ENCRYPT Button [16](#)
- Encrypt Button [6](#)
- encryption [8, 26](#)

H

- HomePlug AV standard [6](#)

I

- installation
 - procedure [19](#)
- InstallShield wizard [23](#)
- introduction [6](#)

L

- LED [44](#)
 - ETHERNET [7](#)
 - HomePlug [7](#)
 - POWER [7](#)
- local vs. remote adapter [30](#)

M

- MAC address [30](#)
- management
 - multiple networks [10](#)
 - overview [26](#)
- managing the device
 - using the utility
- maximum PHY rate [6](#)
- multiple networks [10](#)

N

- network example [26](#)
- network information [27](#)
- Network Name [9](#)

network name [16](#)

P

pass-through [6](#)

passwords [26](#), [30](#), [31](#)

types of [9](#)

PHY Rate [6](#)

PLA Comparison [6](#)

plug-and-play [26](#)

power pass-through [6](#)

Powerline Network

Adding Devices [12](#)

Creating multiple networks [15](#)

Removing Devices [14](#)

priority settings [31](#)

application type [32](#)

priority levels [34](#)

private network [9](#)

problems and solutions [44](#)

R

receive rate [27](#)

RESET Button [17](#)

Reset Button [6](#)

RESET/ENCRYPT Button

Combination [15](#)

Manage [8](#)

Separate [16](#)

S

security [9](#), [10](#), [26](#)

passwords [9](#)

standby mode (power saving mode) [8](#)

starting the utility [27](#)

T

transfer rates [8](#)

transmit rate [27](#)

troubleshooting [44](#)

U

utility [8](#)

launching [27](#)

W

warranty [57](#)

note [58](#)

Z

ZyXEL PLA Series Configuration [26](#)