

User's Guide

PLA6457

G.hn Wave 2 Powerline Pass-through Gigabit Ethernet Adapter

Default Login Details

Default Network Name	G.hn Network
LAN IP Address	http://DHCP-assigned IP
Default Password	FLYPIG2400

Version 1.0 Ed. 1, 06/2020

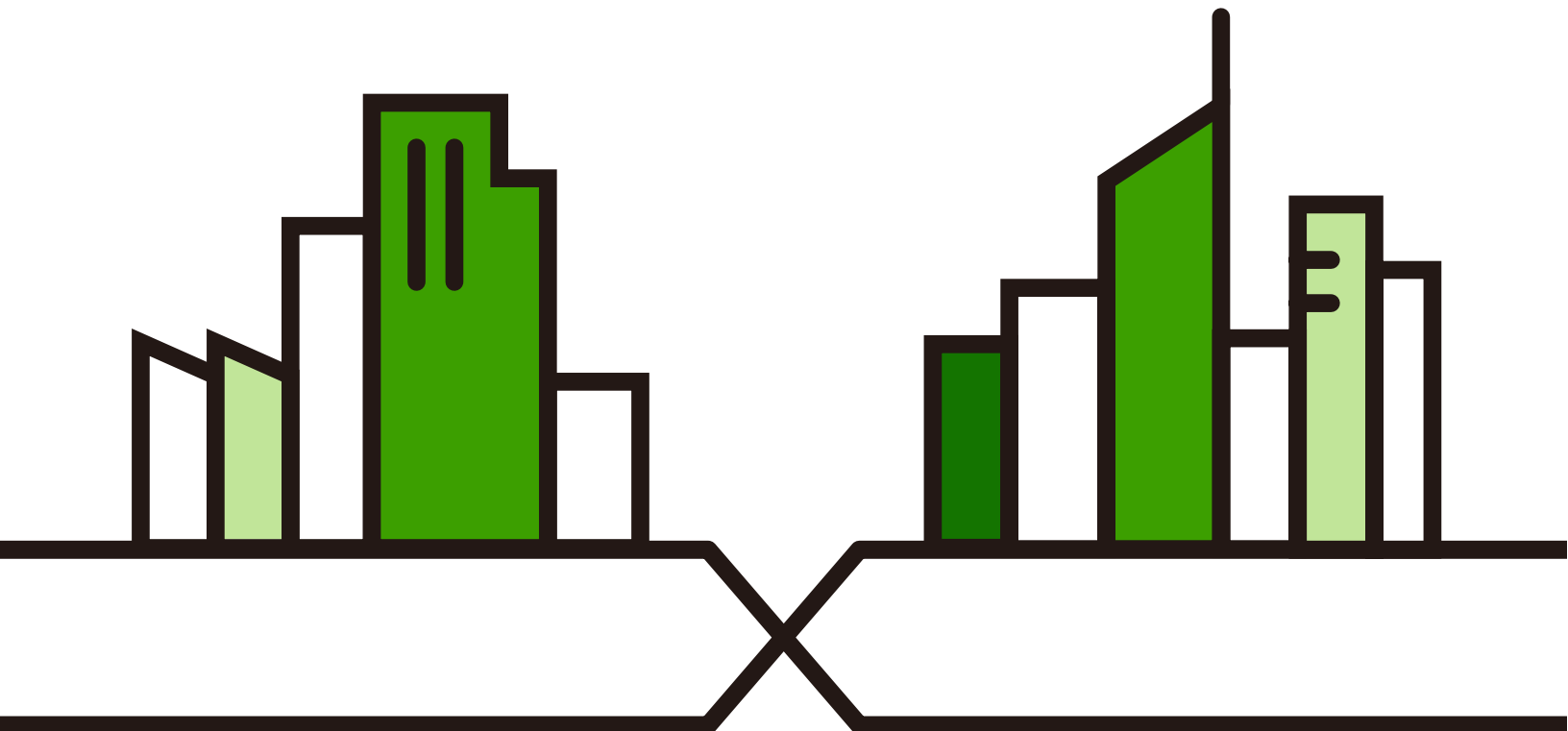

IMPORTANT!

READ CAREFULLY BEFORE USE.

KEEP THIS GUIDE FOR FUTURE REFERENCE.

Screenshots and graphics in this book may differ slightly from what you see due to differences in release versions or your computer operating system. Every effort has been made to ensure that the information in this manual is accurate.

Related Documentation

- Quick Start Guide

The Quick Start Guide shows how to connect and set up the PLA in your network.

- More Information

Go to **support.zyxel.com** to find other information on the PLA.



Document Conventions

Warnings and Notes

These are how warnings and notes are shown in this guide.

Warnings tell you about things that could harm you or your device.

Note: Notes tell you other important information (for example, other things you may need to configure or helpful tips) or recommendations.

Syntax Conventions

- The PLA6457 in this user's guide may be referred to as the "PLA" in this guide.
- Product labels, screen names, field labels and field choices are all in **bold** font.

Icons Used in Figures

Figures in this user guide may use the following generic icons. The PLA icon is not an exact representation of your device.









PLA 	Router 	Laptop Computer 
Internet 	Fax Printer 	Printer 
Desktop 	Smart TV 	Set-top Box 

Table of Contents

Document Conventions	3
Table of Contents	4
Part I: User's Guide	6
Chapter 1	
Introducing the PLA	7
1.1 Overview	7
1.1.1 G.hn Standard	8
1.2 LEDs	8
1.3 Standby Mode	9
1.4 Ways to Manage the PLA	9
1.5 Expand Your Network with the PLA	9
1.6 Security	10
1.6.1 Domain Name	10
1.6.2 Setting Up Encrypted Pairing	10
1.7 Multiple Networks	11
Chapter 2	
RESET and ENCRYPT Buttons	12
2.1 ENCRYPT Button	12
2.2 Adding Devices to a G.hn Network	12
2.3 Multiple Separate G.hn Networks	14
2.4 RESET Button	15
Part II: Technical Reference	16
Chapter 3	
Web Configurator	17
3.1 Overview	17
3.1.1 G.hn Network Security	18
3.2 System Login	18
3.3 G.hn Settings	19
3.4 IP Settings	20
3.5 Ethernet Settings	22

3.6 Device Settings	23
3.7 Multicast Settings	25
3.8 Log File Settings	27
Chapter 4	
G.hn Network Setup Tutorial	29
4.1 Overview	29
4.2 Important Terms	29
4.3 Accessing Your PLA	29
4.4 Adding a PLA	30
4.5 Setting Up a New Network with a New PLA	32
Chapter 5	
Troubleshooting.....	34
5.1 Power and Light Problems	34
5.2 Web Configurator Problems	35
5.3 Powerline Problems	36
5.4 ENCRYPT Button Problems	36
Appendix A Customer Support	38
Appendix B Legal Information	44
Index	47

PART I

User's Guide

CHAPTER 1

Introducing the PLA

1.1 Overview

This chapter introduces the main applications and features of your Zyxel G.hn Powerline adapter, which is called “PLA” in this guide.

The PLA plugs into an ordinary power outlet to easily extend a cable or DSL broadband connection or existing Ethernet (LAN) network to any other electrical outlet in any room of a house, all without the need for any new cabling. The AC power pass-through feature allows you to unplug electrical device from a power socket, plug the PLA into the socket and then plug the electrical device back into the PLA. The power plug varies depending on your region.

In the following diagram, the first PLA (PLA1) connects to an Internet gateway such as a modem and plugs into an ordinary power outlet. The second PLA (PLA2) plugs into another power outlet and connects to a computer. PLA1 and PLA2 communicates through ordinary power lines.

Figure 1 PLA Application

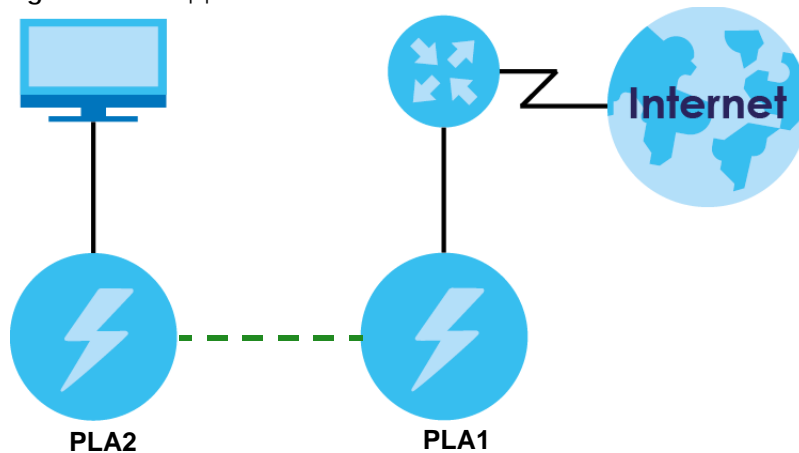

Refer to your Quick Start Guide for hardware connection information.

In this User's Guide the electrical wiring network is referred to as the “G.hn Network”.

Table 1 PLA Features

PORT/FEATURE	PLA6457
Number of Gigabit Ethernet ports	1
AC Pass-Through	✓
Encrypt Button	✓
Reset Button	✓
Maximum PHY Rate over Powerline	1200 Mbps

1.1.1 G.hn Standard

G.hn is a specification for home networking devices that operates over power lines. G.hn specifies the point-to-point security inside a domain, which means that each pair of transmitter and receiver uses a unique encryption key which is not shared by other devices in the same domain. Devices can securely communicate with each other at high data transfer rates.

The PLA uses 128-bit Advanced Encryption Standard (AES) to ensure safe transfer of information.

1.2 LEDs

The following section describes the lights (LEDs) on the PLA.

The following figure is the front panel of the PLA. Use the lights to determine if the PLA is behaving normally or if there are some problems on your G.hn Network.

Figure 2 PLA Lights

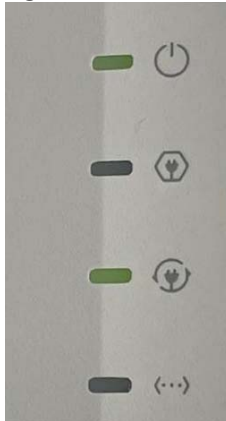

The following table describes the behavior of the lights on the PLA.

Table 2 LEDs





LIGHTS	ICON	COLOR	STATUS	DESCRIPTION
POWER		Green	On	The PLA is on and receiving power.
			Blinking	The power LED blinks when it is in standby mode that allows you to save on power during periods of inactivity. Refer to Section 1.3 on page 9 for details on this feature.
			Off	The PLA is not receiving power.
POWERLINE		Green	On	The PLA detects another PLA and can transmit and/or receive data at greater than 80 Mbps.
		Amber		The PLA detects another PLA and can transmit and/or receive data between 20 – 80 Mbps.
		Red		The PLA detects another PLA and can transmit and/or receive data between 0 – 20 Mbps.
		Green/ Amber/ Red	Blinking	The PLA is communicating with another PLA. Data is being transmitted and/or received.
			Off	The PLA does not detect another PLA.

Table 2 LEDs (continued)

LIGHTS	ICON	COLOR	STATUS	DESCRIPTION
ENCRYPTED PAIRING		Green	On	It indicates the PLA is connected to another device in encrypted pairing mode. The transmitter and receiver uses a unique encryption key for point-to-point security.
			Blinking	It indicates the PLA is trying to connect with another device in encrypted pairing mode.
			Off	Encrypted pairing mode is disabled.
ETHERNET		Green	On	The 10/100/1000 Mbps Ethernet connection is up.
			Blinking	The PLA is communicating with a networking device connected to it.
			Off	The PLA does not detect any devices connected to its ETHERNET port.

1.3 Standby Mode

You can set your PLA to save on power when there is no Ethernet connection or activity. Use the Web Configurator's **Ethernet** screen to set the period of time when the PLA will go into standby mode. Refer to [Section 3.5 on page 22](#) for details on this feature.

The PLA's power LED blinks signaling that it is going into standby mode. The Ethernet LED, Encrypted Pairing LED, and Powerline LED are turned off in standby mode.

Note: While in standby mode, you cannot use the **RESET** and **ENCRYPT** buttons. To enable the **RESET** and **ENCRYPT** buttons again, you have to connect the PLA's Ethernet cable to a computer/notebook or modem/router first. The PLA wakes up from standby mode and you can start using the **RESET** and **ENCRYPT** buttons.

1.4 Ways to Manage the PLA

Use the **ENCRYPT** button to add PLAs to your G.hn Network. See [Chapter 2 on page 12](#) for instructions on using the ENCRYPT feature.

Use the Web Configurator to manage the PLA. See [Chapter 3 on page 19](#) for instructions on using the Web Configurator.

1.5 Expand Your Network with the PLA

Your network can be further expanded by plugging additional PLAs into other outlets in your home and connecting other computers or network devices (for example, a Smart TV) to them.

Figure 3 Expand Your Network with the PLA

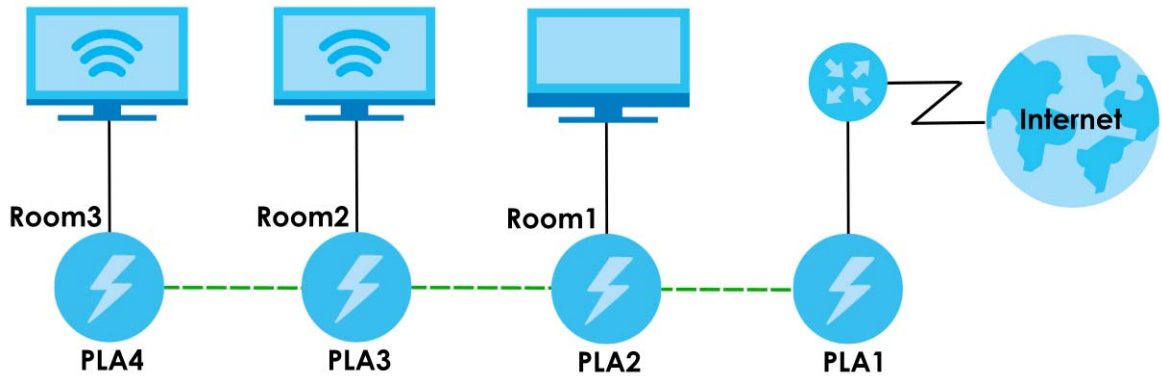

Connect your first PLA (PLA1) to an Internet gateway such as a modem and plug it into an ordinary power outlet in your home. Plug a second PLA (PLA2) in Room1 into another power outlet and connect a computer to the PLA for Internet access. Plug a third PLA (PLA3) in Room2 into another power outlet and connect a Smart TV to the PLA for streaming video. Plug a fourth PLA (PLA4) in Room3 into another power outlet and connect a Smart TV to the PLA for streaming video.

1.6 Security

Since your G.hn Network may extend outside your premises, it is important to set up security on your PLA.

1.6.1 Domain Name

You can use the domain name to identify your PLA in the G.hn Network.

Table 3 Domain Name Summary

IDENTITY	DESCRIPTION
Domain Name	Your PLA follow the G.hn standard and is shipped with the same domain name "G.hn Network". Change the domain name through the Web Configurator or RESET button to create a private network. See Section 3.4 on page 20 .

1.6.2 Setting Up Encrypted Pairing

The ENCRYPT feature automatically sets up encrypted pairing on your G.hn Network using the **ENCRYPT** button (see [Section 2.1 on page 12](#) for more information). It involves authenticating the identity of the two PLAs to be paired and encrypting the link.

Alternatively, use the Web Configurator to set up encrypted pairing on the PLA. Although the PLA is a "plug-and-play" network expanding solution there are several reasons for enabling security on the G.hn Network in your home.

- 1 It is easy and only requires you to change a network name.

- 2 It is a good idea to ensure privacy of your communication. When you use the PLA and other PLAs, the electrical wiring in your home becomes an extension of your Ethernet network. Your network traffic flows freely within the electrical circuit of your home and is bounded in most cases by a power meter.

Without encrypted pairing (security) your information is accessible to anyone using a PLA on the same electrical circuit. In some cases, a circuit can be shared by more than one household.

To prevent compromising your network security, you can create a private network. A private network uses a **Domain Name** to make sure that only permitted PLAs can communicate in your network. See [Section 3.4 on page 20](#) for information on setting up a private network.

- 3 You may need to change the **Domain Name** to create multiple G.hn Network. See the next section for more information on how to set up a multiple network.

1.7 Multiple Networks

Multiple G.hn Networks can coexist on a single electrical circuit. You might want to implement multiple G.hn Networks in a small office environment where you have two independent Ethernet networks.

- 1 Connect one PLA to a router or switch on the first Ethernet network and assign a **Domain Name** (for example "Tom's Network") to this PLA (see [Section 3.3 on page 19](#) for more information). Add additional PLAs to your network by plugging them into your Powerline outlets and assigning them "Tom's Network". This completes the configuration of your first G.hn Network.
- 2 Connect another PLA to a router or switch on the second Ethernet network and assign a different **Domain Name** (for example "Alice's Network") to this PLA. Again, add additional PLAs and assign them "Alice's Network".

You now have two private networks on your Powerline circuit. Information is not shared between the two networks as only PLAs with the same criteria for this **Domain Name** can communicate with each other.

CHAPTER 2



RESET and ENCRYPT Buttons

2.1 ENCRYPT Button

The **ENCRYPT** button allows you to set up a secure Powerline connection with other G.hn compliant PLAs which also support the ENCRYPT feature. No other Powerline setting changes are required to connect.

The following table summarizes the actions that occur when the **ENCRYPT** button is pressed for specific lengths of time.

Table 4 ENCRYPT

TIME	ACTION	ENCRYPTED PAIRING LIGHT BEHAVIOR	POWERLINE LIGHT BEHAVIOR
2 to 5 seconds	Join an existing G.hn Network by sharing the same network name as other devices on the network.	The Encrypted Pairing () light blinks until the device is connected. This may take a minute.	The Powerline () light turns on if your device is connected to another PLA or a G.hn Network.

Note: The domain name is unknown when you use the **ENCRYPT** button.

2.2 Adding Devices to a G.hn Network

You can connect a number of PLAs on a G.hn Network, but you can use the **ENCRYPT** button on only two PLAs at a time.

Place a PLA close to another PLA so you have time to set up each one. After you set up the first PLA, you have 120 seconds to set up the second PLA.

Note: Your PLA must be connected to a networking equipment for the **ENCRYPT** button to work. Refer to [Section 1.3 on page 9](#) for more details.

Follow the steps below to set up your G.hn Network:

- 1 Press the **ENCRYPT** button at the side of your PLA for 2 to 5 seconds. The encrypted pairing () light will blink as the PLA tries to set up a connection with a new random domain name.

Figure 4 ENCRYPT Connection Procedure



Note: Check the lights on the two PLAs. The encrypted pairing (🔌) and Powerline (🔌) lights should be on while the devices are connecting. Wait for about 2 minutes while your PLAs connect.

If the encrypted pairing (🔌) light does not blink when you press ENCRYPT, you have probably pressed the ENCRYPT button for too long. Try pressing the ENCRYPT button again for 2 to 5 seconds.

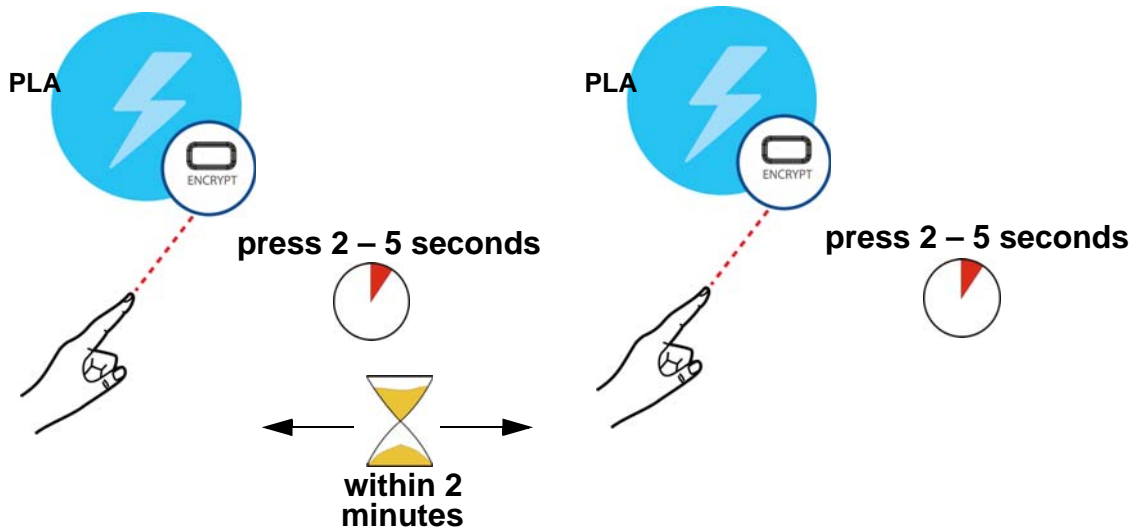
If the Powerline (🔌) lights on both PLAs do not light up, the PLAs are not connected. Repeat step 1 in this section. If that does not work, see Troubleshooting in Section 5.4 on page 36 for suggestions.

- 2 To add more PLAs to your network, use any PLA (A or B) you have connected to set up a connection with the PLAs you want to connect (C and D).
- 3 Press the **ENCRYPT** button on both PLAs (A and C, or B and C) for 2 to 5 seconds to add PLA C. This must be done within 2 minutes (120 seconds) of pressing the **ENCRYPT** button on the PLA.
- 4 Press the **ENCRYPT** button on both PLAs (A and D, B and D, or C and D) for 2 to 5 seconds to add PLA D. This must be done within 2 minutes (120 seconds) of pressing the **ENCRYPT** button on the PLA.
- 5 After pairing them, unplug the PLAs and plug them where you want to extend your network.

Figure 5 Adding More PLAs to Your Network

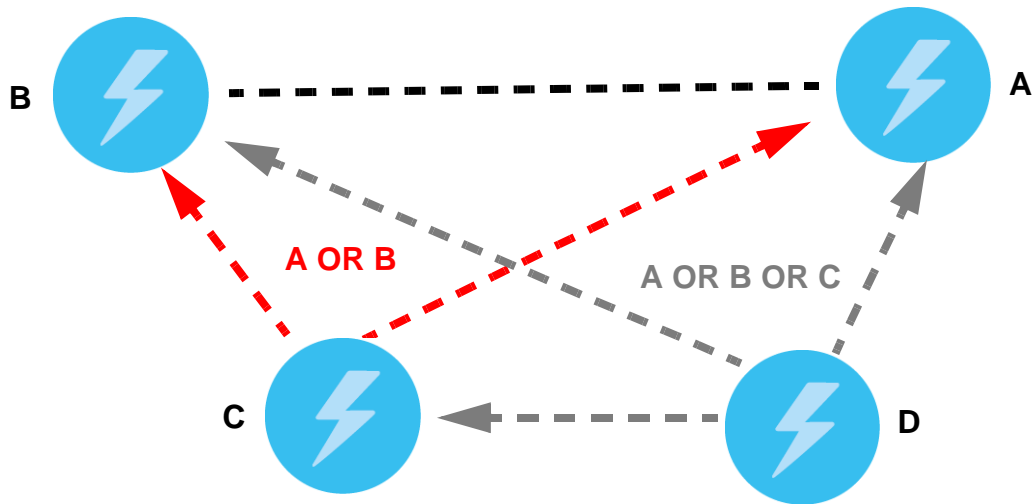

This sets up your G.hn Network between your PLAs.

2.3 Multiple Separate G.hn Networks

You can use the **ENCRYPT** button to create multiple separate G.hn Networks by using the **ENCRYPT** button on different pairs of PLAs.

- 1 Press the **ENCRYPT** button on PLAs **E** and **F** for 2 to 5 seconds. This must be done within 2 minutes (120 seconds) of pressing the **ENCRYPT** button on the first PLA.
- 2 Wait for about one minute while PLAs **E** and **F** connect.
- 3 Now pair two different PLAs. Press the **ENCRYPT** button on PLAs **G** and **H** for 2 to 5 seconds and within 2 minutes of each other.
- 4 Wait for about one minute while PLAs **G** and **H** connect.
- 5 When the encrypted pairing (🔌) and Powerline (🔌) lights shine steadily, the devices are connected.

Figure 6 Two Separate G.hn Networks

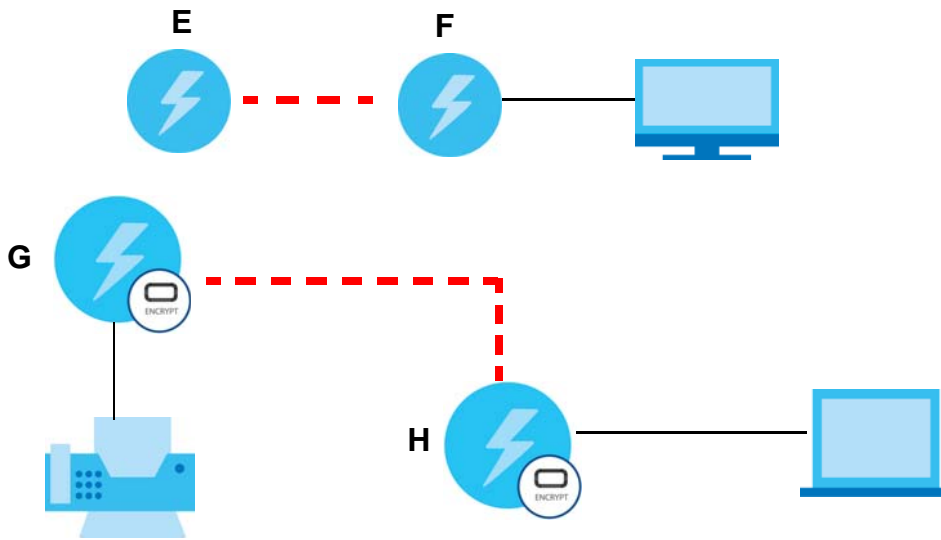

If the Powerline (⚡) lights on both PLAs do not light up, the PLAs are not connected. Repeat the connection process, making certain you press the **ENCRYPT** buttons for the correct time and within 2 minutes of each other. If that does not work see Section 5.4 on page 36 for suggestions.

See Troubleshooting in [Chapter 5 on page 36](#) for suggestions on problems with the **ENCRYPT** button and the lights.

2.4 RESET Button

The **RESET** button allows you to reset the PLA to the factory defaults. It also unpairs the PLA from a network.

The following table summarizes the actions that occur when the **RESET** button is pressed for specific lengths of time.

Table 5 **RESET**

TIME	ACTION	POWER LIGHT BEHAVIOR	POWERLINE LIGHT BEHAVIOR
10 to 15 seconds	Clear all user-entered configuration information and return the device to its factory defaults.	The power (⏻) light blinks and then shines steadily.	The Powerline (⚡) light turns off when it disconnects from the G.hn Network.

Note: The domain name is unknown when you use the **RESET** button. You can then pair the PLA to a different network.

See Troubleshooting in [Chapter 5 on page 36](#) for suggestions on problems with the **ENCRYPT** button and the lights.

PART II

Technical Reference

CHAPTER 3

Web Configurator

3.1 Overview

This chapter shows you how to use the Web Configurator to secure and manage on your G.hn network.

The Web Configurator is an HTML-based management interface that allows easy PLA setup and management through Internet browser. Use a browser that supports HTML5, such as:

- Microsoft Edge
- Internet Explorer 11 or later
- Google Chrome 34.0.1847.131 or later
- Mozilla Firefox 29.0.1 or later
- Opera 21.0 or later
- Safari 5.1.7 or later

The recommended minimum screen resolution is 1024 by 768 pixels. In order to use the Web Configurator you need to allow:

- Web browser pop-up windows from your device. Web pop-up blocking is enabled by default in some browsers.
- JavaScript (enabled by default).
- Java permissions (enabled by default).

The PLA is designed as a plug-and-play network expanding solution. This means that once you complete your hardware connections, the PLAs in your network (without additional configuration) are able to communicate with each other by sending and receiving information over your home's electrical wiring (**A**).

Figure 7 Example Network Setup

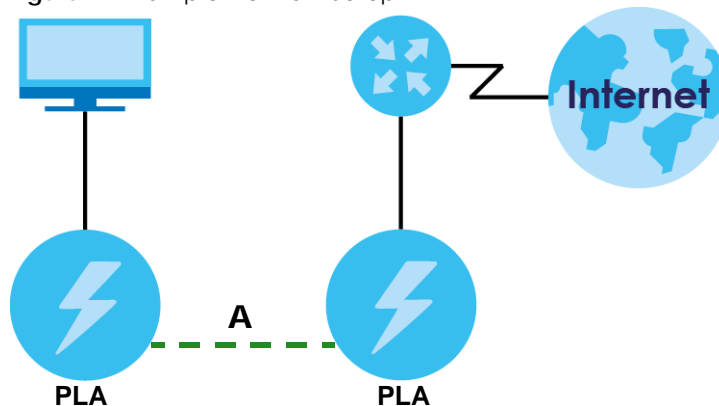

All G.hn compliant PLAs within range can join your network. The range varies depending on the quality of your home's wiring.

See [Section 3.1.1 on page 18](#) for more information on enhancing your G.hn network security.

3.1.1 G.hn Network Security

When the PLAs communicate with each other, they use encryption to protect the information that is sent in the G.hn network. Encryption is like a secret code. If you do not know the secret code, you cannot understand the message. The G.hn standard uses 128-bit AES (Advanced Encryption Standard) to safely transmit data between PLAs.

For the PLAs to communicate with each other they all need to use the same network name (or **Domain Name**). This network name allows the PLAs to understand the encrypted information sent in the G.hn network.

By default the PLAs are all configured with the network name G.hn, this allows you to simply plug the devices in and not worry about setting up security. If you want to enhance the security on your G.hn network, you can change the network name on the PLAs you want to allow to communicate in your G.hn network.

3.2 System Login

- 1 Make sure your PLA hardware is properly connected to a router with DHCP server (refer to the Quick Start Guide). Note down the DHCP-assigned IP address for your PLA.
- 2 Start your web browser.
- 3 The PLA is a DHCP client by default. Type "http://DHCP-assigned IP address" in the **Location** or **Address** field. Press [ENTER]. Your computer must be in the same subnet in order to access this website address.
- 4 The following screen appears.

Figure 8 Web Configurator: Login



ZYXEL
Your Networking Ally

PLA6457 Web Configuration

Authentication

This unit is password protected. Please enter the correct password to access the web pages

•Password

Ok Cancel

- 5 Enter the default password as shown on the cover page. Click **Ok** to log into the Web Configurator to manage the PLA directly.

3.3 G.hn Settings

Your PLA conforms to the G.hn (G.hn) standard for sending data over electrical power wiring in your home. Use the **G.hn** screen to change the basic settings of the PLA. Click **G.hn** to access this screen.

Figure 9 G.hn Screen

The following table describes the labels in this screen.

Table 6 G.hn Screen

LABEL	DESCRIPTION
Basic Settings	
MAC address	This field displays the MAC address of your PLA. The MAC address of your PLA can be found by looking at the label on your device. It consists of six pairs of hexadecimal characters (hexadecimal characters are "0 – 9" and "a – f"). In the case of the PLA, this label is on the back of the device.
Device ID	<p>Every PLA acts as the DOMAIN_MASTER by default before connecting to another PLA. The default Device ID is 1.</p> <p>After you press the ENCRYPT button to connect your PLA to another PLA, the two PLAs will determine which one acts as the DOMAIN_MASTER. This field displays 1 when your PLA is the DOMAIN_MASTER. It displays 2 when your PLA is the END_POINT (see the Force node Type field in this table for more information).</p> <p>Note: When none of the PLA works as the DOMAIN_MASTER in the network, you can manually configure your PLA as the END_POINT by selecting END_POINT in the Force node Type field. The Device ID will be set to 0.</p>

Table 6 G.hn Screen (continued)

LABEL	DESCRIPTION
Domain Name	<p>The default domain name of the PLA is "G.hn Network". The PLAs use the same domain name to recognize and communicate with each other over the powerline network. If you change the domain name of one device on the network, it will no longer be recognized as part of that network.</p> <p>If you change the domain name, make sure you change the domain name for all of the PLAs that you want to be part of your powerline network.</p> <p>The domain name can be from 8 to 64 characters in length, using "A"–"Z", "a"–"z", "0"–"9"; spaces are not allowed.</p>
Force node Type	<p>This field forces the PLA to have a particular role (END_POINT or DOMAIN_MASTER).</p> <ul style="list-style-type: none"> • Select DOMAIN_MASTER if your PLA connects to a router or AP. • Select END_POINT if your PLA connects to the end device (for example, computer). • It is recommended to select the default setting AUTOMATIC for automatic role detection of the PLA.
Node type	<p>Shows the current role of the device based on your selection in the previous field.</p> <p>Note: Node type change can take some time, click Ok after making any changes in the Force node Type field. You may need to refresh your webpage.</p>
G.hn profile	<p>This field selects the G.hn profile of all PLAs to apply in the G.hn network (PLC 100 MHz MIMO Boost, PLC 100 MHz Boost).</p> <ul style="list-style-type: none"> • Select PLC 100 MHz MIMO Boost (multiple input multiple output) when the PLA connects to a 3-prong electrical socket in your home. Multiple electrical paths between PLAs in the same G.hn network are available and sending and receiving of data is through all 3 wires (power, neutral, and ground). • Select PLC 100 MHz Boost when the PLA connects to a 2-wire electrical socket. A single electrical path between PLAs in the same G.hn network is available and sending and receiving of data is through the 2 wires (power and neutral).
Encryption Configuration	
Encryption is ENABLED	
Pairing password	Use this password for authentication. Enter a custom password to manually create a secure connection with another PLA. The password can be up to 30 alphanumeric and special characters. Then click Change .
Automatic configuration	Before connecting, make sure the other PLA is using the same Pairing password . Then click Pair to allow connection with another PLA in the same power circuit. Wait a few minutes for the connection, you may need to refresh your webpage to update the status.
Available Connections	This field list all the available G.hn connection details (remote node Device ID , MAC address , Phy Tx (Mbps) transmission and Phy Rx (Mbps) reception physical speeds. Phy Tx (Mbps) refers to how fast information is sent from the selected PLA to this PLA. Phy Rx (Mbps) refers to how fast information is received from the selected PLA to this PLA.

3.4 IP Settings

Use the **IP** screen to enable DHCP, or manually assign an IPv4 or IPv6 address, subnet mask, default gateway, and DNS server to the PLA.

Figure 10 IP Screen

The following table describes the labels in this screen.

Table 7 Configuration Screen

LABEL	DESCRIPTION
IPv4 configuration	
DHCP enabled	Select YES if your PLA is connected to a DHCP-enabled router that can assign it an IPv4 address. The IPv4 address / netmask , Default Gateway , and DNS fields will be filled automatically when configuration is received from the DHCPv4 server. Select NO if you wish to assign an IPv4 Address, Subnet Mask, Default Gateway and DNS to your PLA.
IPv4 address / netmask	Enter the IPv4 address and subnet mask you wish to assign to your PLA. This field is only available when you select No in the DHCP enabled field.
Default Gateway	Enter the gateway IP address you wish to assign to your PLA. This field is only available when you select No in the DHCP enabled field.
DNS	Enter the IPv4 DNS server address you configure manually. This field is only available when you select No in the DHCP enabled field.
Click Ok for the changes to take effect.	
Note: All changes except the DNS server will only take effect after a system reboot.	
IPv6 configuration	
DHCP enabled	Select YES if your PLA is connected to a DHCP-enabled router that can assign it an IPv6 address. The IPv6 address / prefix , Default Gateway , and DNS fields will be filled automatically when configuration is received from the DHCPv6 server. Select NO if you wish to assign an IPv4 Address, Subnet Mask, Default Gateway and DNS to your PLA.

Table 7 Configuration Screen (continued)

LABEL	DESCRIPTION
IPv6 address / prefix	Enter the IPv6 address you wish to assign to your PLA and the address prefix length to specify how many most significant bits in an IPv6 address compose the network address. This field is only available when you select No in the DHCP enabled field.
Default Gateway	Enter the IP address of the next-hop gateway. The gateway is a router connected to your PLA. The gateway helps forward packets to their destinations. This field is only available when you select No in the DHCP enabled field.
DNS	Enter the IPv6 DNS server address you configure manually. This field is only available when you select No in the DHCP enabled field.
IPv6 link-local address	This field displays the IPv6 link-local address and the network prefix that the PLA generates itself for the interface.
IPv6 SLAAC address	This field displays the IPv6 SLAAC (Stateless Address Auto-configuration) IP address and prefix obtained from an IPv6 router in the network.
Click Ok for the changes to take effect.	
Note: All changes except the DNS server will only take effect after a system reboot.	

3.5 Ethernet Settings

Use the **Ethernet** screen to view information on the PLA's Ethernet port, as well as set the PLA's power saving mode.

Figure 11 Ethernet Screen

ZYXEL
Your Networking Ally

PLA6457 Web Configuration Log Out

[G.hn](#)
[IP](#)
[Ethernet](#)
[Device](#)
[Multicast](#)
[Log file](#)

Ethernet

External Interfaces:

Interface	Speed	Duplex	Interface Type	Mode	Internal PHY	Link
ETHA	100	FULL_DUPLEX	RGMII	MAC	NO	NO
ETHB	1000	FULL_DUPLEX	SGMII	MAC	NO	YES

Powersaving

•Inactivity detection mode ETH link

•Inactivity time(s)

The following table describes the labels in this screen.

Table 8 Ethernet Screen

LABEL	DESCRIPTION
Ethernet	
External Interfaces	
Interface	This shows ETHA and ETHB (PLA's Ethernet port).
Speed	This shows a link rate of 100 Mbps for ETHA, and a link rate of 1000 Mbps for ETHB.

Table 8 Ethernet Screen (continued)

LABEL	DESCRIPTION
Duplex	This shows the duplex setting (Full or Half). Half duplex cannot send and receive at the same time. Full duplex can send and receive at the same time.
Interface Type	MII (Media Independent Interface) is the interface between the media access control (MAC) and the PLA. RGMII (Reduced Gigabit Media Independent Interface) is displayed for the PLA that connects to a device requiring Internet over Powerline, such as a computer. SGMII (Serial Gigabit Media Independent Interface) is displayed for the PLA that connects to a device for Internet access, such as a router.
Mode	This shows MAC.
Internal PHY	This is the Ethernet's internal physical layer and will always show No .
Link	This shows YES when the PLA has an active connection with a router or computer. Otherwise, it will show No .
Powersaving	
Inactivity detection mode	Select ETH link to have the selected PLAs go into standby mode when there is no Ethernet connection. Select ETH activity to have the selected PLAs go into standby mode when there is no Ethernet activity detected. Otherwise, select Disabled to have the PLAs never go into standby mode. The default setting is Disabled .
Inactivity time(s)	Set the period of time (5 to 86,400 seconds) when the PLA will go into standby mode when no Ethernet connection or activity is detected (based on your selection in the Inactivity detection mode field). This field is not available if you select Disabled in the Inactivity detection mode field.

3.6 Device Settings

Use the **Device** screen to view basic system information of the PLA. You can also change the password for accessing the Web Configurator.

This screen also lets you upload new firmware to your PLA. You can download new firmware releases from your nearest Zyxel FTP site (or www.zyxel.com) to upgrade your device's performance. The upload process uses HTTP (Hypertext Transfer Protocol) and may take up to 2 minutes. After a successful upload, the PLA will reset.

Figure 12 Device Screen

ZYXEL
Your Networking Ally

PLA6457 Web Configuration Log Out

[G.hn](#)
[IP](#)
[Ethernet](#)
[Device](#)
[Multicast](#)
[Log file](#)

Hardware information

- Device name: PLA6457
- Device description: G.hn 2400 Mbps Pass-thru Powline Adapter
- Device manufacturer: Zyxel Networks
- Serial number: 20A9083XXXF-BE000090
- MAC address: 1c:64:99:c4:cd:6b
- HW version: 3_0

Software information

- FW version: V1.00 (ACAJ.0)B1
- System uptime: 0 days, 0h 43m 33s

Security

- New Configuration password:

HTTP SW update

- Upgrade file:

The following table describes the labels in this screen. After you see the firmware updating screen, wait 2 minutes before logging into the PLA again.

Table 9 Device Screen

LABEL	DESCRIPTION
Hardware information	
Device name	This field displays the PLA system name. It is used for identification.
Device description	This field shows that this is a G.hn bridge PLA.
Device manufacturer	This field displays the manufacturer of this PLA.
Serial number	This field displays the manufacturer assigned number of this PLA.
MAC address	This field displays the Ethernet adapter MAC (Media Access Control) address of this PLA.
HW version	This field displays the hardware version number of this PLA.
Software information	
FW version	This field displays the current version of the firmware inside this PLA.
System uptime	This field displays how long the PLA has been running since it last started up. The PLA starts up when you plug it in, or when you reset it.
Security	
New Configuration password	Type your new Web Configurator password. The password must consist of 6 to 64 characters, including 0 to 9 and a to z (case sensitive). Note that as you type a password, the screen displays a (*) for each character you type. Then click OK . After you change the password, use the new password to access the PLA.
HTTP SW update	

Table 9 Device Screen (continued)

LABEL	DESCRIPTION
Upgrade file	Type the location of the file you want to upload in this field or click Browse to find it. Note: Only use firmware for your PLA. Do NOT remove power from the PLA while firmware upload is in progress!
Browse	Click this to find the .bin file you want to upload. Remember that you must decompress compressed (.zip) files before you can upload them. Click OK to begin the upload process. This process may take up to 2 minutes. When the Download Progress bar reaches 100 % , click Hardware Reset .

Note: The PLA will reset and the Web Configurator will refresh to the **Login** screen upon successful installation. It is recommended that you compare the software version shown on the Web Configurator's **Device** page **FW version** field with the firmware version installed, to confirm if the installation is successful.

3.7 Multicast Settings

Multicast delivers IP packets to members defined by multicast groups. Membership to these multicast groups are established using IGMP/MLD.

Internet Group Multicast Protocol (IGMP) is an IPv4 network-layer protocol used to establish membership in a Multicast group – it is not used to carry user data.

Multicast Listener Discovery (MLD) is an IPv6 network-layer protocol that uses ICMPv6 message types, rather than IGMP message types. MLDv1 is equivalent to IGMPv2 and MLDv2 is equivalent to IGMPv3.

Use the **Multicast** screen to configure IGMP/MLD settings.

Figure 13 Multicast Screen

ZYXEL
Your Networking Ally

PLA6457 Web Configuration Log Out

[G.hn](#)
[IP](#)
[Ethernet](#)
[Device](#)
[Multicast](#)
[Log file](#)

Multicast Configuration*

- IGMP Snooping YES ▾
- MLD snooping YES ▾
- IGMP/MLD broadcast report NO ▾
- IGMP/MLD broadcast report mode 0 ▾
- Filter unknown multicast traffic NO ▾
- IGMP Multicast ranges:

Minimum IP address			Maximum IP address		
224	0	.0.0	239	254	.255.255
0	0	.0.0	0	0	.255.255
0	0	.0.0	0	0	.255.255
0	0	.0.0	0	0	.255.255

Ok Cancel

Broadcast suppression

- Broadcast xput limit (Mbps) 2

Ok Cancel

The following table describes the labels in this screen.

Table 10 Multicast Screen

LABEL	DESCRIPTION
Multicast Configuration	
IGMP Snooping	Select YES to allow the PLA to learn multicast group. Otherwise, select NO to disable it.
MLD Snooping	Select YES to allow the PLA to discover the presence of MLD (Multicast Listener Discovery) members who wish to receive multicast packets. Otherwise, select NO to disable it.
IGMP/MLD broadcast report	This field is only available when IGMP Snooping is YES . Select NO to drop IGMP/MLD reports until a multicast member is discovered. Then the reports are sent to the member. Select YES to have the PLA send IGMP/MLD reports according to the next field.
IGMP/MLD broadcast report mode	This field is only available when IGMP/MLD broadcast report is YES . <ul style="list-style-type: none"> • Select 0 to allow the PLA to send IGMP/MLD reports even when the video source is unknown. • Select 1 to allow the PLA to always send IGMP/MLD reports. • Select 2 to allow the PLA to send IGMPv3 IGMP/MLD reports even when the video source is unknown.
Filter unknown multicast traffic	Select YES to allow the PLA to listen to multicast traffic on networks defined by multicast groups only. Otherwise, select NO to disable it.
IGMP Multicast ranges	Up to 4 multicast IP address ranges can be configured defining the minimum and maximum IP addresses of each range. Only multicast traffic within these ranges will be processed by the PLA. This field is only available when IGMP Snooping is NO .
Click Ok for the changes to take effect.	

Table 10 Multicast Screen (continued)

LABEL	DESCRIPTION
Broadcast suppression	
Broadcast xput limit (Mbps)	Broadcast suppression prevents the Ethernet port from being overloaded by a broadcast storm. In Broadcast xput limit , set the maximum throughput allowed before suppressing broadcast traffic. 0 disables broadcast suppression.
Click Ok for the changes to take effect.	

Upon clicking **Ok** for **Broadcast suppression**, reboot your PLA by clicking **Hardware Reset** to make the changes when the next screen appears.

Figure 14 Hardware Reset

Note: Do NOT click **Ok** for **Factory Reset**.

3.8 Log File Settings

Use the **Log file** screen to allow your PLA to send event logs to an FTP server. You can set the data capture time interval as well as how often it uploads to the FTP server.

Figure 15 Log File Screen

The following table describes the labels in this screen.

Table 11 Log file Screen

LABEL	DESCRIPTION
Log File Configuration	
Enable Log File	Select YES to allow your PLA to send event logs to an FTP server. Otherwise, select NO to disable it.

Table 11 Log file Screen (continued)

LABEL	DESCRIPTION
Data capture interval(s)	This field allows you to set the time interval (1 – 9,999,999 seconds) to capture data.
FTP server URL	This field allows you to set the web address of the remote FTP server where the files (logs) will be uploaded.
FTP server login	This field allows you to set the name for logging in to the FTP server. The login name must contain 1 to 30 characters, including 0 to 9, a to z, and !@#%*()-_+=~.,{}[]\.
FTP server password	This field allows you to set the password for logging in to the FTP server. The login password must contain 1 to 30 characters, including 0 to 9, a to z, and !@#%*()-_+=~.,{}[]\.
Upload to server interval (min)	This field allows you to set the time interval (1 – 9,999,999 minutes) to send the captured data to the remote server. Enter 0 to disable this function.

CHAPTER 4

G.hn Network Setup Tutorial

4.1 Overview

Use this tutorial to expand your existing G.hn network.

After setting up your first home network (instructions for that are in the Quick Start Guide for your Zyxel PLA) you may want to extend the network or create a new one by adding additional PLAs. This tutorial shows you the following.

- How to start up your new PLA. You need to do this before you can begin the next sections.
- How to make your existing G.hn network bigger by adding new PLAs.
- How to make a new network separate from your existing network with new PLAs.

The tutorial uses the Web Configurator to set up your PLA.

Note: The PLA in this tutorial is an example only. Your PLA may be different.

4.2 Important Terms

Domain Name	The domain name allows a PLA to connect with other PLAs that have the same domain name. It provides security for your G.hn network. The domain name uses English letters or numbers, from 8 to 64 characters long, with no spaces allowed. (See Section 3.3 on page 19 for more information.)
-------------	---

4.3 Accessing Your PLA

- 1 Plug the PLA you want to add to your network into a power socket and, if needed, switch the power socket on.

Figure 16 Plug Your PLA into a Power Socket

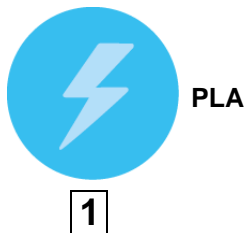

- 2 Connect the PLA to your computer.

- 3 Use a LAN or Ethernet cable (shown below) to connect the LAN or Ethernet port on your adapter to the same kind of port on your computer.

Figure 17 Connect Your PLA to a Computer

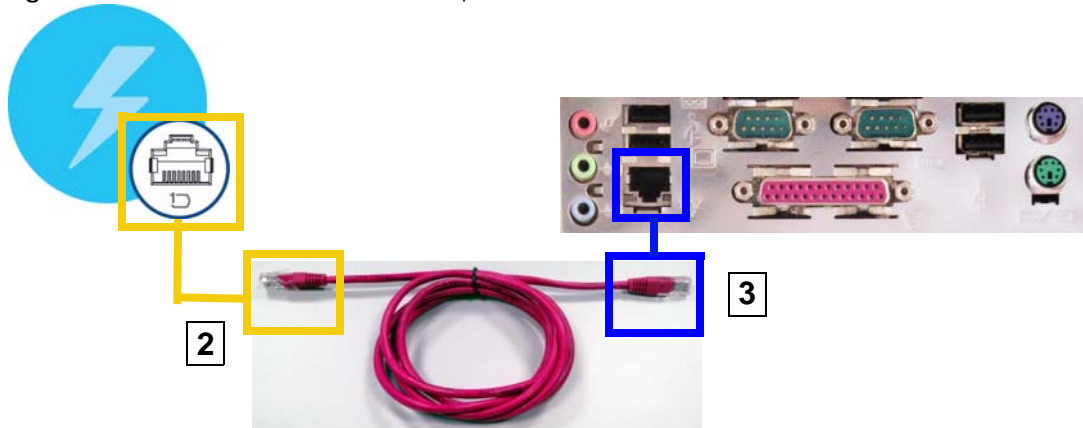

- 4 Open the Web Configurator on your computer. See [Section 3.2 on page 18](#) for how to launch the Web Configurator.
- 5 You are now ready to extend your G.hn network or set up a second network.
 - See [Section 4.4 on page 30](#) to add a new PLA to your network.
 - See [Section 4.5 on page 32](#) to set up a second network with your new adapters.

4.4 Adding a PLA

This section shows you how to add a new PLA to expand your existing network.

The figure below shows the family computer with Internet access on a G.hn network. Expand the network by adding a new PLA connected to a printer.

Figure 18 Add a Printer to Your G.hn Network

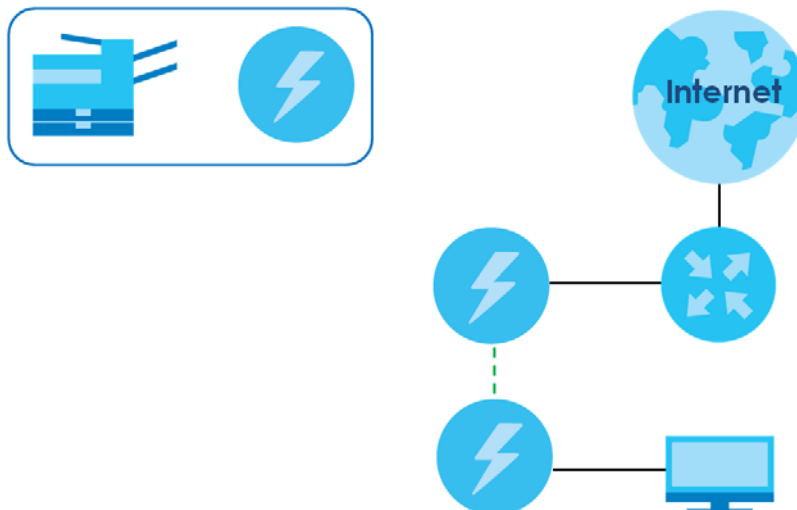

Note: You do not need to know the domain name of the new adapter to add it to your network.

- 1 Connect your computer to the PLA you want to add to your network and open the Web Configurator (see [Section 4.3 on page 29](#)).
- 2 Go to the **G.hn** screen. On this screen in the **Device ID** field your new PLA should appear as **1 (A)**. Check the **Device ID 1** adapter's **MAC address (B)**. It should match the MAC address listed on the label on the back of your PLA.

Figure 19 Adding a New Adapter

- 3 Type the password for your existing network in the **Pairing password** field (C). Then click **PAIR (D)**.
- 4 Your new adapter will now have the same **Domain Name** as your existing network and so has now joined your existing network.
- 5 Connect the adapter's Ethernet port to the device's LAN port to add the device to the network, for example, your Internet refrigerator in the kitchen.
- 6 Plug the adapter into a power outlet.
- 7 Repeat this procedure for all additional PLAs that you want to add to your existing or new G.hn network.

4.5 Setting Up a New Network with a New PLA

This section shows you how to use your new PLAs to set up a new G.hn network separate to your existing network.

The figure below shows two G.hn networks in a house. The first network (1) shows the home computer connected to a printer and access to the Internet. The second network (2) has no Internet access but with a media adapter such as the Zyxel DMA-1100P you can use your TV to watch movies and play games which are stored on a computer.

Figure 20 Add New Adapters to Make a Second Network

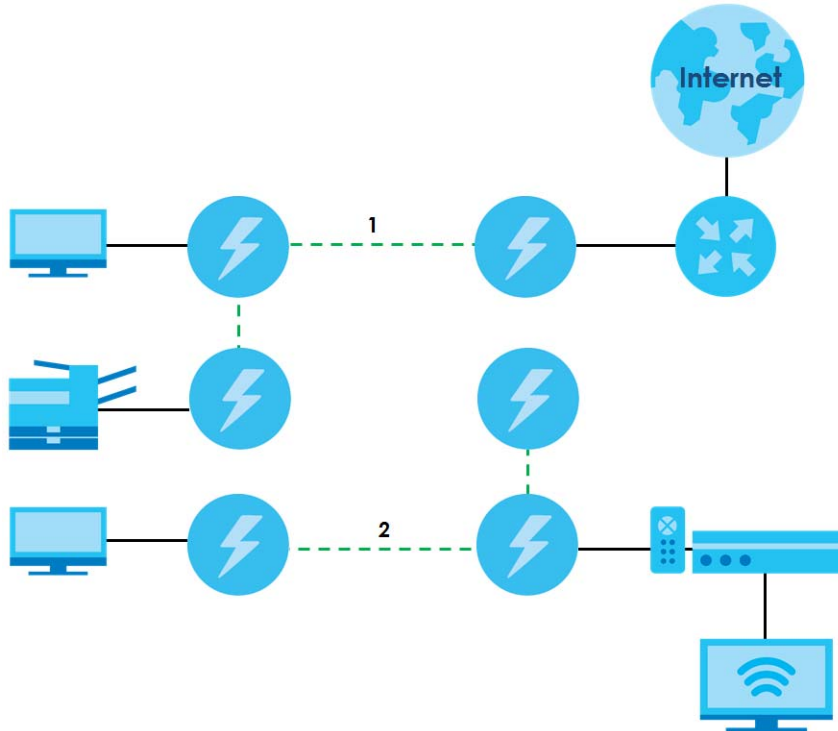

- 1 Connect your new PLA and open the Web Configurator as shown in [Section 4.5 on page 32](#). The screen shown below appears.
- 2 Type a **Domain Name** that is different from the **Domain Name** for your existing network. Make sure you use the same new **Domain Name** for all new adapters you want to add to your new network.

Figure 21 Making a New Network with the New Adapter

ZYXEL
Your Networking Ally

[G.hn](#)
[IP](#)
[Ethernet](#)
[Device](#)
[Multicast](#)
[Log file](#)

PLA6457 Web Configuration

Basic settings

- MAC address 1c:64:99:c4:cd:6b
- Device ID 1
- Domain Name NewDomainName ✕
- Force node Type AUTOMATIC ▼
- Node type* DOMAIN_MASTER

* Node type change can take some time, please refresh page to update state

- G.hn profile PLC 100 MHz MIMO BOOST ▼

Encryption Configuration

- Encryption is ENABLED
- Pairing password ****

- Automatic configuration*:

* Pairing can take some time, please refresh page to update state

Available Connections

Device ID	MAC Address	Phy Tx (Mbps)	Phy Rx (Mbps)
<i>Empty list</i>			

- 3 After you have set up a new network, you are ready to connect each PLA on your new network to devices, for example, a computer or a games console.

CHAPTER 5

Troubleshooting

This chapter offers some suggestions to solve problems you might encounter.

5.1 Power and Light Problems

The PLA does not turn on. None of the lights turn on.

- 1 Disconnect and re-connect the PLA.
- 2 Remove the PLA from the outlet. Then connect an electrical device that you know works into the same power outlet. This checks the status of the power outlet.
- 3 If the problem continues, contact the vendor.

The ETHERNET light does not turn on.

- 1 Check the hardware connections. See the Quick Start Guide.
- 2 Inspect your cables for damage. Contact the vendor to replace any damaged cables.
- 3 Check the Ethernet adapter on your computer and make sure it is enabled and working properly.
- 4 If the PLA is connected to an Ethernet switch or router, make sure the device is working correctly, and that the LAN network is working and configured correctly as well.

The Powerline light does not turn on.

- 1 Make sure the adapter is plugged in to a power socket and the power socket is turned on.
- 2 Use the Web Configurator to detect all other PLAs on your G.hn Network. Make sure that the domain name (sometimes called the network password) is the same on all of your PLAs. See [Section 3.4 on page 20](#) for instructions on changing the network name.
- 3 Check the MAC address for all PLAs are shown correctly in the Web Configurator. See [Section 3.6 on page 23](#) for instructions on checking the MAC address.

- 4 Make sure that all your PLAs are G.hn compliant. Check the package it came in or ask your vendor. This PLA cannot detect earlier versions of G.hn PLAs such as G.hn 1.0 or 1.0.1. (Although they can coexist on the same electrical wiring without interfering with each other.)
- 5 Make sure that the PLAs on your network are all on the same electrical wiring. Connect another PLA into an outlet close to your PLA's power outlet. They are probably now on the same electrical wiring. Check the Powerline () light. If it now lights up your PLA was probably previously on separate electrical wiring. Ask an electrician for more information on the electrical wiring in your building.
- 6 Make sure that you do not have a power meter between PLAs. Powerline signals cannot pass this.

The Power and Powerline light blink at the same time indicating an error in pairing.

You have pressed the **ENCRYPT** button for more than 5 seconds. Try setting up a connection again, this time pressing the **ENCRYPT** buttons on both devices for less than 5 seconds.

5.2 Web Configurator Problems

The Web Configurator does not display all or any of my devices.

Inspect the LEDs on your PLA and make sure that the ETHERNET and Powerline LEDs are on or blinking. See [Section 1.2 on page 8](#) for troubleshooting LED related problems.

I don't know the IP address of the PLA.

There is no default fixed management IP address for the PLA. You need to log into your router to see the IP address the router gave to the PLA.

Follow this procedure if you cannot log into the router to see the assigned IP address.

- 1 Connect your PLA to your router's LAN port using an Ethernet cable.
- 2 Connect the router's LAN port to your computer's LAN port using another Ethernet cable.
- 3 Download an IP scanner software, such as Advanced IP Scanner, and use it to scan the IP address used. The IP address list should include the IP addresses of the router, the PLA, and the computer connected to the router.

If you want to assign a static IP address to your PLA, please follow the instructions below.

- 1 Type the IP address of the PLA using an Internet browser to log into the PLA's Web Configurator. After logging into the Web Configurator, go to the **IP** screen.

- 2 Under **IPv4 Configuration**, disable **DHCP enable** and then assign an IP in the **IPv4 address** field as the static IP. You can now use this IP address as the default IP address to log into the PLA's Web Configurator.

Note: The static IP must be in the same subnet of the router.

5.3 Powerline Problems

The signal on my G.hn Network is weak.

- 1 Your PLAs cannot be connected to extension cords. Connect them to standard power outlets.
- 2 Your PLAs may be located close to large appliances such as refrigerators or air-conditioners that cause interference with the Powerline signal. Move the adapters further away from such appliances to reduce interference.
- 3 Your PLAs may be placed close to electrical devices such as electrical insect-killers which produce radio waves. These may interfere with the Powerline signals. Move the adapters further away from such electrical devices.
- 4 Your wiring may be old and/or low quality or with a long wiring path.

5.4 ENCRYPT Button Problems

The Power light does not blink when I press the **ENCRYPT** button.

- Check that the device is on.
- Press the **ENCRYPT** button again, making certain you have pressed the button for 2 to 5 seconds.
- For PLA, you cannot use the **ENCRYPT** button when it is in standby mode. Connect the PLA to a computer or router, then try again.

The Power lights on both devices blink when I press the **ENCRYPT** buttons, but the Powerline light does not turn on.

- Ensure you have pressed the **ENCRYPT** buttons on both devices.
- Wait for about a minute while the devices set up a connection.
- If that does not work, try again with both devices connected to a power strip next to each other. If they now connect, then the devices were not on the same electrical circuit before.

The Power lights on both devices blink, then the Powerline light blinks red.

Do not worry, the connection process is proceeding normally.

The Power lights on both devices finished blinking, but only one device's Powerline light is on.

One device may have connected to a third PLA. To check if device A is connected to device B and not to device C, disconnect device B from its power source. Device A's Powerline () light will turn off if the connection is with device B and stay on if it is with device C. Disconnect device A from device C by pressing the **RESET** button on device C for 10 – 15 seconds. And then reconnect device A to device B by pressing the **ENCRYPT** button for 2 to 5 seconds on both devices within 120 seconds.

APPENDIX A

Customer Support

In the event of problems that cannot be solved by using this manual, you should contact your vendor. If you cannot contact your vendor, then contact a Zyxel office for the region in which you bought the device.

See <https://www.zyxel.com/homepage.shtml> and also https://www.zyxel.com/about_zyxel/zyxel_worldwide.shtml for the latest information.

Please have the following information ready when you contact an office.

Required Information

- Product model and serial number.
- Warranty Information.
- Date that you received your device.
- Brief description of the problem and the steps you took to solve it.

Corporate Headquarters (Worldwide)

Taiwan

- Zyxel Communications Corporation
- <https://www.zyxel.com>

Asia

China

- Zyxel Communications (Shanghai) Corp.
- Zyxel Communications (Beijing) Corp.
- Zyxel Communications (Tianjin) Corp.
- <https://www.zyxel.com/cn/zh/>

India

- Zyxel Technology India Pvt Ltd
- <https://www.zyxel.com/in/en/>

Kazakhstan

- Zyxel Kazakhstan
- <https://www.zyxel.kz>

Korea

- Zyxel Korea Corp.
- <http://www.zyxel.kr>

Malaysia

- Zyxel Malaysia Sdn Bhd.
- <http://www.zyxel.com.my>

Pakistan

- Zyxel Pakistan (Pvt.) Ltd.
- <http://www.zyxel.com.pk>

Philippines

- Zyxel Philippines
- <http://www.zyxel.com.ph>

Singapore

- Zyxel Singapore Pte Ltd.
- <http://www.zyxel.com.sg>

Taiwan

- Zyxel Communications Corporation
- <https://www.zyxel.com/tw/zh/>

Thailand

- Zyxel Thailand Co., Ltd
- <https://www.zyxel.com/th/th/>

Vietnam

- Zyxel Communications Corporation-Vietnam Office
- <https://www.zyxel.com/vn/vi>

Europe

Belarus

- Zyxel BY
- <https://www.zyxel.by>

Belgium

- Zyxel Communications B.V.
- <https://www.zyxel.com/be/nl/>

- <https://www.zyxel.com/be/fr/>

Bulgaria

- Zyxel България
- <https://www.zyxel.com/bg/bg/>

Czech Republic

- Zyxel Communications Czech s.r.o
- <https://www.zyxel.com/cz/cs/>

Denmark

- Zyxel Communications A/S
- <https://www.zyxel.com/dk/da/>

Estonia

- Zyxel Estonia
- <https://www.zyxel.com/ee/et/>

Finland

- Zyxel Communications
- <https://www.zyxel.com/fi/fi/>

France

- Zyxel France
- <https://www.zyxel.fr>

Germany

- Zyxel Deutschland GmbH
- <https://www.zyxel.com/de/de/>

Hungary

- Zyxel Hungary & SEE
- <https://www.zyxel.com/hu/hu/>

Italy

- Zyxel Communications Italy
- <https://www.zyxel.com/it/it/>

Latvia

- Zyxel Latvia
- <https://www.zyxel.com/lv/lv/>

Lithuania

- Zyxel Lithuania
- <https://www.zyxel.com/lt/lt/>

Netherlands

- Zyxel Benelux
- <https://www.zyxel.com/nl/nl/>

Norway

- Zyxel Communications
- <https://www.zyxel.com/no/no/>

Poland

- Zyxel Communications Poland
- <https://www.zyxel.com/pl/pl/>

Romania

- Zyxel Romania
- <https://www.zyxel.com/ro/ro>

Russia

- Zyxel Russia
- <https://www.zyxel.com/ru/ru/>

Slovakia

- Zyxel Communications Czech s.r.o. organizacna zlozka
- <https://www.zyxel.com/sk/sk/>

Spain

- Zyxel Communications ES Ltd
- <https://www.zyxel.com/es/es/>

Sweden

- Zyxel Communications
- <https://www.zyxel.com/se/sv/>

Switzerland

- Studerus AG
- <https://www.zyxel.ch/de>
- <https://www.zyxel.ch/fr>

Turkey

- Zyxel Turkey A.S.
- <https://www.zyxel.com/tr/tr/>

UK

- Zyxel Communications UK Ltd.
- <https://www.zyxel.com/uk/en/>

Ukraine

- Zyxel Ukraine
- <http://www.ua.zyxel.com>

South America

Argentina

- Zyxel Communications Corporation
- <https://www.zyxel.com/co/es/>

Brazil

- Zyxel Communications Brasil Ltda.
- <https://www.zyxel.com/br/pt/>

Colombia

- Zyxel Communications Corporation
- <https://www.zyxel.com/co/es/>

Ecuador

- Zyxel Communications Corporation
- <https://www.zyxel.com/co/es/>

South America

- Zyxel Communications Corporation
- <https://www.zyxel.com/co/es/>

Middle East

Israel

- Zyxel Communications Corporation
- <http://il.zyxel.com/>

Middle East

- Zyxel Communications Corporation
- <https://www.zyxel.com/me/en/>

North America

USA

- Zyxel Communications, Inc. - North America Headquarters
- <https://www.zyxel.com/us/en/>

Oceania

Australia

- Zyxel Communications Corporation
- <https://www.zyxel.com/au/en/>

Africa

South Africa

- Nology (Pty) Ltd.
- <https://www.zyxel.com/za/en/>

APPENDIX B

Legal Information

Copyright

Copyright © 2021 by Zyxel and/or its affiliates.

The contents of this publication may not be reproduced in any part or as a whole, transcribed, stored in a retrieval system, translated into any language, or transmitted in any form or by any means, electronic, mechanical, magnetic, optical, chemical, photocopying, manual, or otherwise, without the prior written permission of Zyxel and/or its affiliates.

Published by Zyxel and/or its affiliates. All rights reserved.

Disclaimer

Zyxel does not assume any liability arising out of the application or use of any products, or software described herein. Neither does it convey any license under its patent rights nor the patent rights of others. Zyxel further reserves the right to make changes in any products described herein without notice. This publication is subject to change without notice.

Regulatory Notice and Statement

EUROPEAN UNION



The following information applies if you use the product within the European Union.

List of national codes

COUNTRY	ISO 3166 2 LETTER CODE	COUNTRY	ISO 3166 2 LETTER CODE
Austria	AT	Liechtenstein	LI
Belgium	BE	Lithuania	LT
Bulgaria	BG	Luxembourg	LU
Croatia	HR	Malta	MT
Cyprus	CY	Netherlands	NL
Czech Republic	CZ	Norway	NO
Denmark	DK	Poland	PL
Estonia	EE	Portugal	PT
Finland	FI	Romania	RO
France	FR	Serbia	RS
Germany	DE	Slovakia	SK
Greece	GR	Slovenia	SI
Hungary	HU	Spain	ES
Iceland	IS	Switzerland	CH
Ireland	IE	Sweden	SE
Italy	IT	Turkey	TR
Latvia	LV	United Kingdom	GB

Safety Warnings

- Do not use this product near water, for example, in a wet basement or near a swimming pool.
- Do not expose your device to dampness, dust or corrosive liquids.

- Do not store things on the device.
- Do not obstruct the device ventilation slots, as insufficient airflow may harm your device. For example, do not place the device in an enclosed space such as a box or on a very soft surface such as a bed or sofa.
- Do not install, use, or service this device during a thunderstorm. There is a remote risk of electric shock from lightning.
- Connect ONLY suitable accessories to the device.
- Do not open the device or unit. Opening or removing covers can expose you to dangerous high voltage points or other risks. ONLY qualified service personnel should service or disassemble this device. Please contact your vendor for further information.
- Make sure to connect the cables to the correct ports.
- Place connecting cables carefully so that no one will step on them or stumble over them.
- Always disconnect all cables from this device before servicing or disassembling.
- Do not remove the plug and connect it to a power outlet by itself; always attach the plug to the power adaptor first before connecting it to a power outlet.
- Do not allow anything to rest on the power adaptor or cord and do NOT place the product where anyone can walk on the power adaptor or cord.
- Please use the provided or designated connection cables/power cables/ adaptors. Connect it to the right supply voltage (for example, 110 V AC in North America or 230 V AC in Europe). If the power adaptor or cord is damaged, it might cause electrocution. Remove it from the device and the power source, repairing the power adapter or cord is prohibited. Contact your local vendor to order a new one.
- Do not use the device outside, and make sure all the connections are indoors. There is a remote risk of electric shock from lightning.
- CAUTION: Risk of explosion if battery is replaced by an incorrect type, dispose of used batteries according to the instruction. Dispose them at the applicable collection point for the recycling of electrical and electronic devices. For detailed information about recycling of this product, please contact your local city office, your household waste disposal service or the store where you purchased the product.
- The following warning statements apply, where the disconnect device is not incorporated in the device or where the plug on the power supply cord is intended to serve as the disconnect device.
 - For permanently connected devices, a readily accessible disconnect device shall be incorporated external to the device;
 - For pluggable devices, the socket-outlet shall be installed near the device and shall be easily accessible.

Environment Statement

Disposal and Recycling Information

The symbol below means that according to local regulations your product and/or its battery shall be disposed of separately from domestic waste. If this product is end of life, take it to a recycling station designated by local authorities. At the time of disposal, the separate collection of your product and/or its battery will help save natural resources and ensure that the environment is sustainable development.

Die folgende Symbol bedeutet, dass Ihr Produkt und/oder seine Batterie gemäß den örtlichen Bestimmungen getrennt vom Hausmüll entsorgt werden muss. Wenden Sie sich an eine Recyclingstation, wenn dieses Produkt das Ende seiner Lebensdauer erreicht hat. Zum Zeitpunkt der Entsorgung wird die getrennte Sammlung von Produkt und/oder seiner Batterie dazu beitragen, natürliche Ressourcen zu sparen und die Umwelt und die menschliche Gesundheit zu schützen.

El símbolo de abajo indica que según las regulaciones locales, su producto y/o su batería deberán depositarse como basura separada de la doméstica. Cuando este producto alcance el final de su vida útil, llévelo a un punto limpio. Cuando llegue el momento de desechar el producto, la recogida por separado éste y/o su batería ayudará a salvar los recursos naturales y a proteger la salud humana y medioambiental.

Le symbole ci-dessous signifie que selon les réglementations locales votre produit et/ou sa batterie doivent être éliminés séparément des ordures ménagères. Lorsque ce produit atteint sa fin de vie, amenez-le à un centre de recyclage. Au moment de la mise au rebut, la collecte séparée de votre produit et/ou de sa batterie aidera à économiser les ressources naturelles et protéger l'environnement et la santé humaine.

Il simbolo sotto significa che secondo i regolamenti locali il vostro prodotto e/o batteria deve essere smaltito separatamente dai rifiuti domestici. Quando questo prodotto raggiunge la fine della vita di servizio portarlo a una stazione di riciclaggio. Al momento dello smaltimento, la raccolta separata del vostro prodotto e/o della sua batteria aiuta a risparmiare risorse naturali e a proteggere l'ambiente e la salute umana.



Symbolen innebär att enligt lokal lagstiftning ska produkten och/eller dess batteri kastas separat från hushållsavfallet. När den här produkten når slutet av sin livslängd ska du ta den till en återvinningsstation. Vid tiden för kasseringen bidrar du till en bättre miljö och mänsklig hälsa genom att göra dig av med den på ett återvinningsställe.



About the Symbols

Various symbols are used in this product to ensure correct usage, to prevent danger to the user and others, and to prevent property damage. The meaning of these symbols are described below. It is important that you read these descriptions thoroughly and fully understand the contents.

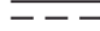
Explanation of the Symbols

SYMBOL	EXPLANATION
	Alternating current (AC): AC is an electric current in which the flow of electric charge periodically reverses direction.
	Direct current (DC): DC is the unidirectional flow or movement of electric charge carriers.
	Earth; ground: A wiring terminal intended for connection of a Protective Earthing Conductor.
	Class II equipment: The method of protection against electric shock in the case of class II equipment is either double insulation or reinforced insulation.

Viewing Certifications

Go to <http://www.zyxel.com> to view this product's documentation and certifications.

Zyxel Limited Warranty

Zyxel warrants to the original end user (purchaser) that this product is free from any defects in material or workmanship for a specific period (the Warranty Period) from the date of purchase. The Warranty Period varies by region. Check with your vendor and/or the authorized Zyxel local distributor for details about the Warranty Period of this product. During the warranty period, and upon proof of purchase, should the product have indications of failure due to faulty workmanship and/or materials, Zyxel will, at its discretion, repair or replace the defective products or components without charge for either parts or labor, and to whatever extent it shall deem necessary to restore the product or components to proper operating condition. Any replacement will consist of a new or re-manufactured functionally equivalent product of equal or higher value, and will be solely at the discretion of Zyxel. This warranty shall not apply if the product has been modified, misused, tampered with, damaged by an act of God, or subjected to abnormal working conditions.

Note

Repair or replacement, as provided under this warranty, is the exclusive remedy of the purchaser. This warranty is in lieu of all other warranties, express or implied, including any implied warranty of merchantability or fitness for a particular use or purpose. Zyxel shall in no event be held liable for indirect or consequential damages of any kind to the purchaser.

To obtain the services of this warranty, contact your vendor. You may also refer to the warranty policy for the region in which you bought the device at http://www.zyxel.com/web/support_warranty_info.php.

Registration

Register your product online at www.zyxel.com to receive email notices of firmware upgrades and related information.

Open Source Licenses

This product may contain in part some free software distributed under GPL license terms and/or GPL-like licenses.

To request the source code covered under these licenses, please go to: https://www.zyxel.com/form/gpl_oss_software_notice.shtml

Index

A

AC pass-through [7](#)
accessing the PLA [29](#)
add
 new adapter [31](#)
 PLA [30](#)
Advanced Encryption Standard, see AES [8](#)
AES [17](#)
AES (Advanced Encryption Standard) [8](#)

B

broadcast suppression [27](#)
 maximum amount allowed [27](#)

C

certifications [44](#)
 viewing [46](#)
configuration screen [23, 25](#)
connect to computer [29](#)
connections overview [10](#)
contact information [38](#)
copyright [44](#)
customer support [38](#)

D

data capture interval [28](#)
device ID [19](#)
device name [24](#)
Device screen [23](#)
DHCP client [18](#)
DHCP-enabled router [21](#)

disclaimer [44](#)
DNS [21](#)
Domain Name [31](#)
 security [11](#)
domain name [10, 31](#)
 criteria [29](#)
 default [20](#)
 HomeGrid [10](#)
 unknown [12, 15](#)
duplex setting [23](#)

E

electrical circuit boundaries [17](#)
ENCRYPT button [7, 9, 10, 14](#)
 manage [9](#)
 overview [12](#)
 problem [36](#)
 working requirement [12](#)
ENCRYPT connection procedure [13](#)
ENCRYPT feature [10, 12](#)
encrypted pairing
 setting up [10](#)
encrypted pairing LED behavior [12](#)
encryption [8, 17](#)
Encryption configuration [20](#)
Ethernet activity
 no detection [23](#)
Ethernet connection
 inactivity [23](#)
Ethernet port
 number of [7](#)
Ethernet screen [22](#)
expand the network [9](#)

F

firmware upgrade [25](#)
firmware version [24](#)
FTP server [28](#)
FTP server password [28](#)
Full duplex [23](#)

G

G.hn [7](#)
G.hn network [7](#)
 join [12](#)
 setup [12](#)
G.hn profile [20](#)
G.hn screen [19](#)
G.hn standard [10](#)
gateway IP address
 PLA [21](#)

H

Half duplex [23](#)
hardware information
 PLA [24](#)
hardware reset [27](#)

I

IGMP [25](#)
IGMP Multicast range [26](#)
IGMP snooping [26](#)
IGMP/MLD [25](#)
IGMP/MLD broadcast report [26](#)
 mode [26](#)
IGMPv2 [25](#)
IGMPv3 [25](#)
inactivity detection mode [23](#)
inactivity time
 detection [23](#)
Internet Group Multicast Protocol (IGMP) [25](#)

introduction [7](#)
IP packets [25](#)
IP screen [20](#)
IPv4 address [21](#)
IPv6 address [22](#)
IPv6 configuration [21](#)

J

Java permission [17](#)
JavaScript [17](#)

L

LED [34](#)
 ENCRYPTED PAIRING [9](#)
 ETHERNET [9](#)
 POWER [8](#)
 POWERLINE [8](#)
LEDs [8](#)
legal information [44](#)
limited warranty [46](#)
local vs. remote adapter [22, 26, 27](#)
Log File screen [27](#)
login
 Web Configurator [18](#)

M

MAC address [22, 24, 26, 27](#)
 Ethernet adapter [24](#)
 PLA [19](#)
manage the PLA [9](#)
management
 multiple networks [11](#)
 overview [17](#)
managing the device
MIMO (multiple input multiple output) channel [20](#)
MLD [25](#)
MLD snooping [26](#)
MLDv2 [25](#)

Multicast configuration [26](#)
multicast group [25](#)
Multicast Listener Discovery (MLD) [25](#)
Multicast screen [25](#)
Multicast settings [25](#)
multiple Powerline networks [11](#)

N

network
 add more PLAs [14](#)
network example [17](#)
network information [19](#)
network name
 change [10](#)
 HomeGrid [18](#)
network security
 prevent compromising [11](#)
network setup
 example [17](#)
new network setup [32](#)

P

pass-through [7](#)
password [24](#)
 for pairing [31](#)
 FTP server [28](#)
 Web Configurator [24](#)
passwords [22, 26, 27](#)
PHY
 internal [23](#)
PHY rate
 maximum [7](#)
PLA
 add to network [13](#)
plug-and-play [17](#)
power and light
 problem [34](#)
power LED behavior [15](#)
power pass-through [7](#)
power saving [23](#)
power saving mode [9](#)

 setup [22](#)
Powerline
 problem [36](#)
Powerline circuit [11](#)
Powerline LED behavior [12, 15](#)
Powerline network
 add devices [12](#)
 create multiple networks [14](#)
priority settings [25, 27](#)
private network [10](#)
problem
 ENCRYPT button [36](#)
 power and light [34](#)
 Powerline [36](#)
 Web Configurator [35](#)
problems and solutions [34](#)

R

receive rate [19](#)
Regulatory Notice and Statement [44](#)
reset
 PLA [25](#)
RESET button [7, 9, 10](#)
 overview [15](#)
reset PLA [27](#)

S

safety warnings [44](#)
security [10, 11, 18](#)
 passwords [10](#)
serial number
 PLA [24](#)
software information [24](#)
standby mode [9](#)
subnet mask
 PLA [21](#)

T

time interval

- data capture [28](#)
- upload to server [28](#)
- transfer rates [8](#)
- transmit rate [19](#)
- troubleshooting [34](#)
- tutorial
 - expand existing Powerline network [29](#)

U

- upload to server interval [28](#)
- uptime
 - PLA [24](#)

W

- warranty [46](#)
 - note [46](#)
- web browser pop-up window [17](#)
- Web Configurator [17, 24](#)
 - password [24](#)
 - problem [35](#)
 - recommended screen resolution [17](#)
 - supported web browsers [17](#)